



Operating instructions



SMARTFOX

Pro Charger

© DAfi GmbH

2022 All rights reserved.

We have checked the contents of this documentation for conformity with the hardware and software described. Nevertheless, deviations, remaining errors and omissions cannot be ruled out, so that we accept no liability for any damage that may arise as a result.

However, the information in this publication is reviewed regularly and any necessary corrections are included in subsequent editions. We are grateful for any suggestions for improvement.

Subject to technical changes

TABLE OF CONTENTS

1	Introduction.....	7
1.1	Foreword.....	7
1.2	Contact details.....	7
1.3	Labelling.....	8
1.4	Technical data.....	9
1.5	Warranty and liability.....	10
1.6	Content and purpose of this documentation.....	11
1.7	Validity.....	11
1.8	Recommendation.....	11
2	Limits of use.....	12
2.1	Intended use.....	12
2.2	Reasonable foreseeable misapplications.....	12
2.3	Application limits.....	13
2.4	Target group and previous knowledge.....	13
2.5	Principle.....	13
3	Security.....	14
3.1	Classification of document conventions.....	14
3.1.1	Warning and safety instructions.....	14
3.1.2	Notes.....	15
3.1.3	Information.....	15
3.2	Signal words and safety instructions used.....	15
3.3	Warning, mandatory and prohibition signs used.....	16
3.3.1	Warning sign.....	16
3.3.2	Commandment sign.....	16
3.3.3	Prohibition sign.....	16
3.4	General safety instructions.....	17
3.5	General provisions.....	17
3.6	Warning, mandatory and prohibition signs on the product.....	19
3.7	Safety elements & temperature monitoring.....	19
4	Commissioning / Start-up.....	20
4.1	Transport.....	20
4.2	Prerequisites for the installation.....	20
4.3	Storage.....	20
4.4	Site.....	20
4.5	Assembly.....	21
4.5.1	Scope of delivery.....	22
4.5.2	Wall mounting & electrical connection.....	23

4.6	Installation guidelines.....	37
4.7	Commissioning	38
4.8	Handover by the operator	38
5	Recommended back-up fuse.....	39
6	Operating mode & charging current limit	40
6.1	"Stand Alone" operation	40
6.2	Standard setting "SMARTFOX bus operation	40
7	Wiring diagram with SF Pro	41
7.1	Connection of a charging station	41
7.2	Connection of several charging stations (max. 5).....	42
7.3	Second control level (SMARTFOX Energy Meter) several charging stations	43
7.4	Connection manual switch (optional).....	44
8	Control via SMARTFOX Pro Energy Management.....	45
8.1	Required articles.....	45
8.2	Registration web portal my.smartfox.at	45
8.3	Add SMARTFOX Pro	47
8.4	Software / Software update.....	49
8.5	Add licence / serial number	50
8.6	Parameterisation SMARTFOX Pro	51
8.7	Further parameterisation.....	55
8.8	Live overview.....	59
8.9	Parameterisation of the weekly timer	61
8.9.1	Example: Integration of switching times "Ready for departure on working days	61
8.9.2	Example: Integration of switching times "outside opening hours.....	64
8.10	" Automatic 1-phase / 3-phase changeover	66
8.11	Charge Stop function (EVU lock).....	67
8.12	Control of several charging stations.....	68
9	Operation	77
9.1	Charging cable	77
9.2	Display elements	78
9.2.1	LED status display	78
9.2.2	Energy meter.....	80
10	Maintenance	81
10.1	Inspection.....	81
10.2	Cleaning.....	82
10.3	Maintenance	82
10.4	Spare and wear parts	83
10.5	Repair	83
10.6	Periodic inspection	84

10.7	Decommissioning	84
10.8	Disassembly	84
10.9	Disposal	85
11	Appendix	86
11.1	Drawings - Drilling template (unit: mm)	86
11.2	Spare and wear parts	87
11.3	List of units	87
11.4	Packaging icons	88
11.5	EU Declaration of Conformity.....	89
11.6	Notes	90

List of figures

Figure 1	CE mark	8
Figure 2	Aligning the drilling template on the wall.....	23
Figure 3	Drilling holes on the wall	24
Figure 4	Mounting the dowels.....	25
Figure 5	Opening the cover.....	26
Figure 6	Removing the connection cable	27
Figure 7	Hole & cable entry from behind	28
Figure 8	<i>Hole & cable entry from below</i>	28
Figure 9	Cable entry supply line from behind.....	29
Figure 10	Cable entry supply line from below	29
Figure 11	Mounting the wallbox on the wall	30
Figure 12	Connecting the supply line to the terminal block - 3-phase connection	31
Figure 13	Connecting the supply line to the terminal block - 1-phase connection.....	32
Figure 14	Checking the correct routing of the connection cable - correct.....	33
Figure 15	Checking the correct routing of the connection cable - incorrect.....	33
Figure 16	Checking the cable glands	34
Figure 17	<i>RS485 connection</i>	34
Figure 18	Connecting the connection cable (LED board)	35
Figure 19	Cover assembly.....	36
Figure 20	Back-up fuse scheme FI + LS	39
Figure 21	Back-up fuse diagram LS-FI	39
Figure 22	Connection diagram with SF Pro - 1 charging station	41
Figure 23	<i>Connection diagram with SF Pro - Multiple charging stations</i>	42
Figure 24	<i>Connection diagram with second control level</i>	43
Figure 24	Control A+ automatic & A+ manual.....	63
Figure 25	Charging cable	77
Figure 26	Drilling template & cardboard (bottom part)	86

List of tables

Table 1 Contact details	7
Table 2 Technical data	9
Table 3 Application limits	13
Table 4 Warning signs	16
Table 5 Commandment signs	16
Table 6 Prohibition signs	16
Table 7 Spare and wear parts	87
Table 8 List of units	87
Table 9 Packaging icons	88

Versions

Version	Date	Description
V2.4	24.02.2022	Operating Instructions SMARTFOX Pro Charger

Copyright ©

This original documentation is protected by copyright. All rights reserved, in particular the right of reproduction and distribution as well as translation. No part of this manual may be reproduced in any form (by photocopy, microfilm or any other process) or stored, processed, duplicated or distributed using electronic systems without written permission from DAfi GmbH. Contraventions may result in penal consequences.

© 2022 DAfi GmbH



1 Introduction

For reasons of easier readability, the usual masculine form of speech is used in these operating instructions for personal nouns and pronouns. However, this does not imply any discrimination against the female gender, but is to be understood as gender-neutral in the sense of linguistic simplification.

With the charging station, you have a product that is state of the art in terms of safety for the operating personnel and operational safety. The charging station may nevertheless present hazards if it is used improperly or not for the intended purpose (see chapter 3 for this). Dangers are indicated by safety instructions throughout the documentation.

1.1 Foreword

This documentation serves to ensure safe working on and with the charging station. It contains safety instructions that must be observed! All persons working on and with the charging station must have the documentation available and observe the information and instructions relevant to them.

The documentation must always be complete and perfectly legible.

DAfi GmbH shall not be liable for technical or typographical defects in this documentation, nor shall any liability be accepted for damage directly or indirectly attributable to the delivery, performance or use of this documentation.

1.2 Contact details

If faults occur in the product, the cause of which you cannot rectify on the basis of this documentation, please contact SMARTFOX Support.

DAfi GmbH
Niedernfritzerstraße 120
5531 Eben im Pongau

T: +43 (0)6458 20 160
support@smartfox.at
www.smartfox.at

Table 1 Contact details



1.3 Labelling

The product is clearly identified by the contents of the type plate.

CE marking acc:

- Directive 2014/35/EU of the European Parliament and of the Council on the making available of electrical equipment designed for use within certain voltage limits
- Directive 2014/30/EU of the European Parliament and of the Council on electromagnetic compatibility
- Directive 2014/53/EU of the European Parliament and of the Council on the making available of radio equipment
- Directive 2011/65/EU of the European Parliament and of the Council on the restriction of the use of certain hazardous substances in electrical and electronic equipment



The product is provided with the CE mark according to the specifications of the European Union for the marking of products.

The corresponding declaration of conformity is available at DAfi GmbH and can be requested.

Figure 1 CE mark



1.4 Technical Data

Order number EAN	0767523866314
Charging point	Type 2 cable, 5m length gross, 4.7m (net), 1.3kW-11kW
Safety element	Integrated 6 mA DC fault current detection
Supply**	1~: 16A3~ : 16A
Backup**	LS 3-pole C 16/20A**; RCD protection type A 30 mA
Rated power***	11 kVA
Hedging	DC fault current detection 6 mA according to ÖVE/ÖNORM EN 61851
Load management / interface / inputs	Modbus RTU via RS485; 12 V enabling contact; digital input for manual switch;
Protection class	IP54; IK10
Supply line	Max. Clamping cross-section 5x10mm ² (suitable for copper and aluminium conductors)
Cable entry	Optionally from below or from behind; M25 and M32 sealing glands
Temperature range	-30°C to +50°C (without direct sunlight)
Dimensions	H 490 x W 274 x D 180mm
Weight	4,5 kg
Housing material	Plastic (polycarbonate housing)
Colour	Front shell white, back blue-grey;

Table 2 Technical data

Further technical data can be found in the respective data sheet, as well as in the appendix to these operating instructions. The data sheets are available online at <http://smartfox.at/downloads.html>.



1.5 Warranty and Liability

The warranty period for the charging station is 2 years and begins with the commissioning. These operating instructions are intended to ensure trouble-free and safe use of the product; compliance with these instructions is a prerequisite for the fulfilment of any warranty claims.

Excluded from the warranty are such defects that arise from arrangement and assembly not carried out by the seller, inadequate set-up, non-observance of the installation requirements and conditions of use, overloading of the parts beyond the performance specified by the seller, negligent or incorrect handling and use of unsuitable operating materials; this also applies to defects that are attributable to material provided by the buyer.

Wear parts according to Annex 11.2 are also excluded from the warranty.

The Seller shall only be liable for damage outside the scope of application of the Product Liability Act if it can be proven that it acted with intent or gross negligence, within the scope of the statutory provisions.

Claims for damages shall lapse in particular in the event of:

- Improper use
- Faulty assembly, electrical and mechanical installation and fusing
- Operating with defective or improperly fitted safety devices and guards.
- Disregarding instructions in this documentation
- Non-use of original spare parts
- Conversions or extensions, if this has not been agreed in writing with DAfi GmbH and approved
- Improperly carried out repairs
- Catastrophic events, foreign body impact and force majeure

The seller is also not liable for damage caused by the actions of third parties, atmospheric discharges, overvoltages and chemical influences. The warranty does not apply to the replacement of parts that are subject to natural wear and tear.

Furthermore, the General Terms and Conditions of Delivery of the Austrian Electrical and Electronic Manufacturers' Association shall apply exclusively to warranty claims and claims for damages. These can be found at www.feei.at or will be sent to you on request. Deliveries are made subject to retention of title.



1.6 Content and purpose of this documentation

This documentation contains relevant information to enable you to work on the product as safely as possible. Observing the instructions in this document serves to avoid dangers and prevent damage to the product. In addition to these operating instructions, the regulations for accident prevention and environmental protection applicable in the country of use and at the installation site must also be observed.

1.7 Validity

This manual is exclusively for the product in question with the identifier SMARTFOX Pro Charger, of the company DAfi GmbH, is valid. The product was placed on the market by DAfi GmbH.

1.8 Recommendation

We recommend that you have repairs and maintenance work carried out either by DAfi GmbH or by our certified SMARTFOX partners, who are familiar with and trained in our products, thus offering you the best possible service.

To report a complaint or repair, use our RMA application at <https://my.smartfox.at/rma-form>.



2 Limits of use

2.1 Intended Use

This charging station is electrical equipment for charging traction batteries of electrically driven vehicles. For charging these vehicles, plug-in devices according to EN 62196 (alternating current charging, mode 3) are used. The charging station is suitable for indoor and outdoor use.

The product has been built according to the state of the art and the recognised safety rules. Nevertheless, its use may result in danger to life and limb of the operator or third parties or impairment of the product and other material assets. Intended use also includes observing the operating instructions and complying with the maintenance requirements. Only use the product when it is in perfect technical condition.

Use the product as intended and in a safety-conscious manner. Have faults and damage that may affect safety rectified immediately by DAfi GmbH or a certified SMARTFOX partner.

2.2 Reasonable foreseeable Misapplications

The charging station must be mounted on a wall or stand (art. no. 0767523866345) and be stationary. The charging station must not be operated when it is loose (not permanently mounted) - as this does not comply with the protection class.

- Dismantling, manipulating or deactivating the safety devices is prohibited.
- No technical changes may be made to the product without consultation with DAfi GmbH or a certified SMARTFOX partner.
- Furthermore, in the event of non-compliance with the intended use, liability and warranty claims are excluded.
- The product may only be operated under the operating conditions specified in the documentation.



2.3 Application limits

Ambient temperature	-30 to +50 °C at 16A -30 to +40 °C at 32A
Site	Interior and exterior (garage, underground car park, exterior wall, car workshop, parking spaces on pillars). Sufficiently load-bearing masonry (for details see chapter 4.5)
Relative humidity	5 to 95 %
Operation	Depending on demand also possible on a daily basis

Table 3 Application limits

To ensure colour fastness, it is recommended to protect the charging station from direct UV and sunlight. In extreme cases, the temperature inside the station may rise, which could result in a reduction in performance or even the pausing of the charging process.

2.4 Target group and Prior knowledge

This documentation is addressed to qualified personnel for installation and commissioning as well as to the user (layman) for operation and maintenance of the product.

User (layman)

Independent operation of the product may only be carried out by laypersons if these

- have read and understood the operating and maintenance instructions,
- have read and understood all safety instructions.

Qualified personnel (electrotechnical specialist)

Commissioning, inspection and configuration work may only be carried out by qualified personnel. The qualified personnel must have read and understood these operating and maintenance instructions. We recommend appropriate certification as a SMARTFOX partner with DAfi GmbH.

Specialist personnel (Certified SMARTFOX Partners)

Commissioning, maintenance, repair, service, inspection, configuration and servicing work may only be carried out by certified SMARTFOX partners. The qualified personnel must have read and understood these operating and maintenance instructions.

2.5 Principle

The product corresponds to the state of the art and the applicable safety and health regulations. Nevertheless, the following hazards may occur in the event of incorrect operation or misuse:

- for life and limb of users or third parties
- for the product and other material assets of the operator
- for the efficient use of the product



3 Security

This documentation is structured according to the applicable EU regulations and contains safety instructions. The operator of the product must receive the necessary safety-related information and also read the documentation. Individuals are responsible for complying with the safety instructions.

This chapter contains a general introduction of the safety instructions, as well as the description of the warning and safety instructions of the safety markings located on the product. Here you will also find important information on accident prevention.

3.1 Classification of document conventions

This document contains the following types of notes:

- Warning and safety instructions
- Notes
- Information

3.1.1 Warning and Safety instructions

This document contains safety instructions that you must observe for your personal safety and to avoid damage to property. Warning and safety instructions draw the user's attention to hazards that can lead to serious physical injury, even death, or to considerable damage to property if the corresponding instructions are not observed.

In the respective chapter, warnings refer to the hazards that apply there. The structure of warnings and safety instructions is identical. Safety instructions and warnings are highlighted by a warning triangle and must be strictly observed.







3.1.2 Notes

Notes contain important information about a product, the handling of the product or the respective part of the documentation to which special attention should be drawn and which, if disregarded, may have adverse consequences which, as a rule, could endanger persons or the product only in exceptional and individual cases. Instructions must always be read carefully and observed to ensure correct operation and function.

3.1.3 Information

Information is additional notes to a section in this manual or about the product, the handling of the product or the respective part of the documentation to which special attention is to be drawn and the observance of which is recommended because of a possible benefit. Information should be read carefully and observed in the interest of optimum use and operation of the product.

3.2 Signal words used and Safety instructions

DANGER	
	Imminent danger. Serious and permanent bodily injury or death.
WARNING	
	Potentially dangerous situation. Serious bodily injury or death.
CAUTION	
	Potentially dangerous situation. Minor injuries or damage to the product.
NOTE	
	Potentially harmful situation. Damage to the product or its surroundings.
INFORMATION	
	Designates Application tips and other especially useful information before the action steps.



3.3 Warning, mandatory and verb signs used

3.3.1 Warning sign



Pictogram	Meaning	Designation
	General warning sign	W001
	Warning of electrical voltage	W012

Table 4 Warning signs

3.3.2 Commandment sign



Pictogram	Meaning	Designation
	General commandment sign	M001
	Follow instructions	M002

Table 5 Commandment signs

3.3.3 Prohibition sign



Pictogram	Meaning	Designation
	General prohibition sign	P001
	Leaning against forbidden	P041

Table 6 Prohibition signs



3.4 General Safety instructions

Even if maximum care is taken in the design and construction of the product and all safety-relevant aspects are taken into account, residual hazards may still exist which have been evaluated by means of a risk assessment.

The following safety rules must be observed during all work on the charging station:

- Unlock
- Secure against switching on again
- Determine freedom from voltage
- Grounding and short-circuiting
- Cover or fence off surrounding live parts.

3.5 General Provisions

Generally apply at Dealing with the product the following
Safety regulations and obligations:

- The product may only be operated when in perfect condition.
- It is prohibited to remove, alter, bypass or bypass any protection, safety or monitoring device.
- It is prohibited to modify or alter the product.
- Malfunctions or damage must be reported to the manufacturer immediately. These must be remedied immediately with original spare parts.
- For any activity other than the intended use in the area of the product, it must be disconnected from the power supply and secured against being switched on again.
- The safety instructions and operating instructions from the documentation of the components used must always be observed.
- All protection, safety and monitoring devices must be regularly checked and maintained by the operator.
- Maintenance work can be requested from DAfi GmbH and must be carried out by them or a certified SMARTFOX partner.
- After maintenance or repair, the product may only be put into operation with all guards fitted.
- The national safety and accident prevention regulations apply to the operation of the product.



NOTE	
	<p>Malfunction of the product</p> <p>Ensure cleanliness and purity in the area of the product. All objects and containers not required for the function must be removed from the area of the product.</p>

NOTE	
	<p>Lighting at the workplace</p> <p>For maintenance, repair and adjustment work, it may be necessary to equip the work area with an additional light source.</p>

NOTE	
	<p>Putting down tools</p> <p>No objects or tools may be placed on the product. The exception to this is the tools required for assembly, which must be removed before commissioning.</p>



3.6 Warning, mandatory and prohibition signs at Product

Safety instructions are attached to the product and the product inserts, which draw attention to dangers / residual dangers.

The instructions on the safety label on the product must be followed under all circumstances. If, in the course of the product's service life, the safety labels fade or become damaged, they must be replaced immediately with new labels. The legibility and completeness must be checked at regular intervals. From the time when the signs are not immediately recognisable and comprehensible at first glance, the product must be taken out of service until the new signs are installed.

3.7 Safety elements & Temperature monitoring

The product is equipped with the following safety features:

- 6 mA DC fault current detection
- Monitoring the protective conductor connection to the vehicle
- Glass tube fuse for control electronics

The charging station permanently measures the internal temperature. If the SMARTFOX Pro Charger is exposed to direct sunlight or is installed in a particularly exposed location (possible surface temperatures $> 50\text{ }^{\circ}\text{C}$), it is possible that the charging current will be reduced or the charging paused for a short time in order to protect the temperature limits of the installed components.

If the charge controller detects a sufficient drop in the interior temperature, the charging process continues.



4 Commissioning / Commissioning

Commissioning is covered in the following chapters. This includes requirements for transport, storage, the installation site, assembly and commissioning.

4.1 Transport

The product is usually delivered to the customer by DAfi GmbH.

If the product is not delivered by DAfi GmbH or transported by the customer, appropriate packaging (original packaging) as well as a suitable transport company must be chosen for the transport. The assembly work of the product may only be carried out by a qualified, electrotechnical specialist. Moving parts must be secured accordingly. Sensitive parts must be protected from external influences with cardboard packaging or similar material. The product must first be taken out of operation as described in chapter 10.7.

4.2 Requirements for the installation

- Contact on site for the mains disconnection device in the electrical distribution board.
- Prepared sufficiently dimensioned and fused supply line (see chapter 1.4).
- If the temperature changes by more than 15 °C between transport and installation site, condensation may have formed. Wait with the installation until the temperature of the charging station corresponds to the room temperature and the condensation has evaporated again.
- Direct commissioning without acclimatisation time can lead to damage.

4.3 Storage

The following points must be observed when storing the product.

- Depending on the environmental conditions, the product must be protected accordingly.
- In the case of storage with an ambient temperature below 5 °C, special precautions must be taken against frost damage, especially to the electrical components.
- The product must be stored in a dry environment.

4.4 Site

- Ensure that the installation site is level, vibration-free and free from contamination.



- The place of use must be designed for the weight of the product. In addition to its own weight, the load caused by the unplugging and plugging process (dynamics) must be taken into account.
- The product is installed by qualified personnel from DAfi GmbH or an electrotechnical specialist.
- Prepared, sufficiently dimensioned and fused supply line (see chapter 1.4)

4.5 Assembly

WARNING



During assembly work, there are additional dangers due to improper work.

If the product is not installed correctly, it can cause damage or danger to persons and property.

- Installation work may only be carried out by a qualified electrician.

The following points must be observed when mounting the product:

- Before setting up the product, it must be checked for completeness and transport damage. Any deviations must be reported to DAfi GmbH immediately.
- Subsequent complaints can no longer be considered.
- The product must be mounted securely and vertically on a solid and vibration-free surface.
- Supply lines must be protected in accordance with currently valid laws and standards.

NOTE



Backup fuse

Refer to the data sheet of your charging station or chapter 5 for the recommended back-up fuse.

If necessary, the back-up fuse must be dimensioned differently. shutdown conditions to be taken into account.



4.5.1 Scope of delivery

All SMARTFOX Pro Charger charging stations come with the following accessories:

Assembly set consisting of:

- 4x rubber cover cap (1)
- Cable sealing gland:
M20, M25, M32 one piece each (2)
- 1x sealing stage nipple for supply line from behind (3)
- Drilling template (cardboard inside) (4)
- 4x housing screws - stainless steel (5)

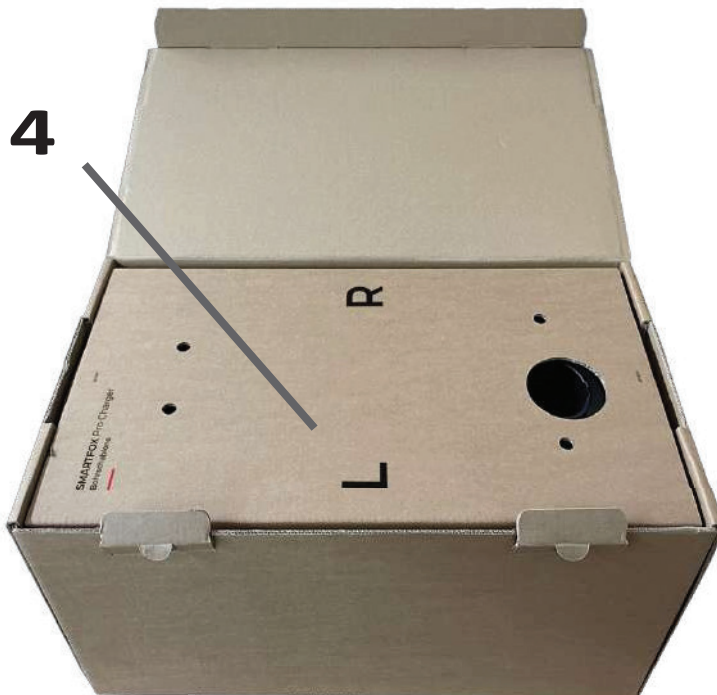
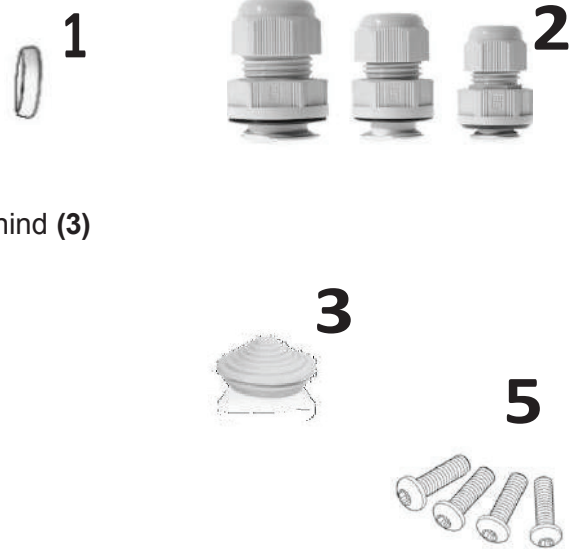

Accessories Box





4.5.2 Wall mounting & electrical connection

This chapter describes the wall mounting of the charging station.

1. Place the drilling template and a spirit level on the wall.
2. Make sure that the template is perpendicular.
3. Mark the holes for the drillings on the wall. If the supply is from behind, make sure that the recess provided for this purpose in the drilling template is placed above the area of the wall outlet. A centre line can be marked on the wall through the notches in the drilling template. This serves to align the wallbox straight during installation.

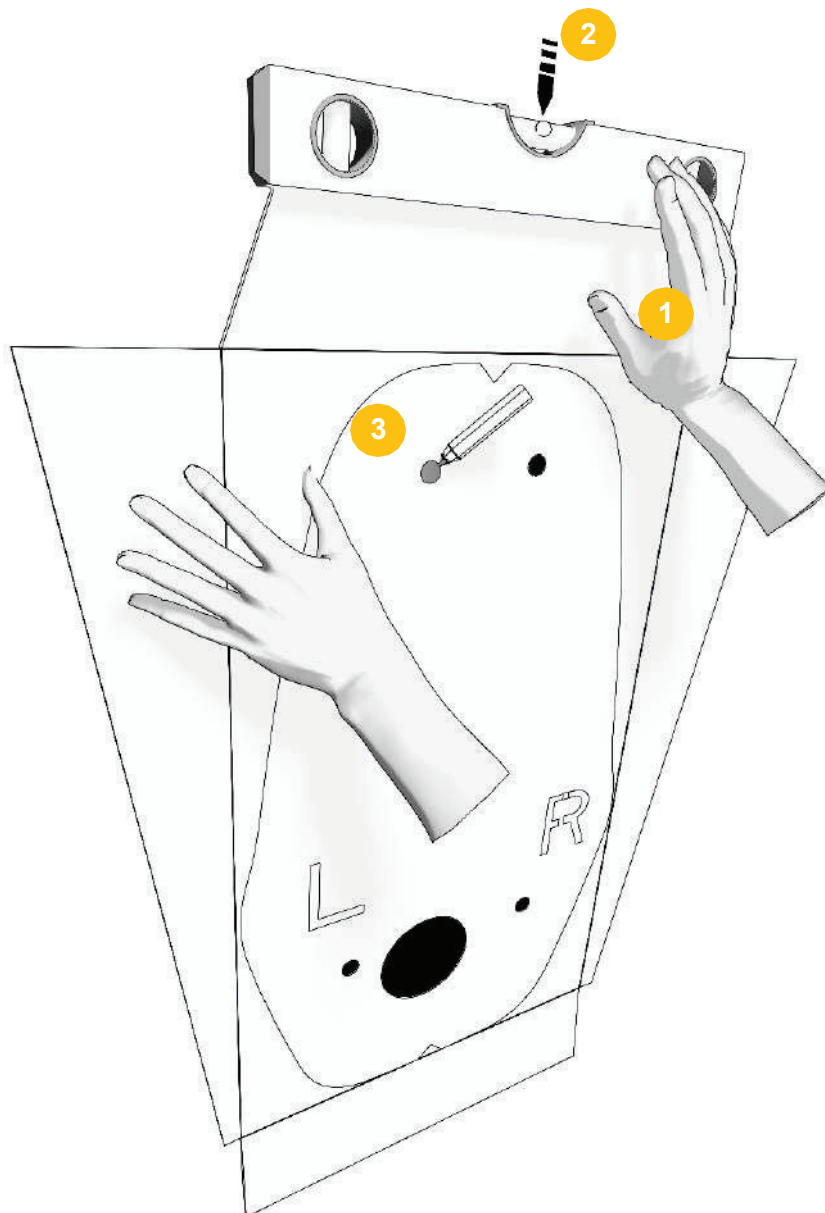

Figure 2 Aligning the drilling template on the wall



Drill the four marked holes at the marked points with a drill using a drill suitable for the wall construction.

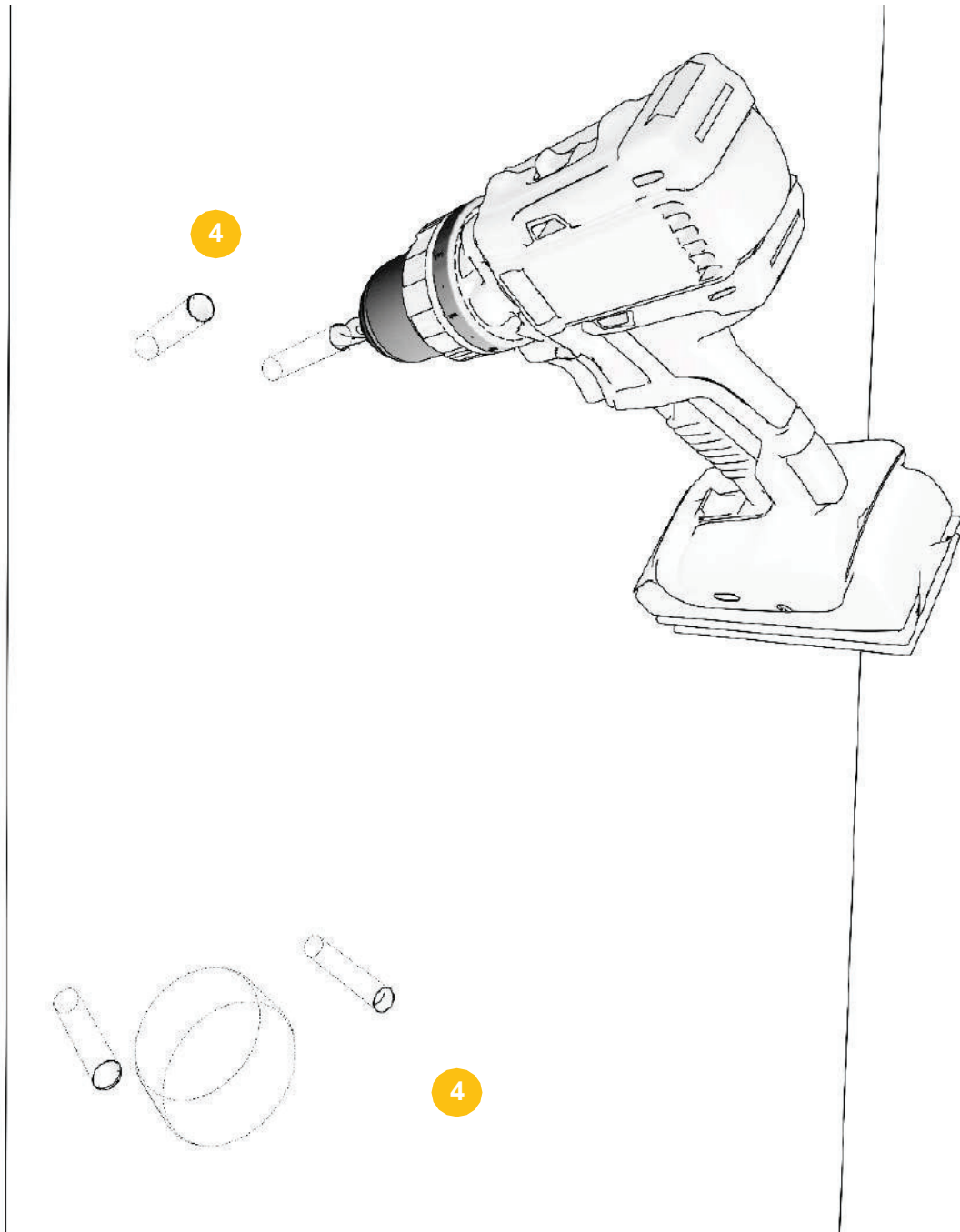

Figure 3 Drilling holes on the wall



4. Insert four dowels into the holes provided as far as they will go.

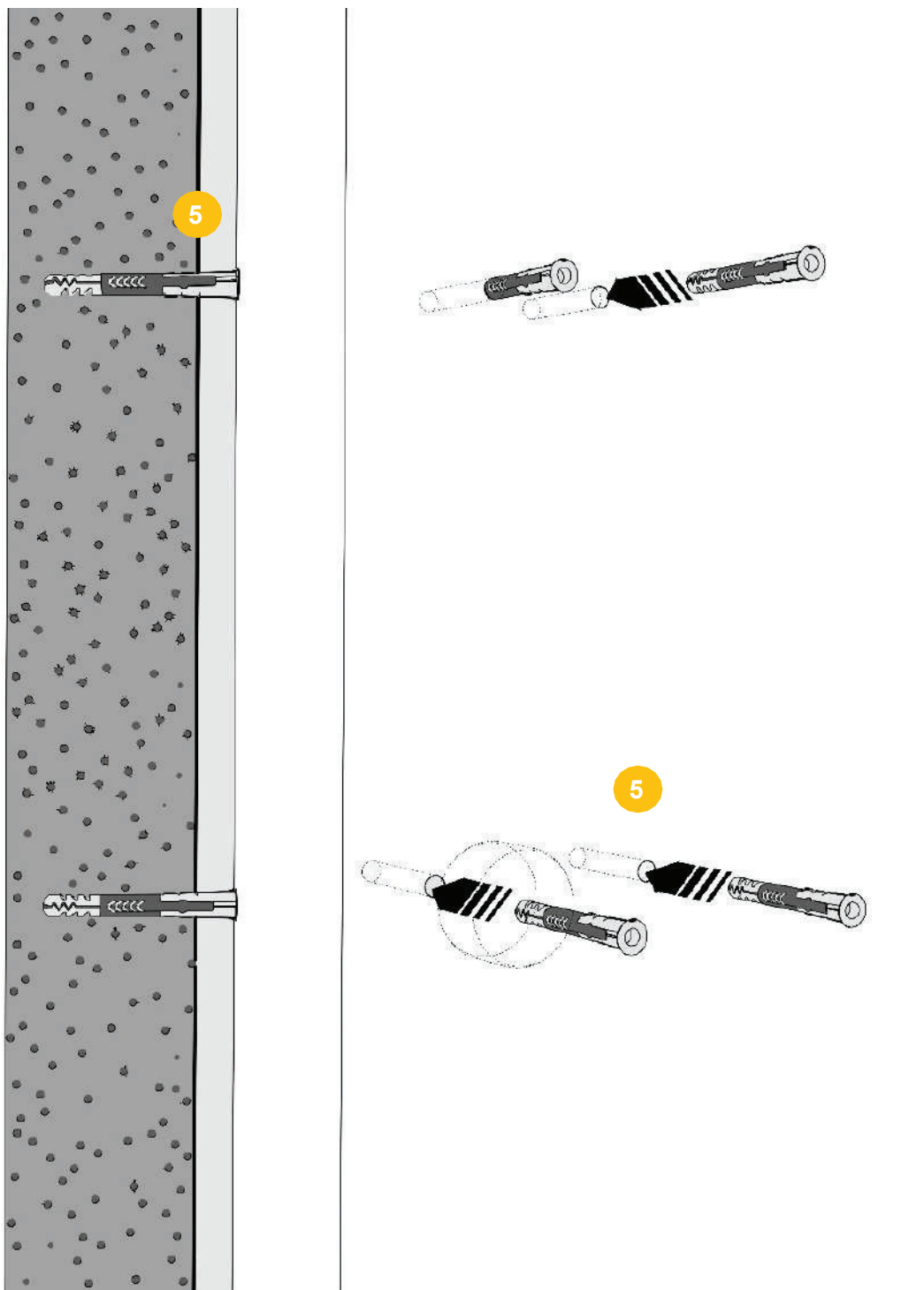

Figure 4 Mounting the dowels



5. Now place the SMARTFOX Wallbox on a clean and dry surface and screw on the four TORX T25 screws with a suitable screwdriver. Be careful not to lose the screws. It is best to put them in the enclosed accessory box with the rest of the screws.



Figure 5 Opening the cover



6. Cable variant - note socket:

When opening the cover, disconnect the connecting cable of the LED board.



Figure 6 Removing the connection cable



7. In the following step, a distinction must now be made between the supply line from behind (a) or below (b), based on the local conditions. Accordingly, the housing feed-throughs must be drilled out with a suitable step drill (c). If necessary, deburr the drill holes. Care must also be taken that no chips remain in the charging station. For the supply line from below, pay attention to the outer diameter of the supply line cable so that the appropriate cable gland (M25 or M32) is used. For the supply cable from the rear, the gland for M25 to be drilled out. The sealing stopper is suitable for supply lines up to 21 mm outer diameter.

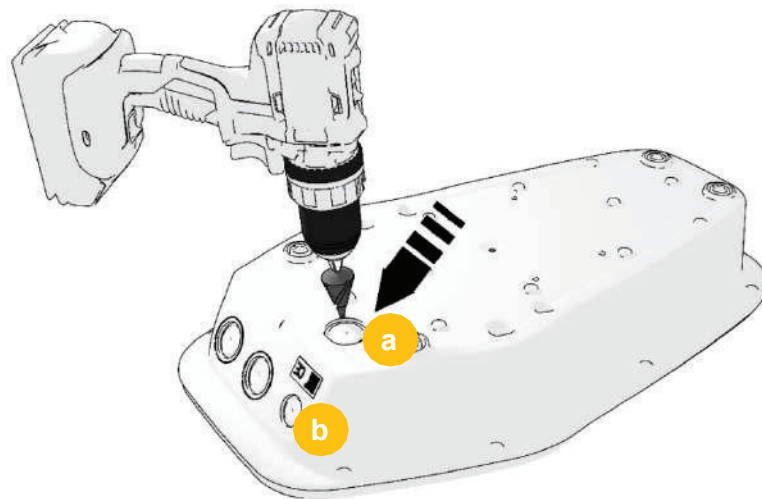

Figure 7 Hole & cable entry from behind

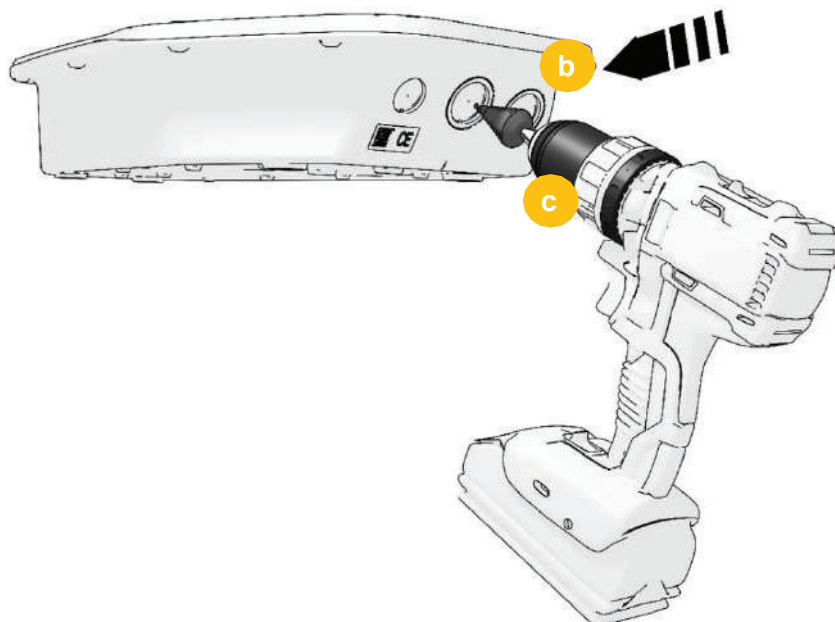

Figure 8 Hole & cable entry from below



8. Now insert the supply cable and the cable of the RS485 connection into the station, according to the drilled openings from behind or below.
Make sure that the cable entry is correct and complies with the legal requirements (sheath incl. minimum cable length for proper connection).



Figure 9 Cable entry supply line from behind

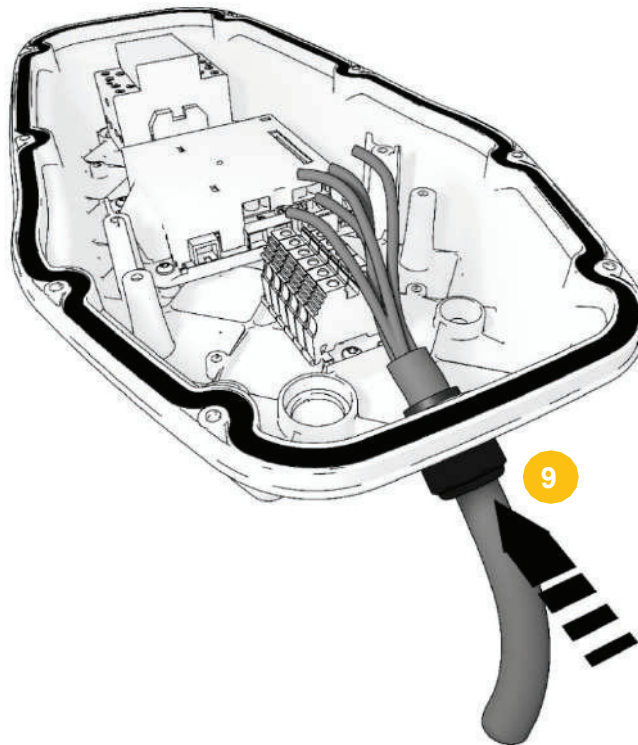
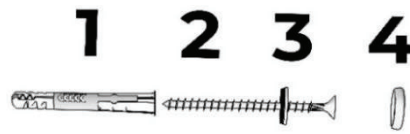

Figure 10 Cable entry supply line from below



9. Now you can mount the wallbox on the wall. Observe the order of installation below:

1. Dowel
2. Screw
3. Sealing washer
4. Rubber cover cap



Prepare the four screws incl. the sealing washers for installation (not included in the scope of delivery). Hold the wallbox against the wall and temporarily screw the two upper screws to the wall using a Torx T30 screwdriver. Repeat this step with the two lower screws and note the centre line previously drawn to align the wallbox straight. Now tighten the screws crosswise with a torque of about 3 Nm. In the last step, place the rubber caps over the screws. These rubber caps are required for compliance with protection class II.

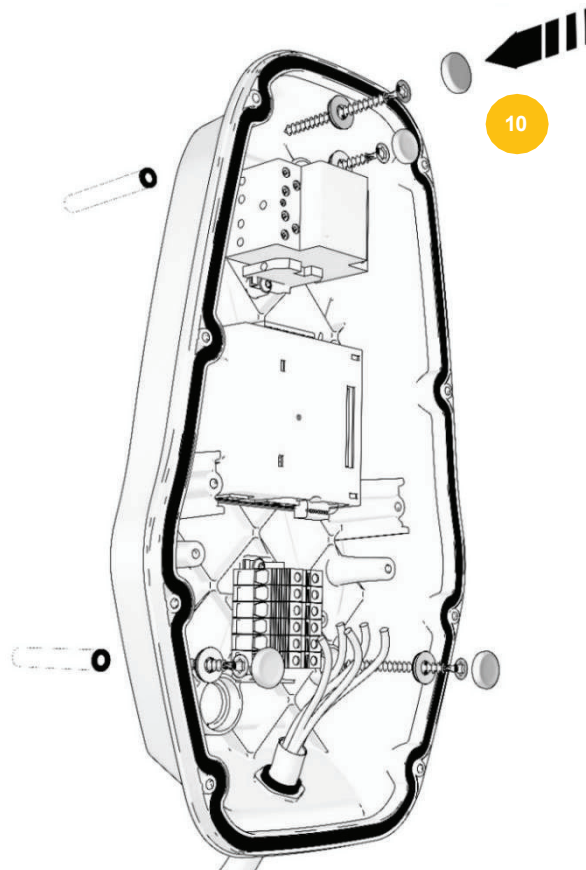

Figure 11 Mounting the wallbox on the wall



10. Now connect the supply line to the terminal block. Pay attention to the local conditions and the applicable technical connection requirements (TAEV). Connect the earth conductor (green/yellow), the neutral conductor (blue) and the phases L1, L2 and L3 with a maximum tightening torque of 1.2 Nm.

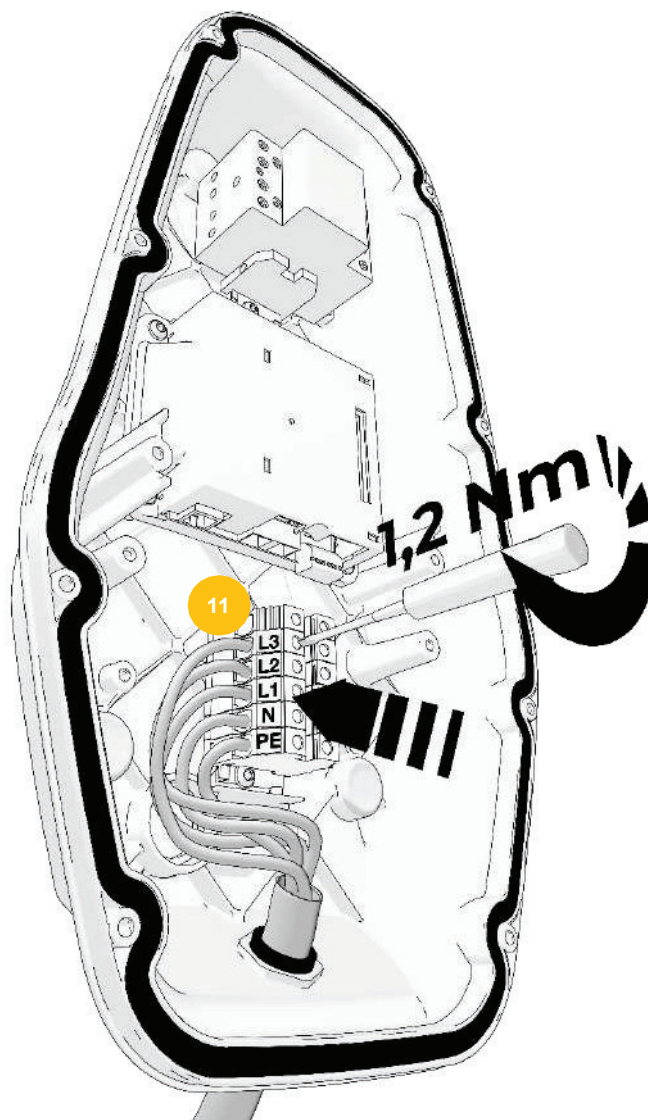

Figure 12 Connecting the supply line to the terminal block - 3-phase connection



INFORMATION	
	<p>Single-phase connection</p> <p>Each charging station can and may also be connected single-phase. For this purpose, the terminals for L2 and L3 are left free - see (12). The screws of the free terminals must nevertheless be tightened. The DIP switches on the charge controller must be set according to the back-up fuse (see chapter Fehler! Verweisquelle konnte nicht gefunden werden.).</p>

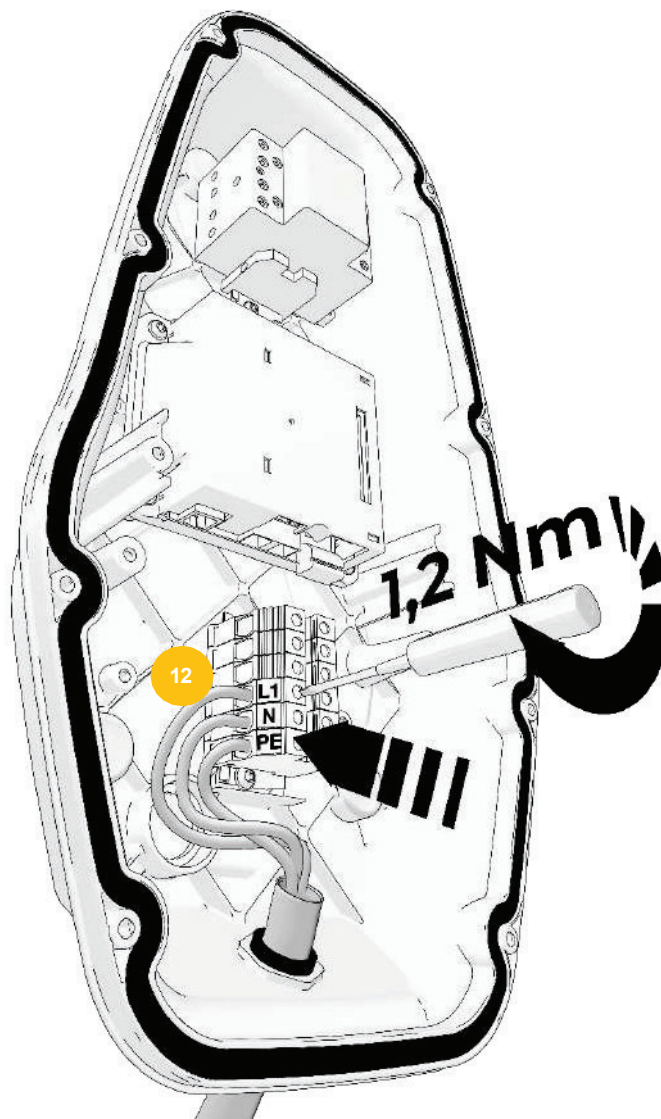

Figure 13 Connecting the supply line to the terminal block - 1-phase connection



11. Check that the connection cable is laid correctly. The connection cable must not run or be laid above the terminal block. This applies to the supply line from behind as well as from below.

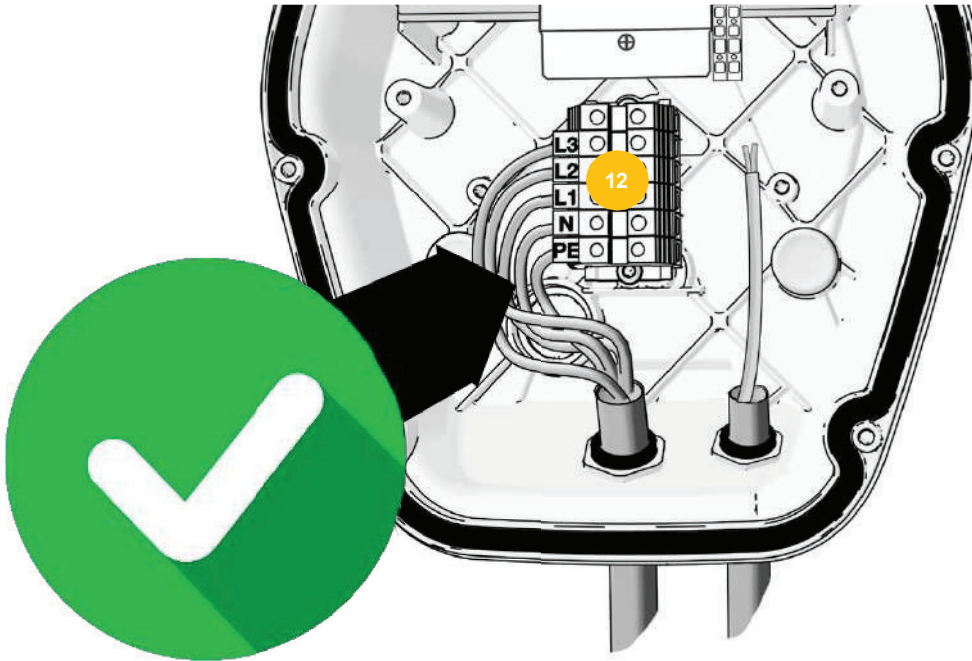

Figure 14 Checking the correct routing of the connection cable - correct

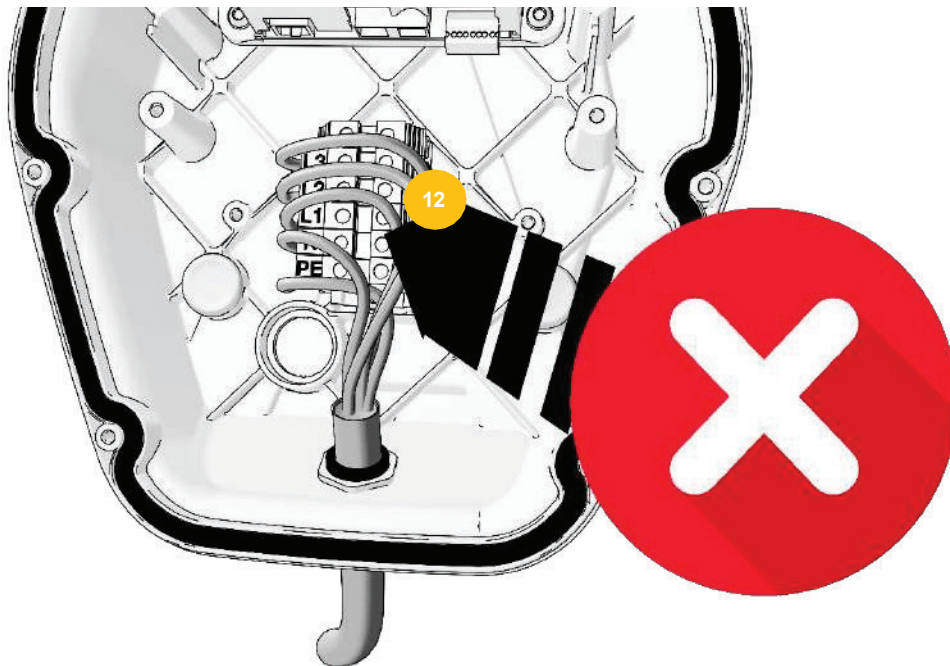

Figure 15 Checking the correct routing of the connection cable - incorrect



12. Check the cable gland of the supply line as well as the RS485 line from below for correct seating. Ensure that the installation is tight and correct. In the case of a supply line from behind, check the step nipple for correct seating to prevent water from entering.

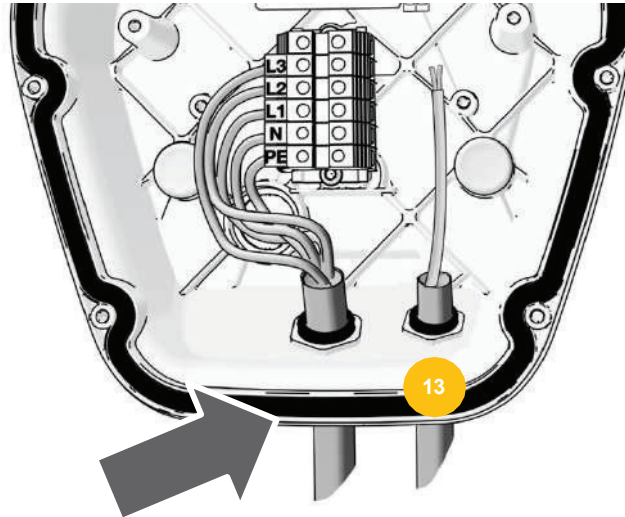

Figure 16 Checking the cable glands

13. Connect the control lines of the RS485 connection to the spring terminals provided according to the designations. (Left D- ; Right D+). Use a twisted pair of wires of a suitable cable, e.g. CAT6 or equivalent. If several charging stations are operated, use the enclosed double insert of the sealing gland.

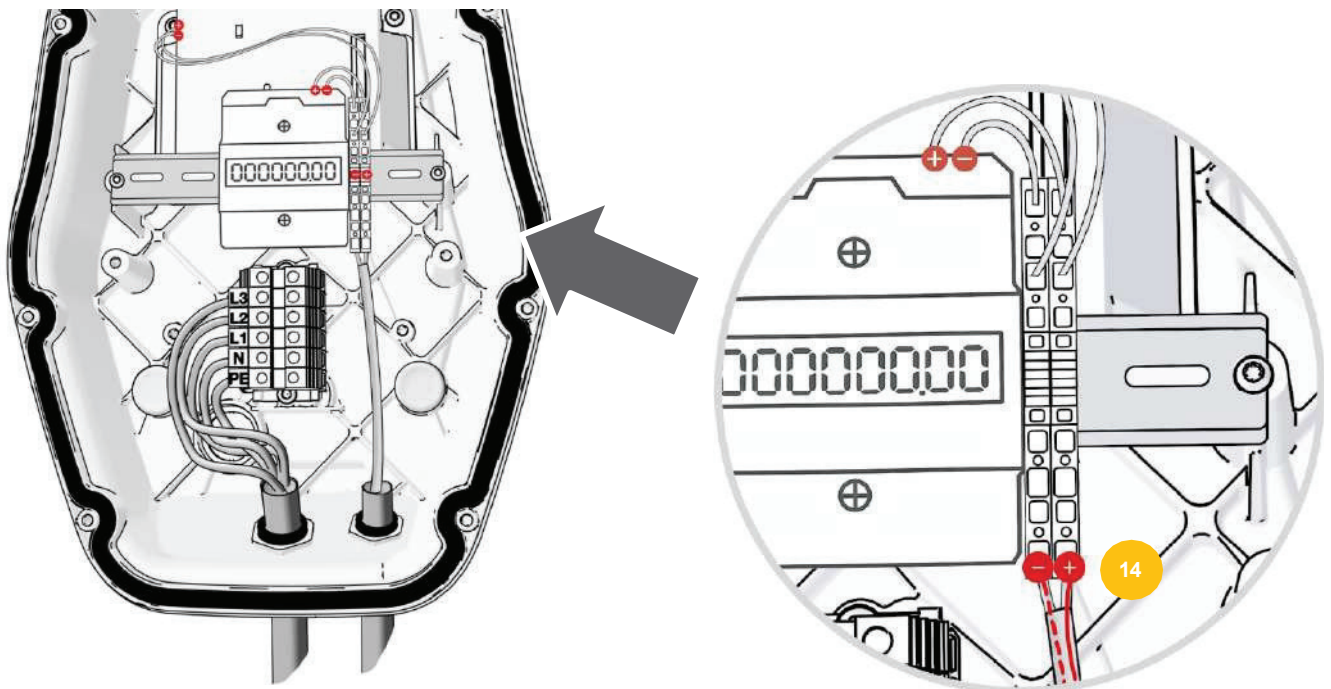

Figure 17 RS485 connection



14. Cable variant:

Opposite to point 7. connect the connection cable of the LED board again in this step.

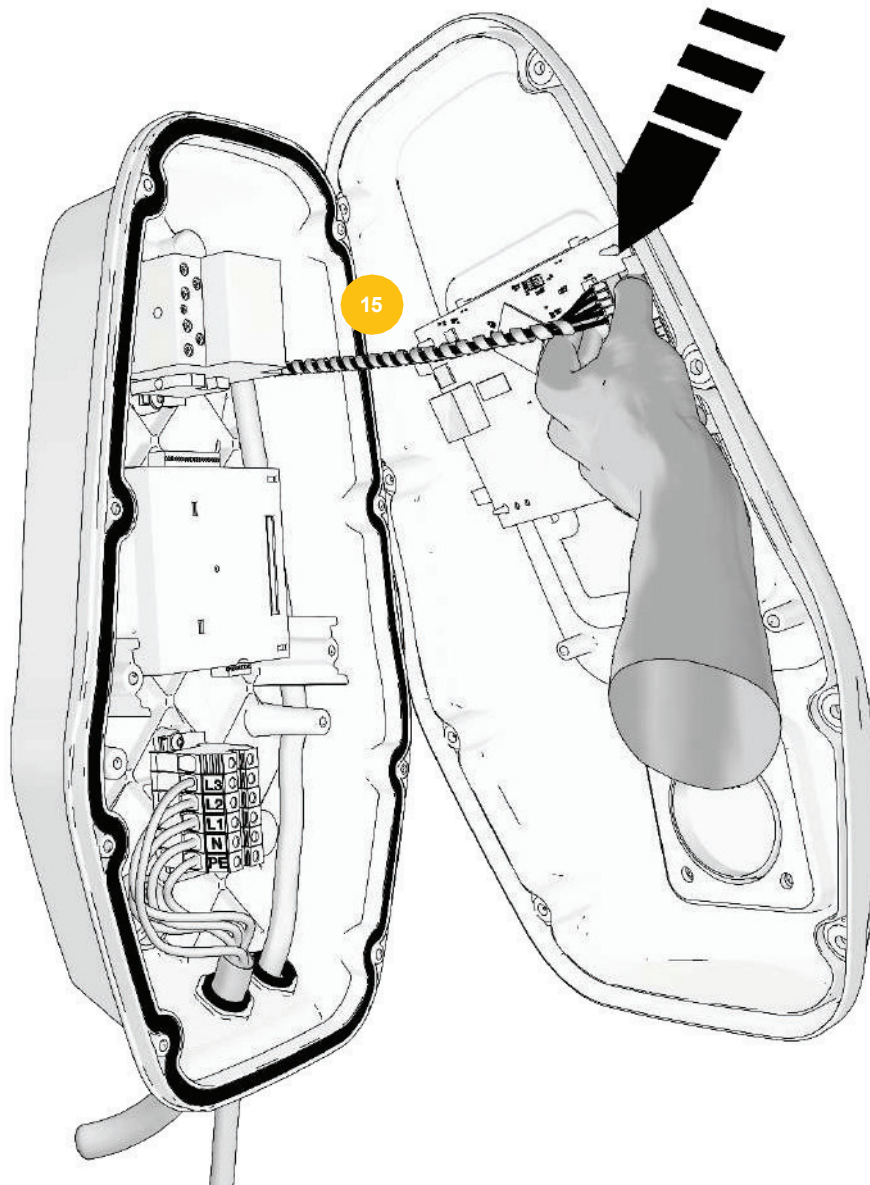

Figure 18 Connecting the connection cable (LED board)



15. Finally, screw all 8 stainless steel screws of the cover into the openings provided. Make sure that the screws are evenly distributed when screwing them on, whereby a maximum tightening torque of 3 Nm should not be exceeded.



Figure 19 Cover assembly



4.6 Installation guidelines

- Observe the locally applicable electrical installation regulations, fire prevention measures and accident prevention regulations.
- The charging station must not be installed in potentially explosive zones (EX environment).
- Mount the charging station in such a way that it is not in the direct flow of people and that no one can trip over the plugged-in or permanently mounted charging cable or that the charging cable does not occupy or cross any pavements.
- Do not install the charging station in places where it is exposed to ammonia or ammonia gases (e.g. in or near stables).
- The mounting surface must have sufficient strength to withstand the mechanical loads.
- Do not mount the charging station in places where falling objects (e.g. suspended objects) can damage the unit.
- According to the product standard, the charging station, in particular the type 2 socket, must be at a height of between 0.4 m and 1.5 m.
- It is recommended to install the charging station (height of socket or parking bay) at a height of 1.2 m to be mounted. Note that national regulations may limit the height.
- The unit must not be exposed to direct jets of water (e.g. from adjacent manual car washes, high-pressure cleaners, garden hoses).
- If possible, the unit should be mounted protected from direct rain, e.g. to avoid icing, damage by hail or the like.
- The unit should be mounted away from direct sunlight to avoid reducing the charging current or interrupting charging due to excessive temperatures on charging station components.



4.7 Commissioning

The commissioning of the product at the customer's site is carried out by qualified personnel from DAFI GmbH or an electrotechnical specialist. All applicable standards and laws must be observed.

4.8 Operator-side Handover

After commissioning of the product, the handover to the customer takes place. The handover takes place with the signing of the test report. With the ready-to-operate handover by the qualified personnel of DAFI GmbH or an electrotechnical specialist to the customer, the responsibility also passes to the customer. Test reports must be prepared in accordance with the requirements of EN 8101.



5 Recommended Backup fuse

Depending on the design, the charging station must be appropriately pre-protected. For this purpose, separate line and residual current circuit breakers can be used as well as a combined circuit breaker, which takes over both tasks of the protective functions in one device.

Three-phase charging stations can and may also be connected and operated as single-phase stations, provided that the charging current does not exceed 16 A (TAEV specification). To do this, carry out the corresponding configuration (see chapter 6).

Other suitable pre-fuses can also be used, provided that the national and country-specific regulations are complied with.

Residual current circuit breaker + miniature circuit breaker:

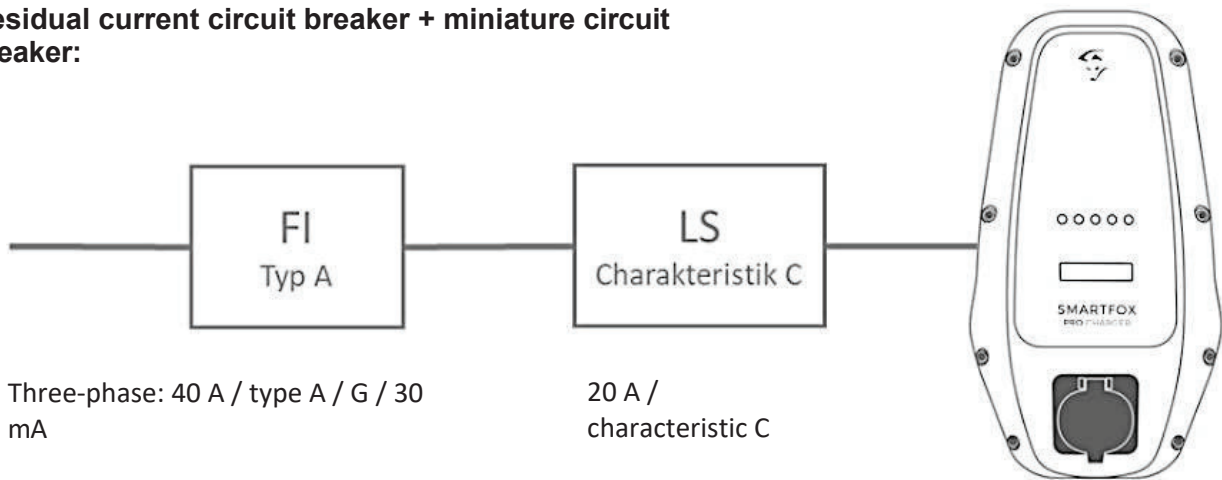

Figure 20 Back-up fuse scheme FI + LS

Combination circuit breaker:

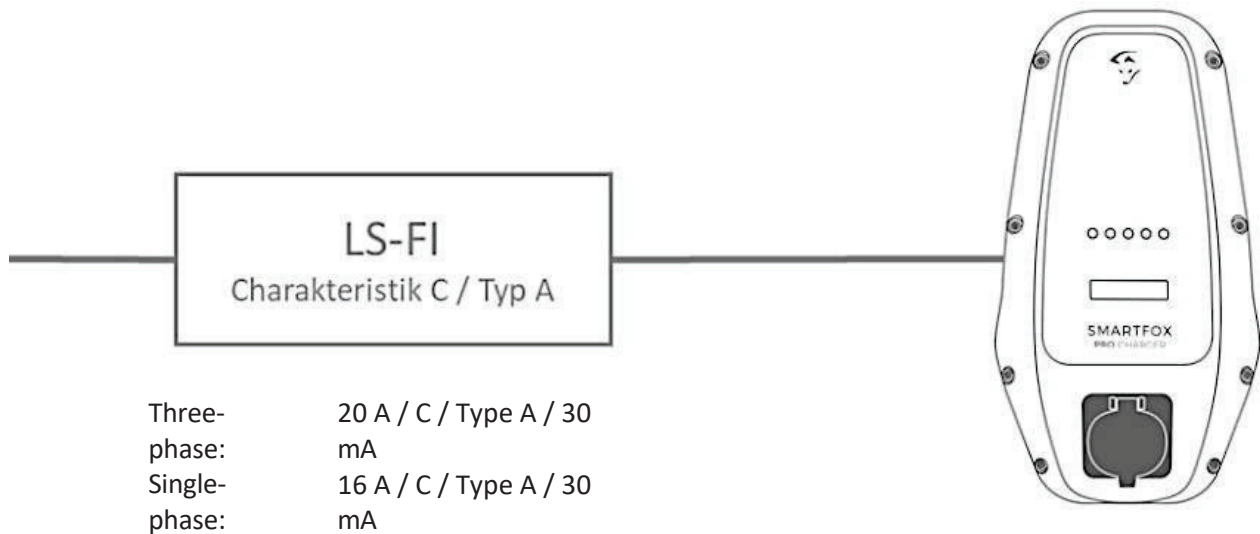
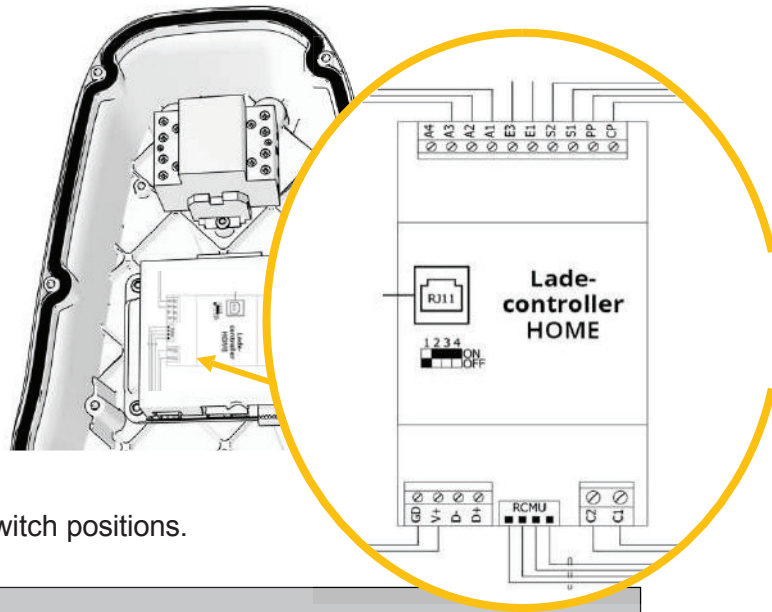

Figure 21 Back-up fuse diagram LS-FI



6 Operating mode & Charging current limit

To use the charging station without an energy management system, "Stand Alone Operation" must be activated. To do this, open the cover of the charge controller and set the DIP switches to the intended positions for "Stand Alone" operation. The charging current can be limited via the other DIP switches.



6.1 "Stand Alone" Operation

The following overview explains the different DIP switch positions.

Operating mode	
	Stand Alone - charging station releases the charge when the vehicle is plugged in Maximum permissible charging current: 16 A
	Stand alone - charging station releases the charge when the vehicle is plugged in Maximum permissible charging current: 13 A

6.2 Default setting "SMARTFOX Bus mode".

Operating mode	
	SMARTFOX bus operation for RS485 Modbus RTU - inputs E1 and E3 are ignored (default setting) Maximum permissible charging current: 16 A
	SMARTFOX bus operation for RS485 Modbus RTU - inputs E1 and E3 are ignored Maximum permissible charging current: 13 A

INFORMATION applicable to point 6.1. and 6.2.



Selecting the charging current

The charging station sets the maximum charging current for the vehicle. The vehicle decides independently how much charging current it will accept based on the battery parameters.

HINWEIS geltend für Punkt 6.1. und 6.2.



DIP-Switch Änderung

Nach einer Änderung der DIP-Switch Konfiguration muss die Ladestation neu gestartet werden. Dadurch werden die neuen Parameter übernommen.

7 Wiring diagram with SF Pro

7.1 Connection of a charging station

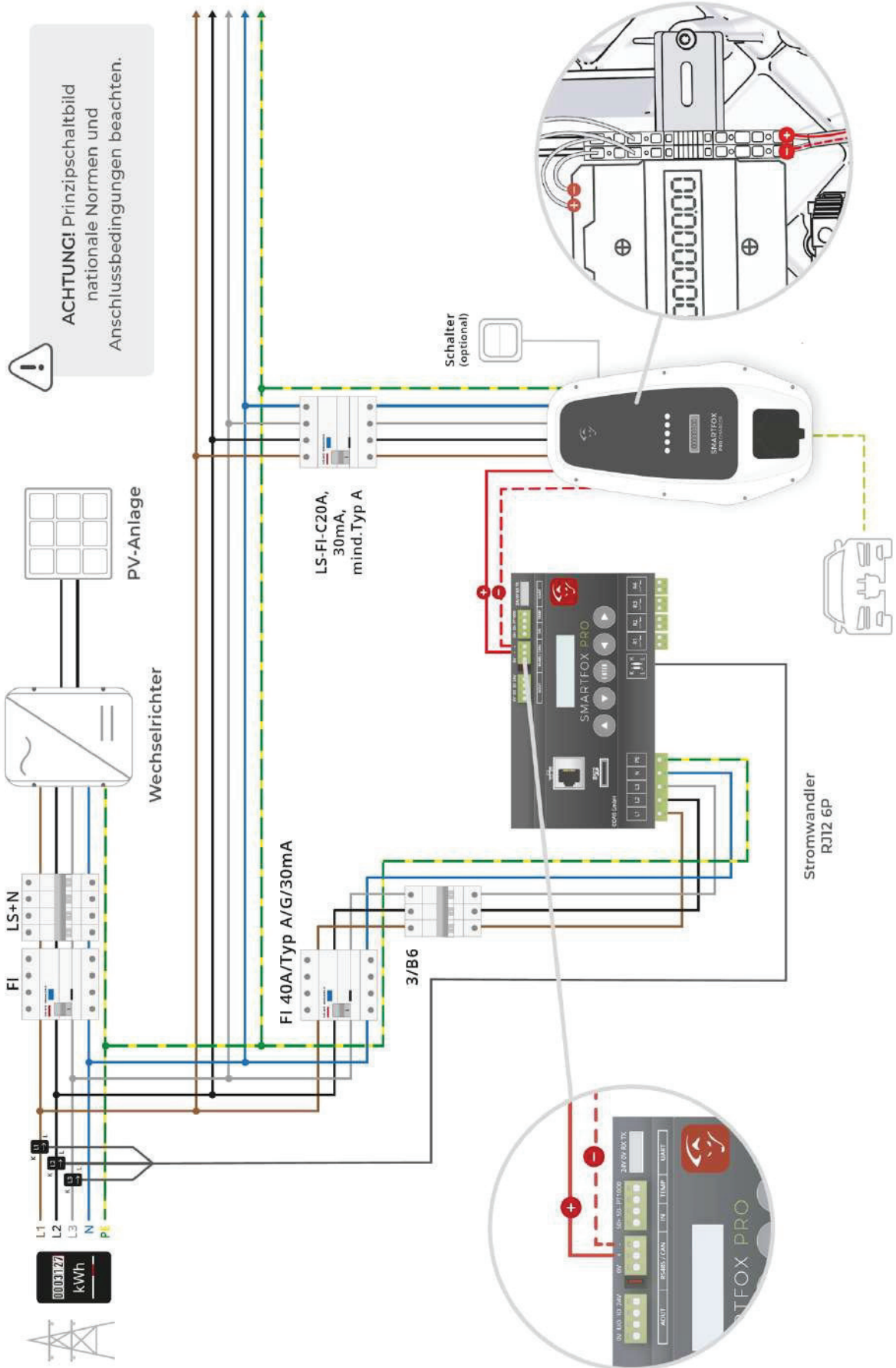

Figure 22 Connection diagram with SF Pro - 1 charging station



7.2 Connection of several charging stations (max. 5)

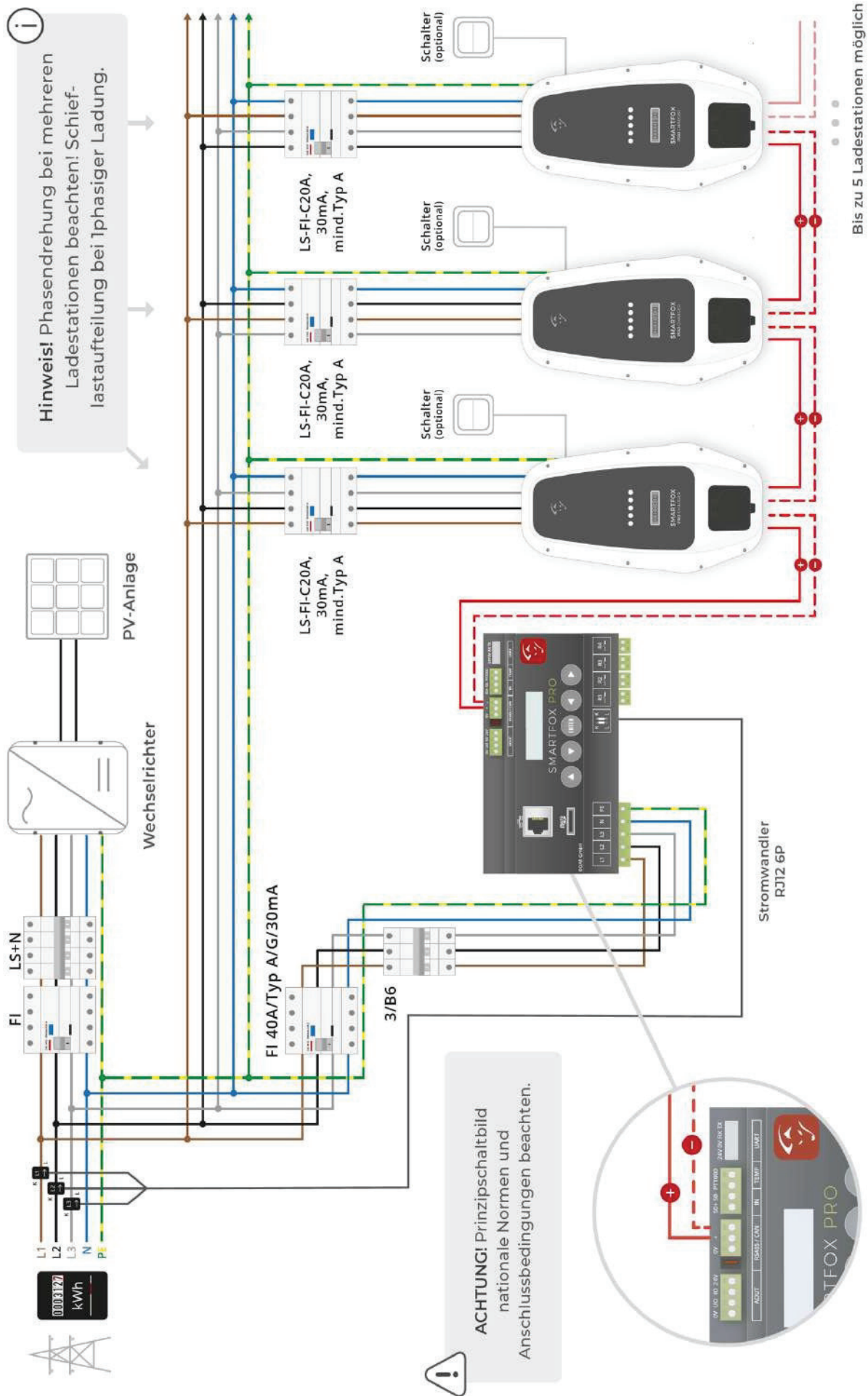

Figure 23 Connection diagram with SF Pro - Multiple charging stations

7.3 Second control level (SMARTFOX Energy Meter) several charging stations

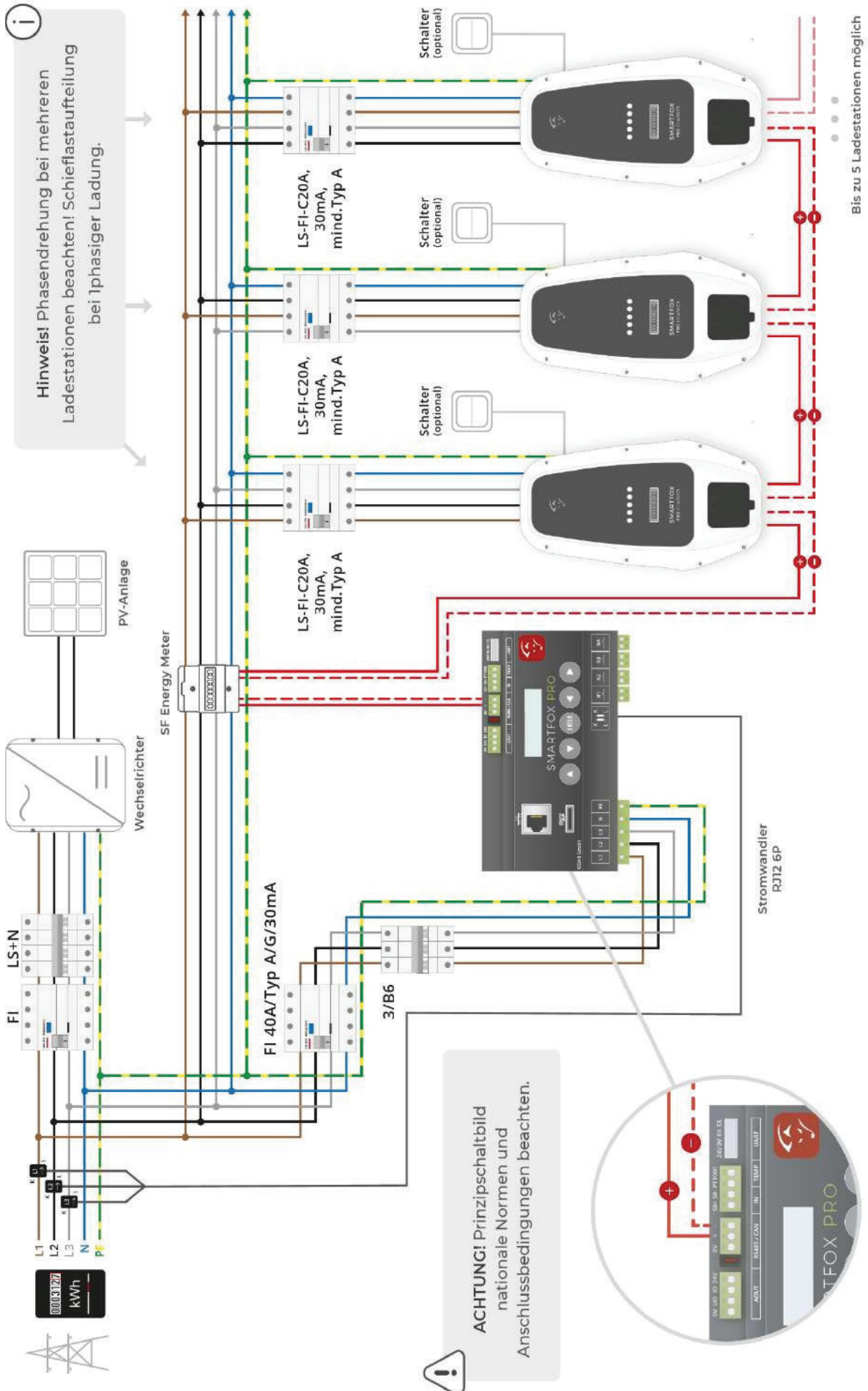

Figure 24 Connection diagram with second control level



7.4 Connection manual switch (optional)

In order to be able to switch the charging mode (automatic (surplus mode) & manual (forced charging)) of the Pro Charger without APP or web portal, it is possible to connect an external manual switch.

To do this, connect the "+12V DC" cable coming from the V+ connection from terminal E1 to E3. Then connect the 12V supply at contact E3 to the E1 terminal via an external switch of your choice (toggle switch, key switch...).



When closed, the charging station is in "Automatic mode" (surplus). If the switch is opened, the charging station switches to "Manual mode" (forced charging). If the switch is open, the status "On-site switch active" is output on the SMARTFOX. The charging mode can no longer be changed via the web interface until the switch is closed again.

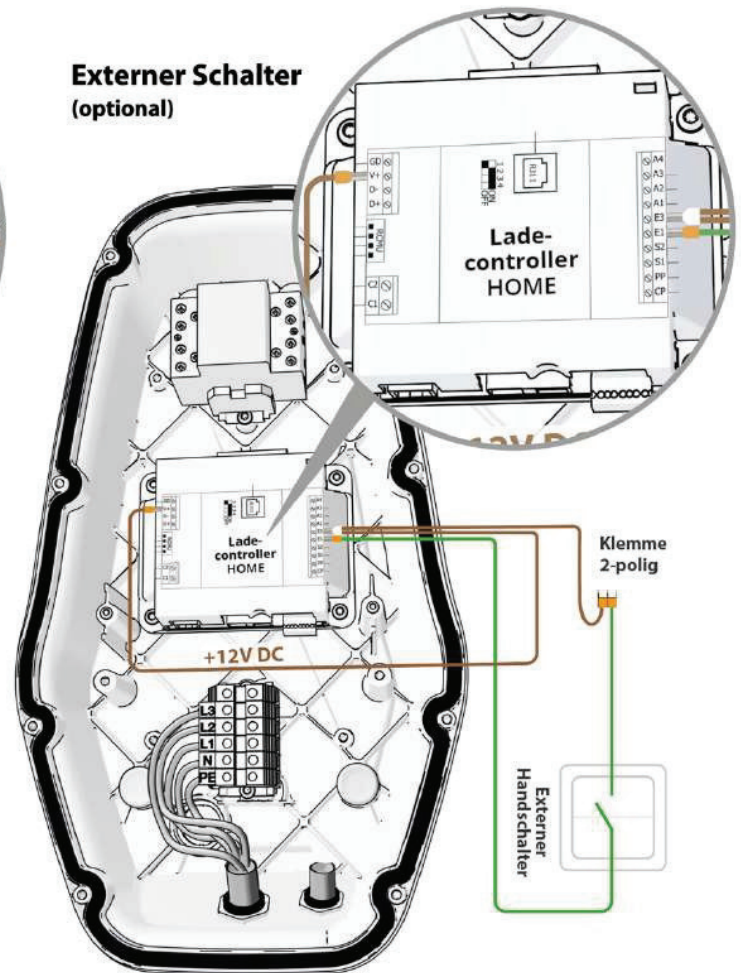
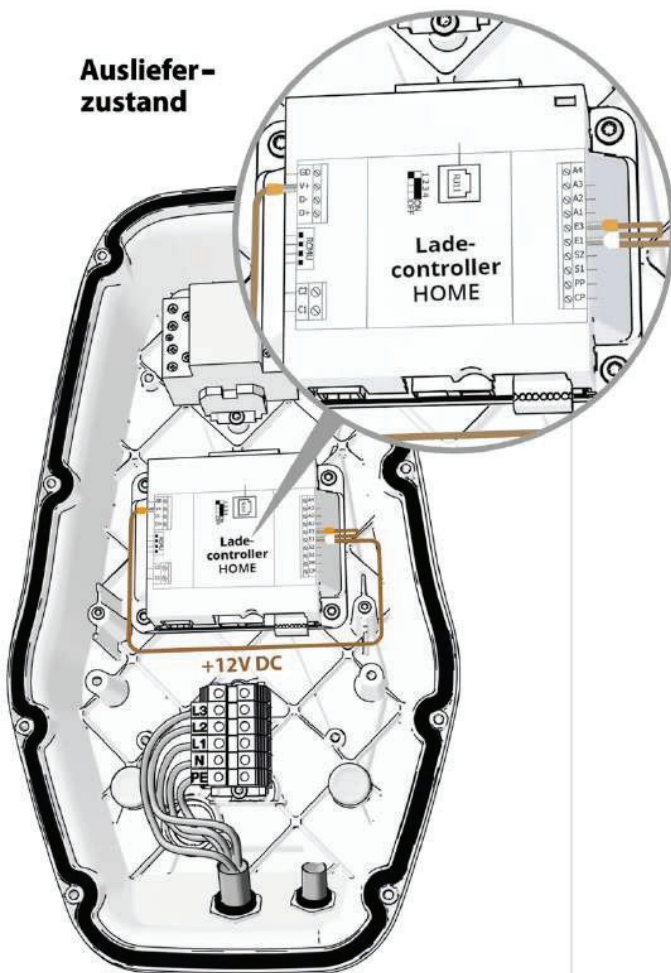

Zu messende Spannung

E1	→	GND	=	+12V DC
E3	→	GND	=	+12V DC

Schalterposition

Schalter geschlossen	Überschussladung
Schalter offen	Zwangsladung
Unabh. v. Schalterposition	---

Zu messende Spannung

E1	→	GND	=	+12V DC
E1	→	GND	=	0V DC
E3	→	GND	=	+12V DC

8 Control via SMARTFOX Pro Energy management

In order to be able to use the full range of functions of the charging station, it can be connected to the SMARTFOX Pro energy management system. This enables surplus-optimised charging, dynamic load management, remote control via APP and many other functions.

8.1 Required Article

» SMARTFOX Pro inkl.
Stromwandler 80A, ArtNr. 0791732486575 oder
Stromwandler 100A, ArtNr. 0791732486698
Softwarestand EM2 00.00.02.01 oder höher



8.2 Registration Web portal my.smartfox.at

- a) Open my.smartfox.at website
- b) Log in with your existing account or click on the button "Register now" to create a new account.

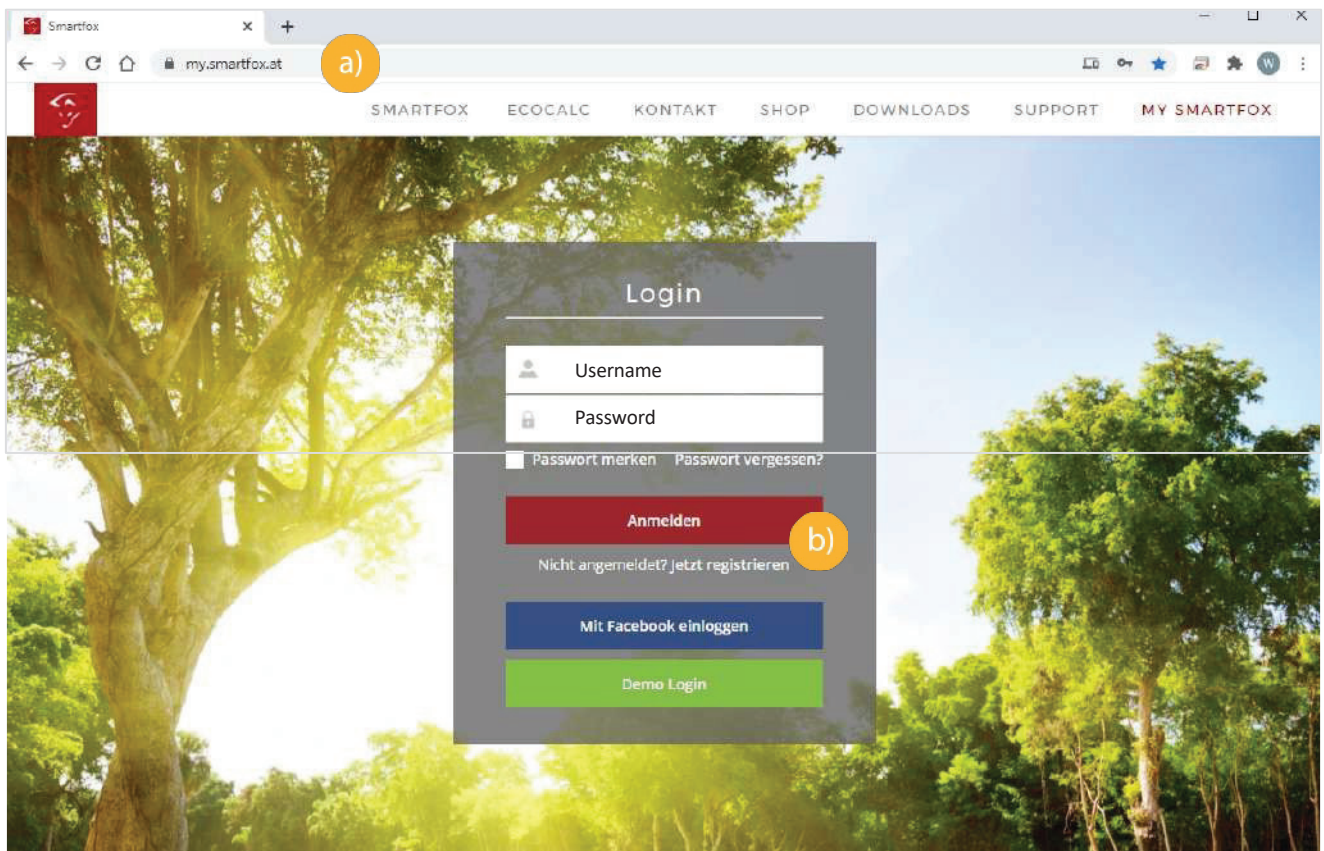



c) Complete the registration data:

SMARTFOX ECOCALC KONTAKT SHOP DOWNLOADS SUPPORT MY SMARTFOX

Registrieren

c)

Firma	<input type="text"/>	Straße/Hausnummer	<input type="text"/>
Vorname	<input type="text"/>	Adresszusatz	<input type="text"/>
Nachname	<input type="text"/>	PLZ	<input type="text"/>
E-Mail-Adresse	<input type="text"/>	Ort	<input type="text"/>
Benutzername	<input type="text"/>	Land	<input type="text" value="Austria"/>
Passwort	<input type="password"/>	Währung	<input type="text" value="Euro"/>
Passwort bestätigen	<input type="password"/>	Capcha	<input checked="" type="checkbox"/> Ich bin kein Roboter
Telefonnummer	<input type="text"/>		
Sprache	<input type="text" value="Deutsch"/>		

Registrieren

Fernwartung

d) You will receive an email with the registration link. Confirm this.



The login to my.smartfox.at is now available.



8.3 Add SMARTFOX Pro

a) The SMARTFOX Pro can be created by clicking on the green plus "Add device".

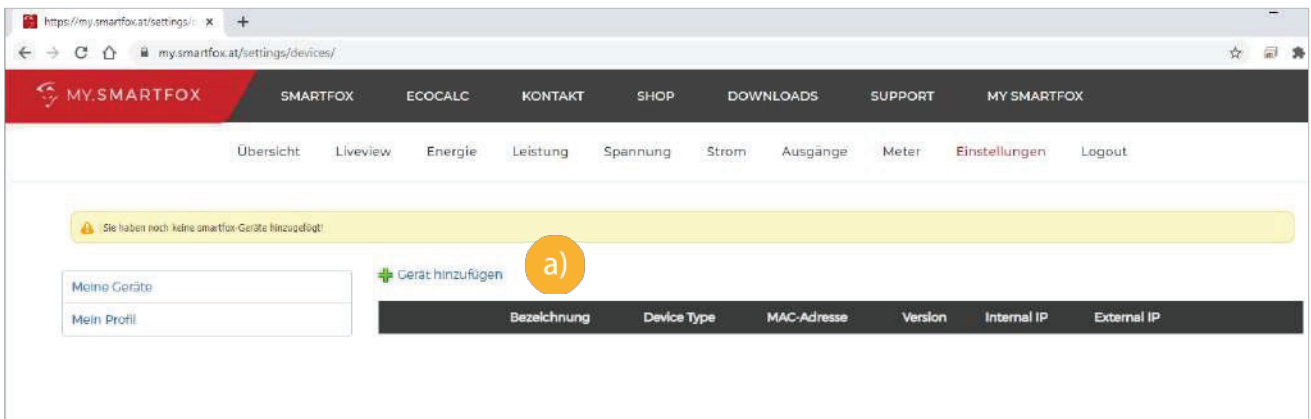

b) The designation of the unit can be freely selected

c) Enter the 12-digit MAC address of the SMARTFOX Pro. The MAC address can be read on the type plate (unit, packaging), in the main display menu of the unit or copied from the local web server (<http://dafi-smartfox>). The MAC address must be entered in capital letters without separators.

Ex: D88039AD5198



d) Select the "smartfox" device group.

e) Set the tick marks as required by the functions (can be adjusted later at any time).

f) Click on "Save".

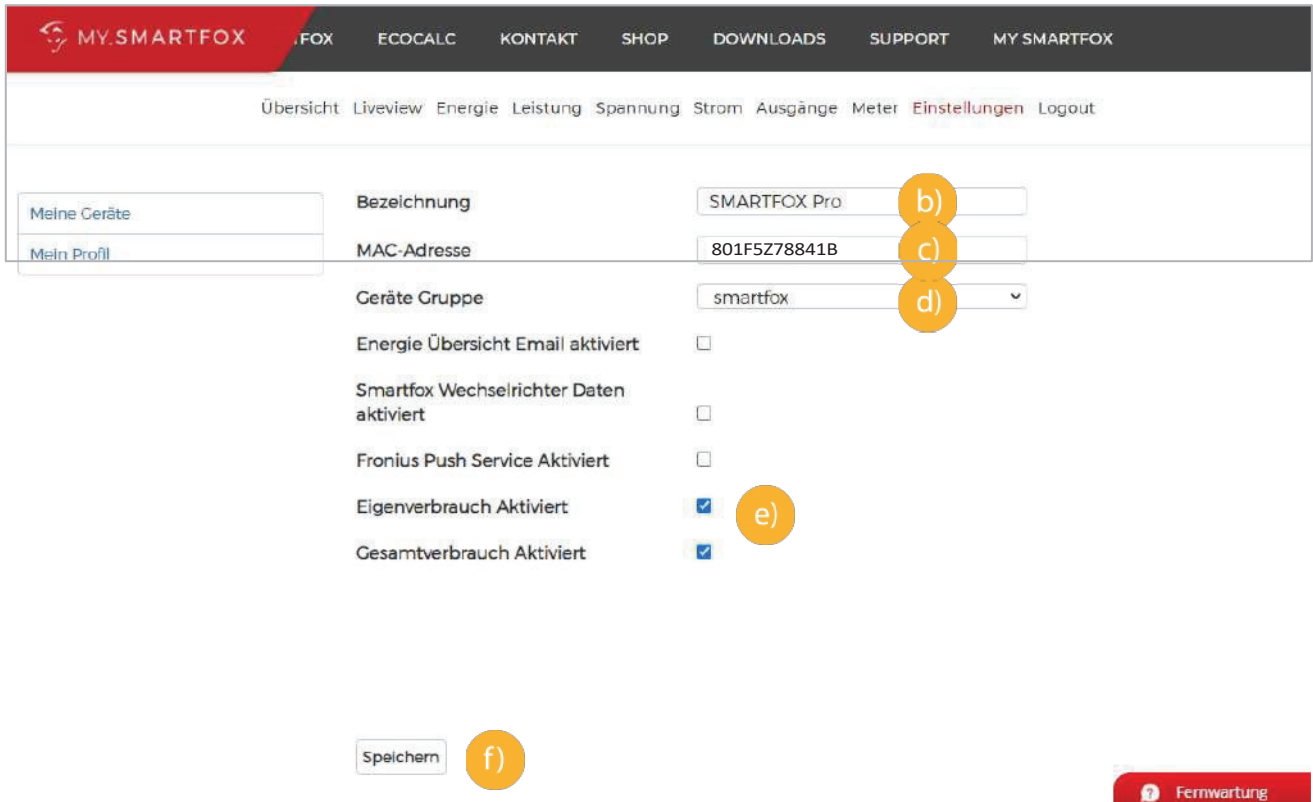

g) The device appears in the overview under "Settings" > "My devices"

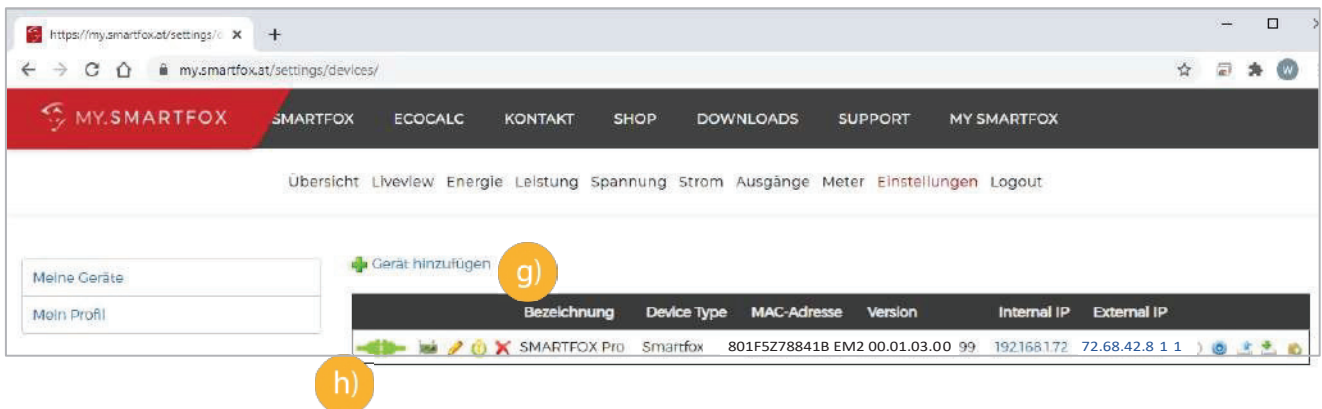

h) If the plug symbol is green and connected, the SMARTFOX can be accessed via the web portal and parameterisation can be started.



If the plug symbol remains red and disconnected, restart the SMARTFOX or check the network connection and network settings.



8.4 Software / Software update

- a) The minimum software version **EM2 00.01.03.00** is required to integrate the charging station.

If an older version is installed, carry out a software update. The update can be carried out in the menu item "Software update". To do this, follow the instructions in the menu.

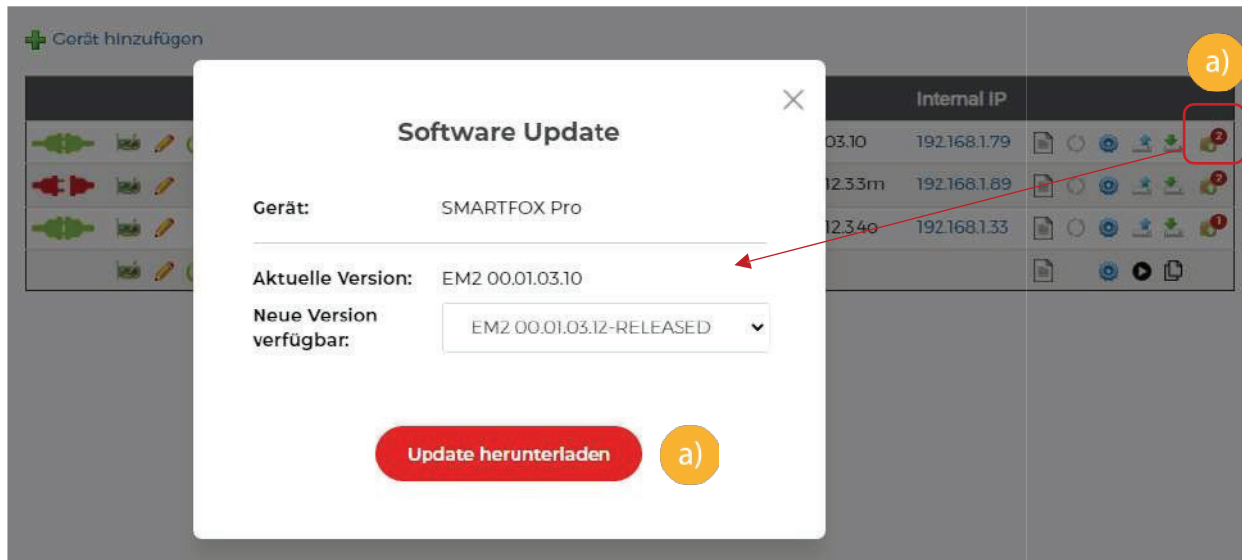

- b) If version **EM2 00.00.02.01** is already installed on the SMARTFOX Pro and the device is connected to the Internet, the update can also be carried out directly on the device by holding down a key combination.

To do this, hold the outer two buttons (arrow up + arrow right) simultaneously for approx. 10s.

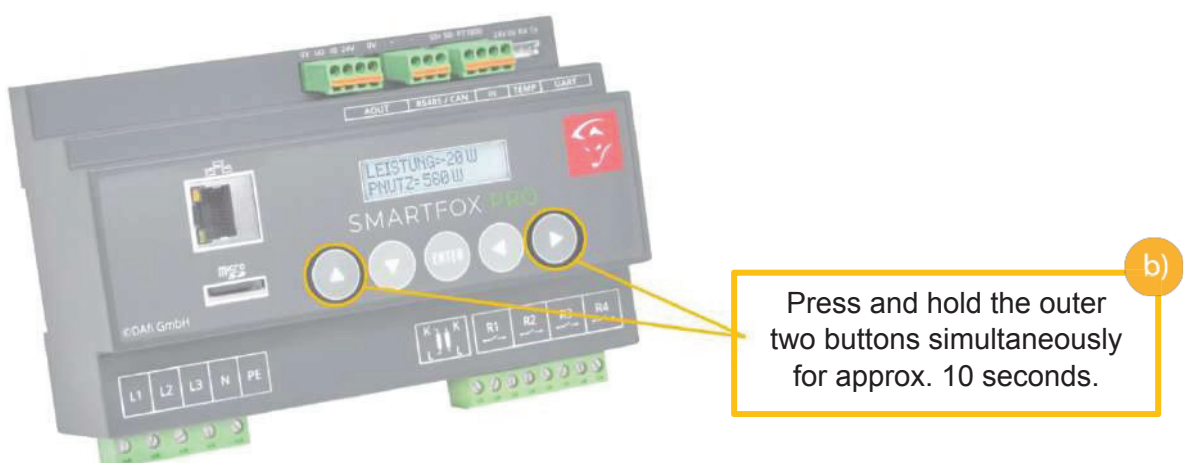

- c) Further options and details on software updates can be found in the SMARTFOX Pro operating instructions or at www.smartfox.at/downloads.



8.5 Add licence / serial number

a) Open licence menu

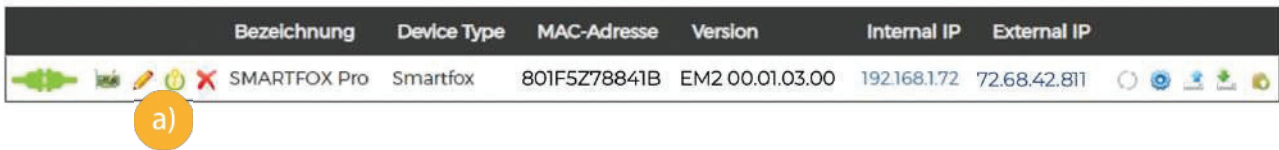

b) Enter the serial number (see type plate on charging station / packaging) of the SMARTFOX Pro Charger.

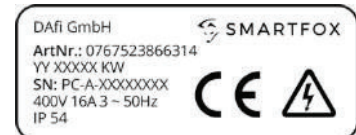

c) Click on "Save".

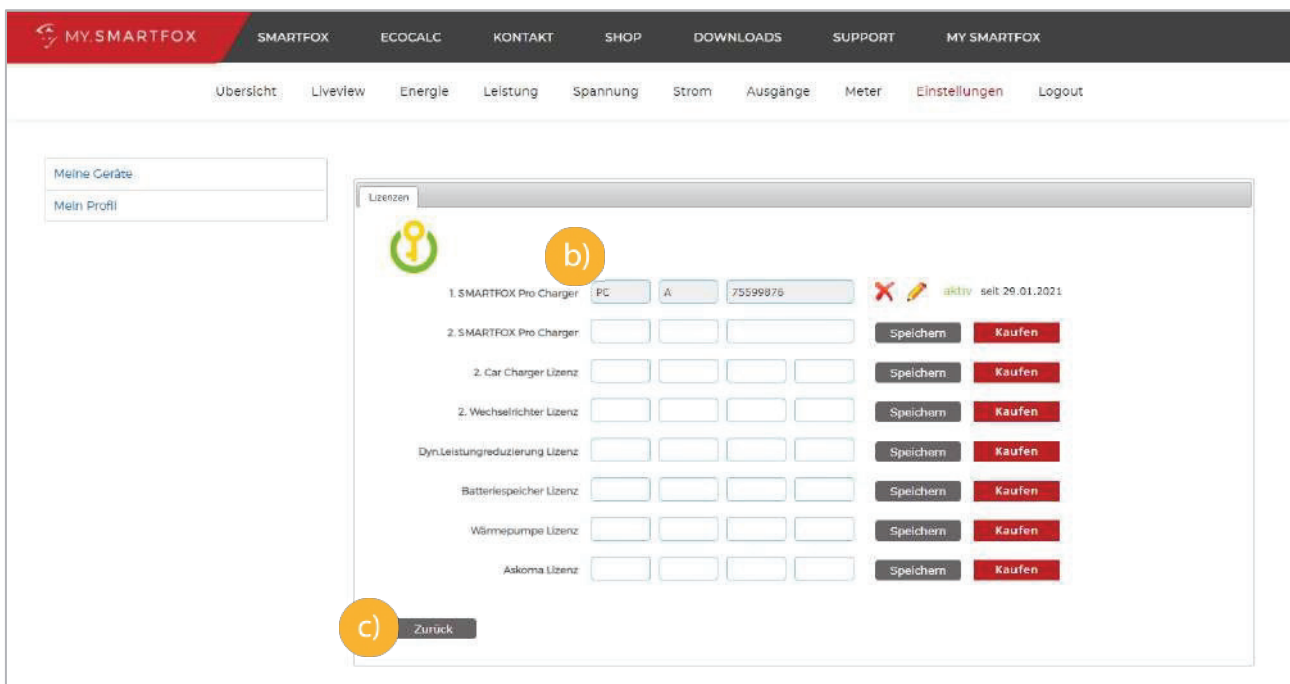

Up to 5 SMARTFOX Pro Chargers can be added. After activating a charging station, the next input field appears.

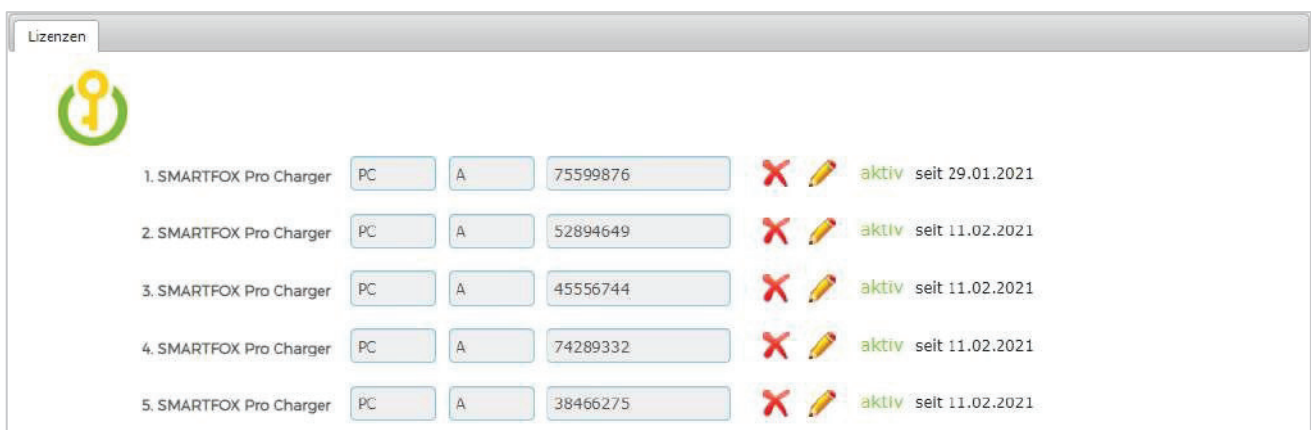



8.6 Parameterisation SMARTFOX Pro

The following steps show the parameterisation via the web portal my.smartfox.at, all settings can also be carried out directly on the device or via the IP address (local) or the WIFI access point of the SMARTFOX.

a) Open the "Unit parameterisation" by clicking on the cogwheel symbol.

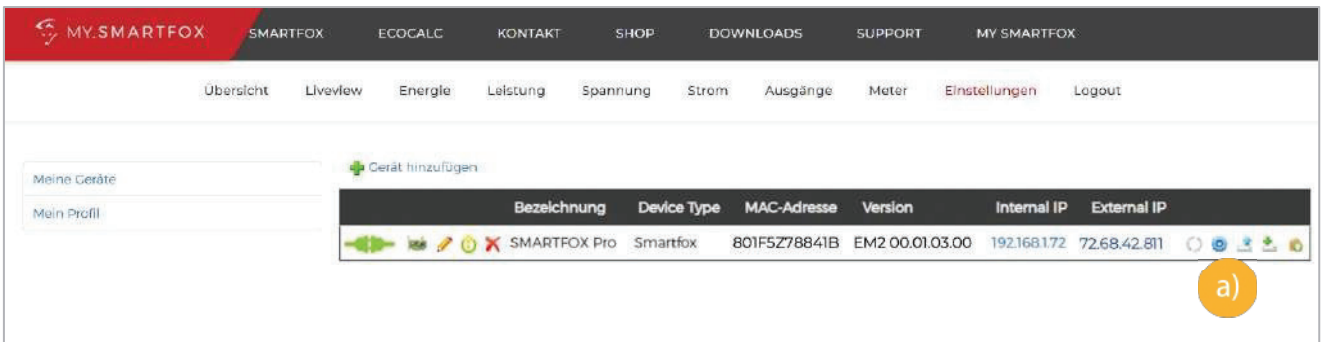

b) Under "Settings", select the "Charging station" menu.

c) Select a free field by clicking on it.

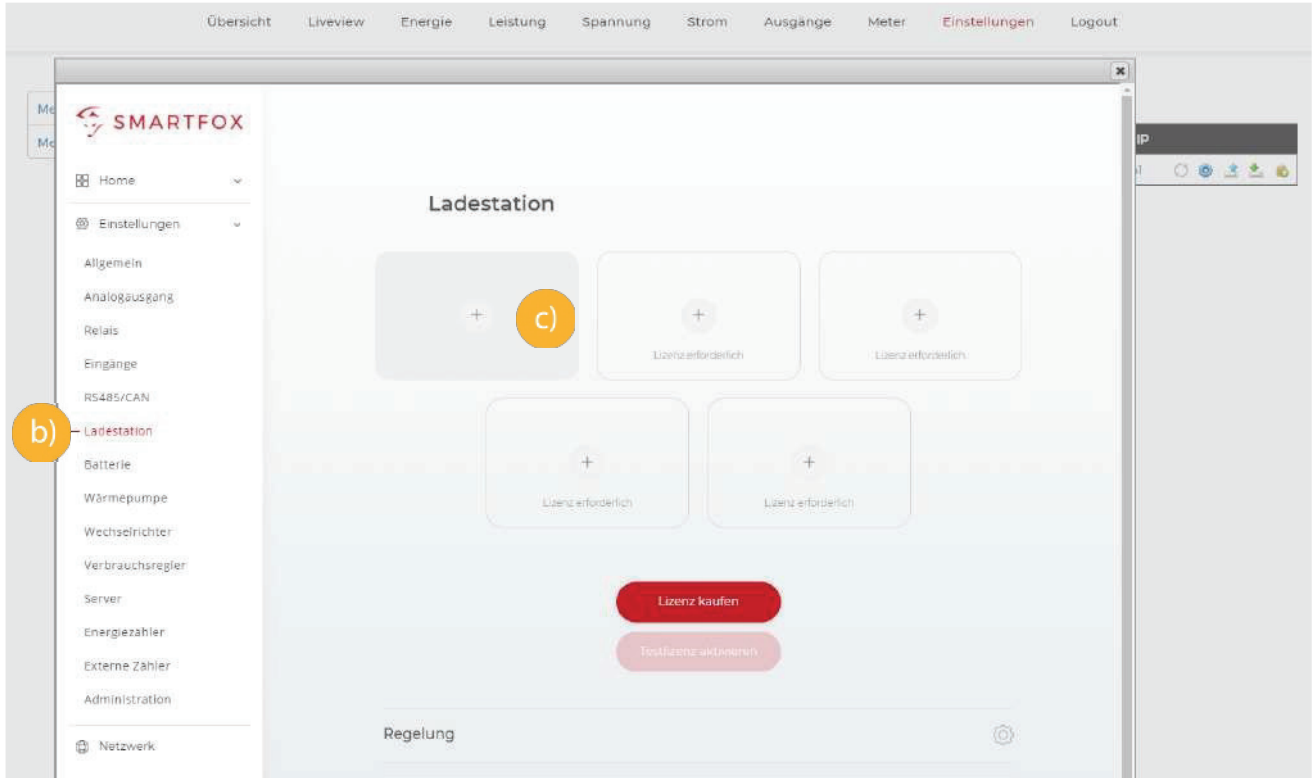



d) The pop-up window opens

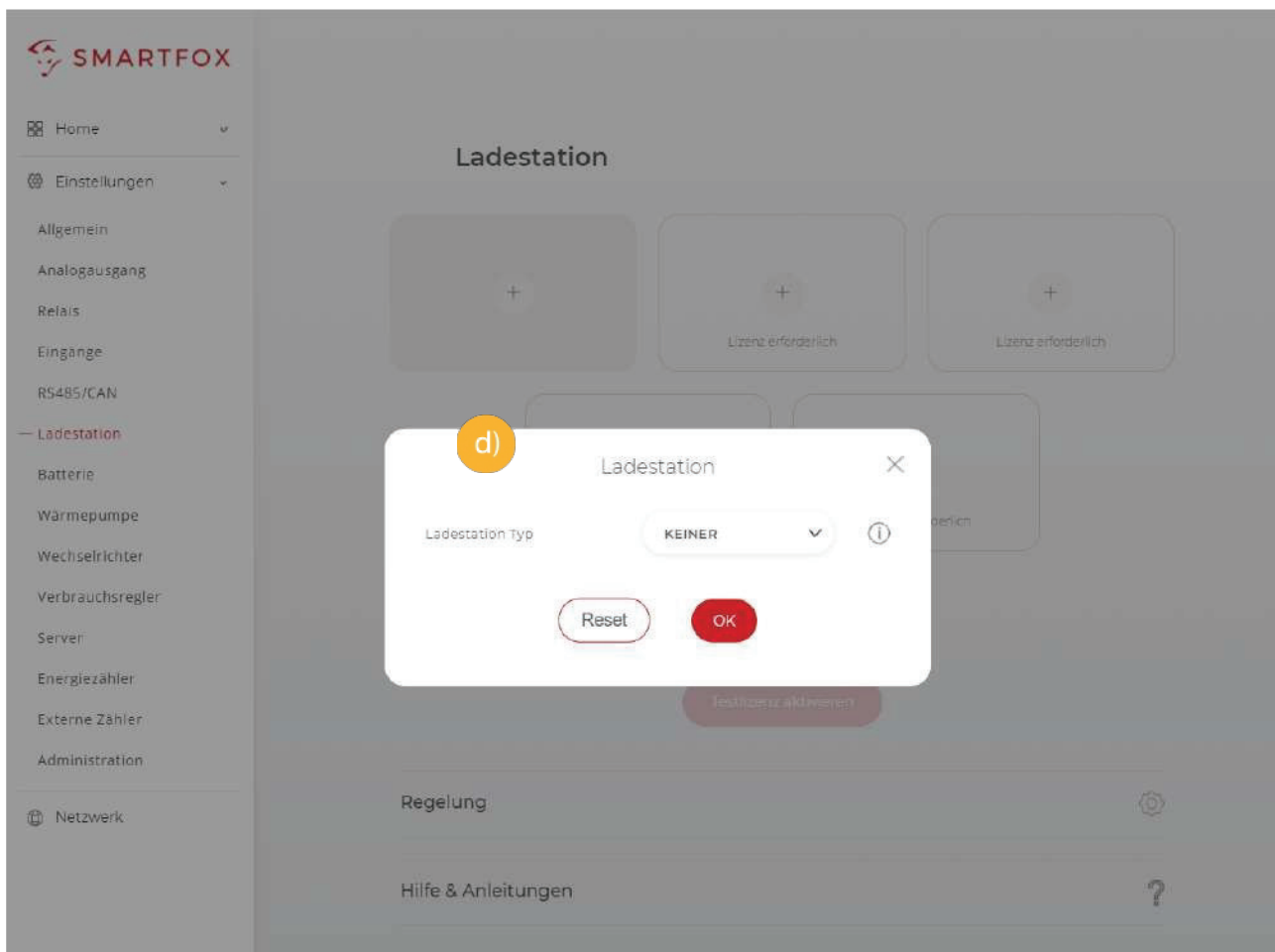

e) Select "SMARTFOX Pro Charger" in the drop-down menu.

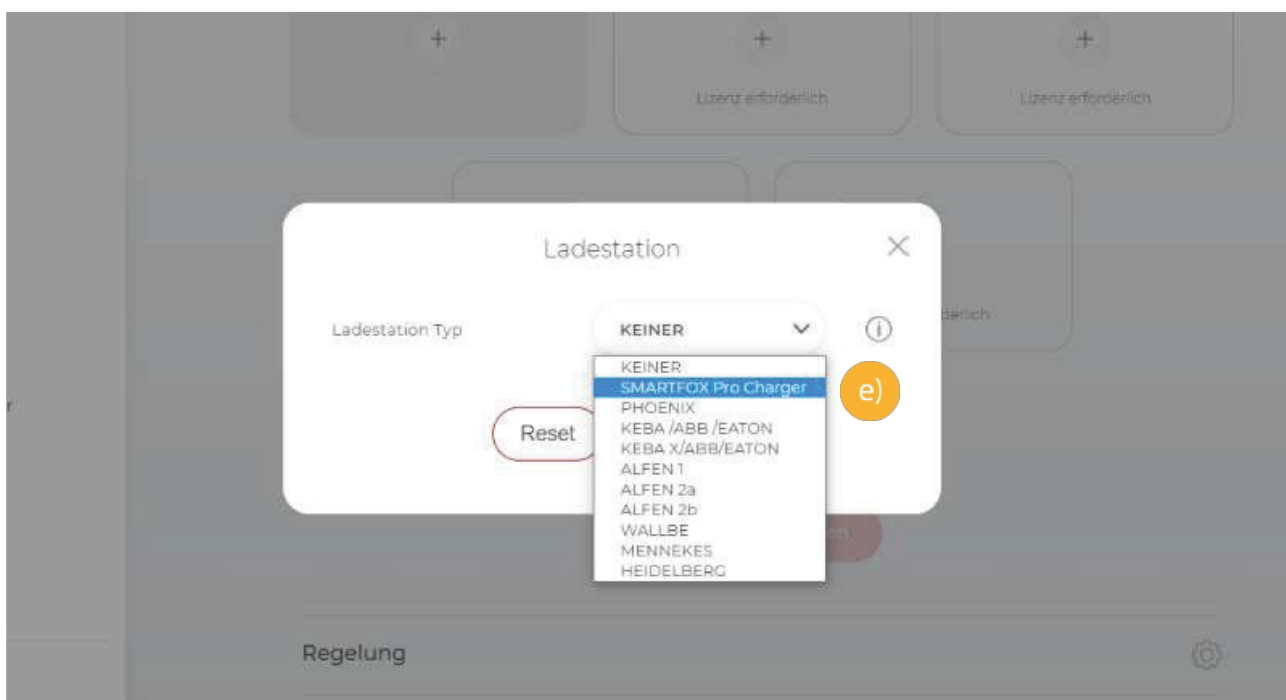



- f) The commissioning wizard is called up.
- g) Click on "Start configuration"

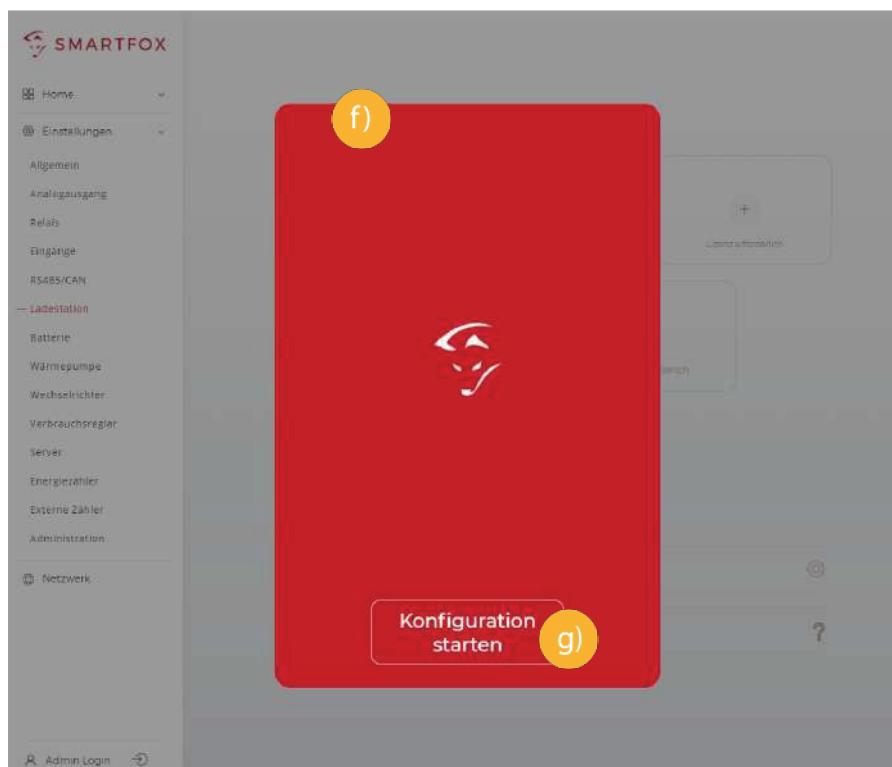

- h) Make sure that only the charger to be configured is switched on!
- i) Click on "Configure"

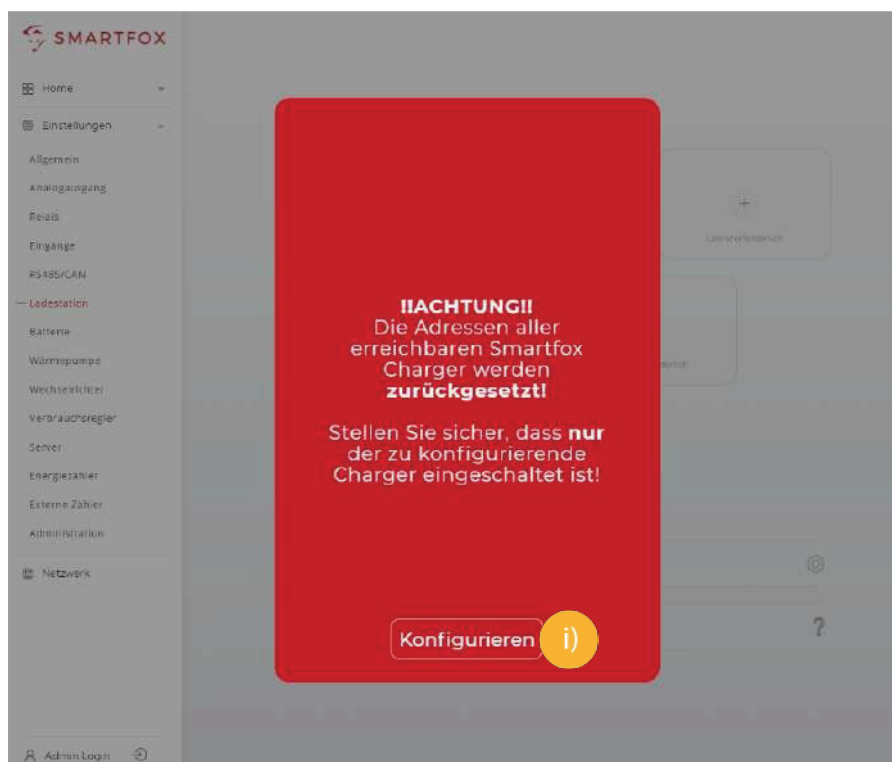



j) The system starts the configuration.

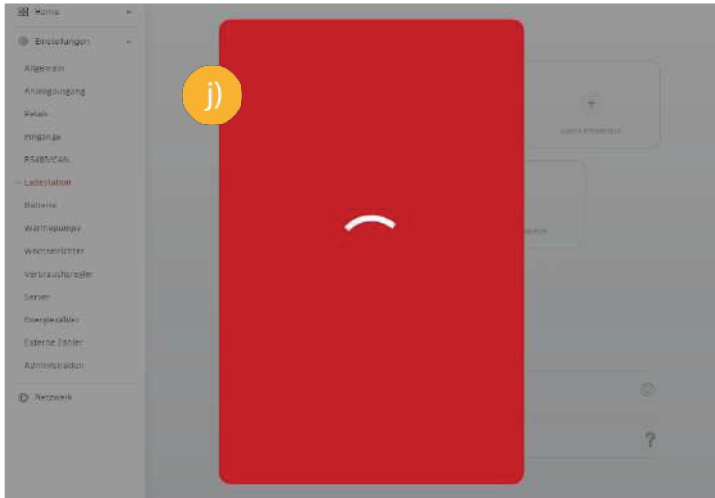

k) If the LEDs on the charger flash alternately blue / green, the configuration was successful.

l) Click on "Done"

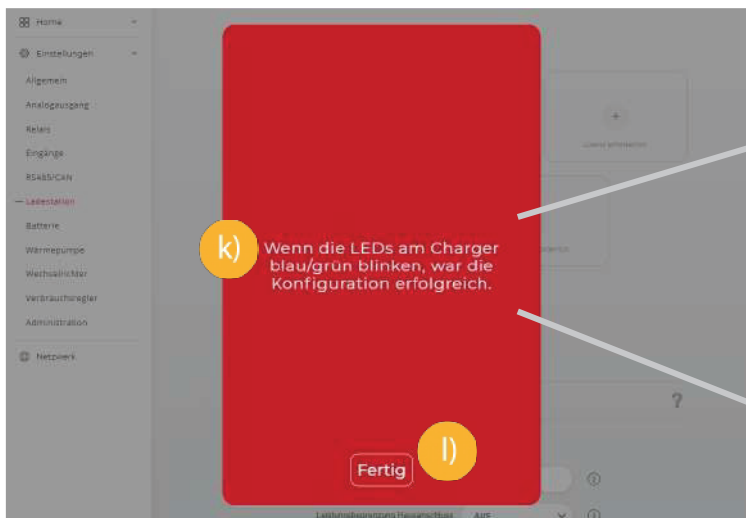

After configuration, "SMARTFOX devices" should automatically appear in the menu under RS485/CAN. Adjust the settings if necessary.

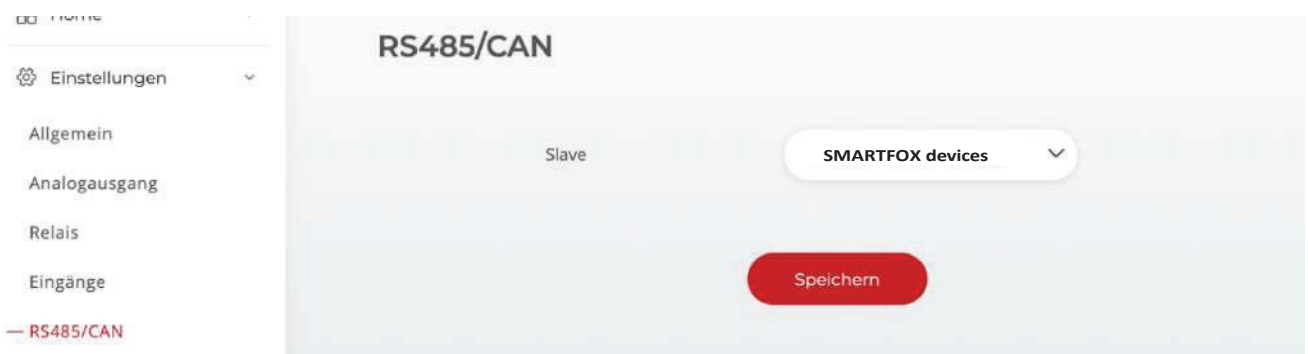



8.7 Further Parameterisation

- If the configuration was successful, further parameterisation can be started.
- Assign a name with which the charging station is to be displayed in the overview. e.g. Garage
- Assign colour with which the charging curve is displayed in the charts (power, energy...)
- Enter the maximum charging current of the charging point (charging station fuse) in amperes. $16A / 3\sim = 11kW$
- Assign priority to the charging point (priority with only 1 charging station without function). Multiple charging stations: **1 = highest priority 5 = lowest priority**
Charging stations with the **same priority** are controlled in **parallel**.
- Control: The "Control Mode" indicates whether the charging station regulates up or down.
Standard = It is regulated up from the minimum charging power to the setpoint (recommended).
Up-Down= It is regulated down from the maximum charging power to the setpoint.
- Activate automatic phase switching or set the charging station to 1-phase or 3-phase operation.
- Keypad: Activates the functions of the external keypad (5 keys + RFID option).
- M+ mode: Activates the M+ charging mode. A defined energy or time can be set. The fallback mode specifies the charging mode that is activated after the M+ function has expired.

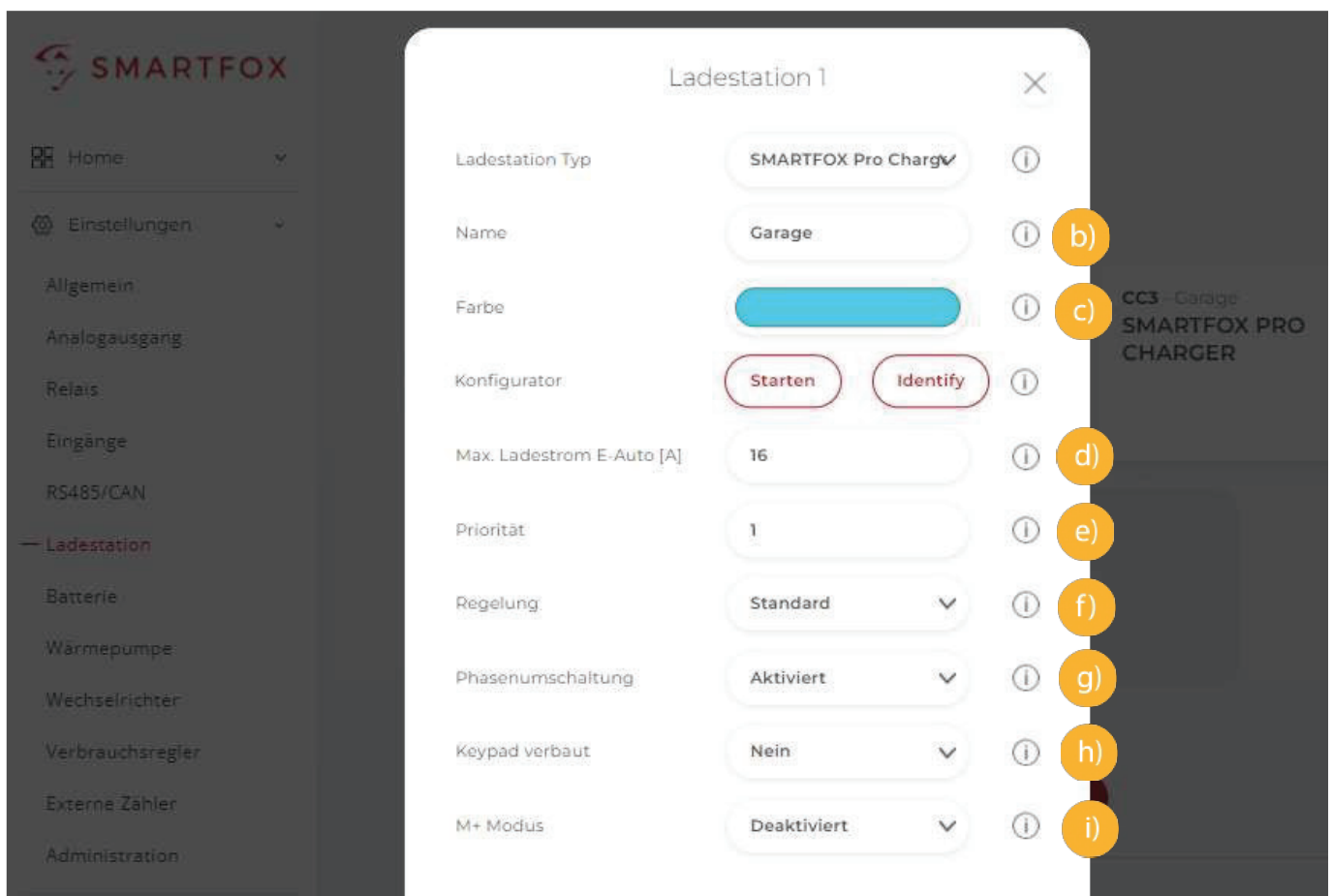



- j) The charging station is displayed in the overview.
- k) At the bottom right you can see the connection status of the respective charging station.

Green tick: Communication successful

Red X: Communication error

- l) Under "Regulation", the fine setup of the charging stations can be carried out.

The screenshot displays the SMARTFOX web interface. On the left is a navigation menu with options: Home, Einstellungen (Allgemein, Analogausgang, Relais, Eingänge, RS485/CAN), Ladestation (Batterie, Wärmepumpe, Wechselrichter, Verbrauchsregler, Administration), and Netzwerk. The main content area is titled 'Ladestation' and shows a grid of charging station cards. The first card, labeled 'CC1 - Garage SMARTFOX PRO CHARGER', has a green checkmark in the bottom right corner, indicating successful communication. Below this is a 'Hilfe & Anleitungen' section with a question mark icon. The 'Regelung' (Regulation) section contains several adjustable parameters:

Parameter	Value	Info Icon
Regelzeit [s]	3	ⓘ
Leistungsbegrenzung Hausanschluss	EIN	ⓘ
Netzbezug max. Leistung [kW]	30	ⓘ
Einschaltverzögerung [min]	1	ⓘ
Ausschaltverzögerung [min]	1	ⓘ
Zielwert [W]	0	ⓘ
Leistungs Offset [W]	0	ⓘ
Analogausgang Aktiv	EIN	ⓘ

At the bottom right of the settings area is a red 'Speichern' (Save) button. The bottom left corner shows 'Admin Login' and a refresh icon.



The screenshot shows the 'Regelung' (Control) settings page. It contains the following items:

- Regelzeit [s]**: Input field with value '3', icon 'm)
- Leistungsbegrenzung Hausanschluss**: Dropdown menu with value 'EIN', icon 'n)
- Netzbezug max. Leistung [kW]**: Input field with value '30', icon 'o)
- Einschaltverzögerung [min]**: Input field with value '1', icon 'p)
- Ausschaltverzögerung [min]**: Input field with value '1', icon 'q)
- Zielwert [W]**: Input field with value '0', icon 'r)
- Leistungs Offset [W]**: Input field with value '0', icon 's)
- Analogausgang Aktiv**: Dropdown menu with value 'EIN', icon 't)

At the bottom, there is a red 'Speichern' (Save) button and a yellow 'u)' button.

m) **Control time:** The time in which the control carries out value changes. The minimum possible control time for a charging point is 3s. For each additional active charging point, the control time must be increased by 1s. e.g. 5 charging points $n=5$; $3s + n - 1 = 3s + 5 - 1 = 7s$

1 Charge point = 3s	points = 4s	points = 4 Charge
points = 6s	7s	

n) **Power limit house connection:** Here you can set whether the power of the house connection should be taken into account when charging the vehicle. If a forced charge is carried out and further consumers (e.g. electric cooker) are switched on in the house and thus the limit of the house connection fuse is reached, SMARTFOX Pro dynamically regulates the charging station back.

o) **Mains supply max. power:** If the setting "Power limitation house connection" is activated, the maximum power of the house connection must be entered here. The value can be entered between 0 - 5000 kW.

p) **Switch-on delay:** The "Switch-on delay" causes a certain time to be waited until the charging station releases a charge, despite sufficient surplus. A delay of 0 - 255 minutes can be set. The setting prevents too frequent switching on or off in case of changing surplus conditions.



- q) **Switch-off delay:** If the surplus collapses for a short time during the charging process (e.g. in clouds), the selected time of the "switch-off delay" is waited for before the charging is terminated. This allows short periods of draw during charging to be bridged. A delay of 0 - 255 minutes can be set. The setting thus prevents too frequent switching on or off during changing surplus conditions.
- r) **Target value:** The "target value" can be set between -30000W & +30000W. In order not to draw energy from the mains, 0W or a negative value should be set here (e.g. -200W).
- s) **Power offset:** Additional power that is used for the switch-on threshold. The value is to be left at "zero" by default and is only required in special cases when the minimum switch-on power of the vehicle to be charged deviates from the standard. The value can be set between - 30000W & +30000W.
- t) **Aout active:** Indicates whether the analogue output should be activated while the vehicle is being charged or not. Ex. ON: The analogue output is activated while the vehicle is being charged.
- u) Click on "Save".



Wurden alle erforderlichen Einstellungen getätigt, ist die Ladestation nun betriebsbereit und im LiveView ersichtlich (siehe Bild unterhalb).

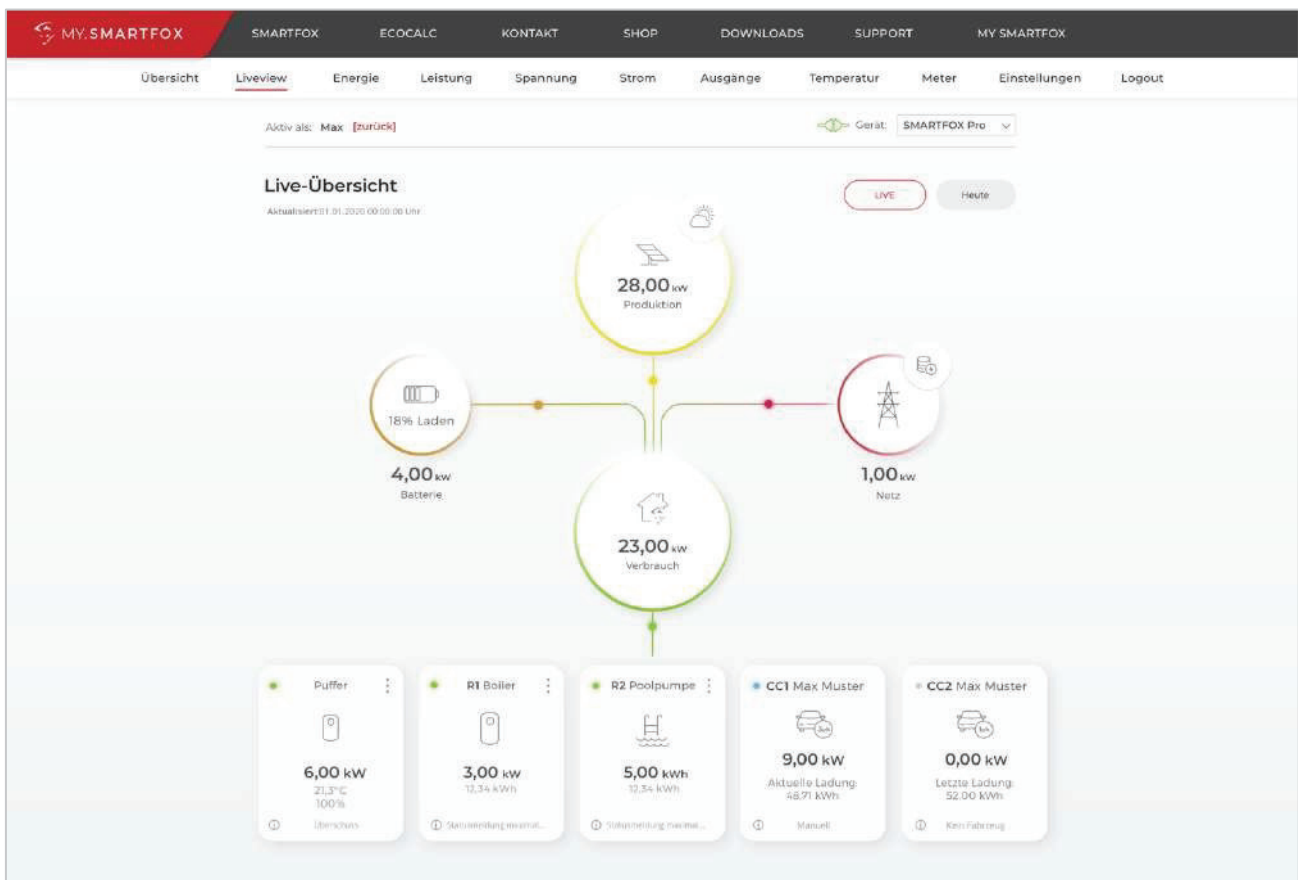



8.8 Live overview

- The parameterised charging station is displayed in the overview with the assigned name.
- The mini LEDs in the upper left area of the tile visualise the activity of the consumer.

Entire symbol greyed out: Charging station is deactivated

● **LED grey:** Load temporarily switched off

● **LED green:** Consumer is operated with surplus energy

● **LED blue:** Load active. The load is operated with PV surplus, if the surplus energy is not sufficient, additional electricity is drawn from the grid.

- The **icon / symbol** shows whether the charging station is in 1-phase or 3-phase mode.
- The current charging power** can be read off under the icon. As well as the **energy** already absorbed during **the current charging process or the last charge**.
- The **status info** shows the current message of the charging station in an abbreviated form. Click on the tile to display the complete status message.



The following short messages are possible:

- | | |
|--------------|------------------|
| - No vehicle | - Switching time |
| - Surplus | - Energy tariff |
| - No surplus | -Car Charge Stop |
| - Manual | -No release |
| - Switching | -not connected |
| - Switch On | - Error |

- Complete status messages (see figure next page)

Status

- | | |
|--------------------------------|-------------------------------------|
| - Waits for sufficient surplus | -No vehicle |
| - Switching time is active | -Not ready |
| - Manually switched on | - Ready |
| - Switched on Energy tariff | -It is charging |
| - Loads with surplus | - Error |
| - Phase switching | -Not authorised / temperature error |
| - On-site switch on | -Car Charge Stop (EVU lock) |
| - Connection error RS485 | |

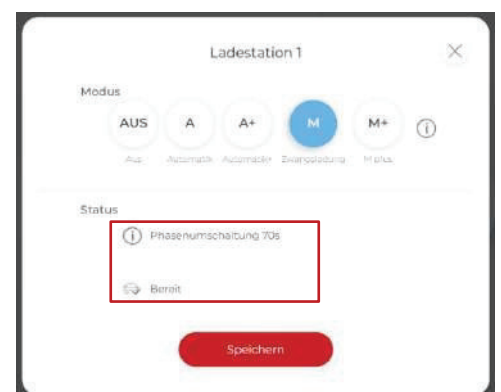



Clicking on the symbol opens the pop-up window for selecting the charging mode:

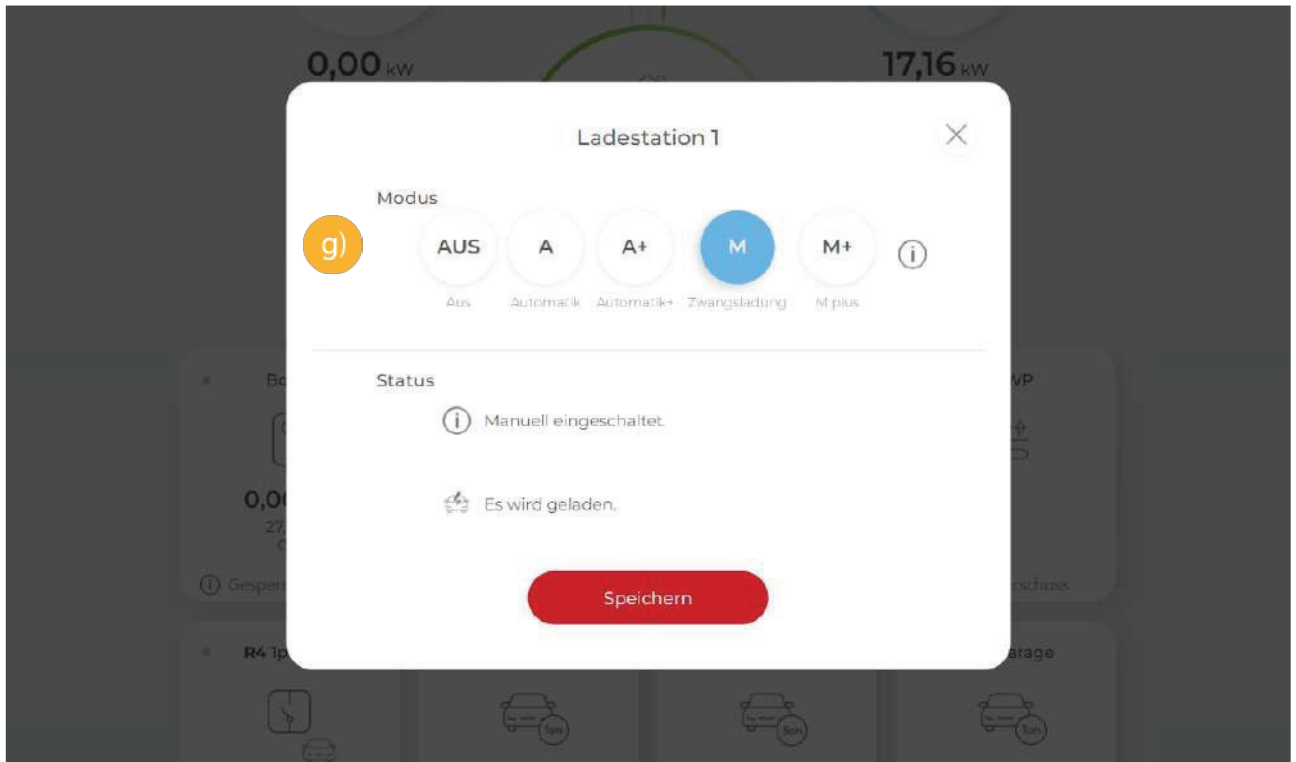

g) Modes

Mode OFF (Switched off)

The charging station is locked and does not release a charge.

Mode M (forced charging):

The vehicle is charged with the highest possible charging power (electricity can be drawn from the grid).

Mode A (surplus):

The vehicle is only charged with surplus energy from the photovoltaic system.

Mode A+ (Surplus-Plus)

The vehicle is charged with surplus energy from the photovoltaic system; in addition, the parameterised switching times of the weekly time switch are active.

Mode M+ (Manual Plus)

The vehicle is charged with the defined energy / time. After the target is reached, the system switches to the set fallback mode.



8.9 Parameterisation Weekly timer

In the following section, the parameterisation of the integrated weekly time switch is explained using two examples (1. ready to leave on weekdays; 2. outside opening hours). Up to 3 different switching times can be stored at each output. In this way, automated charging during the night hours (tariff-optimised, load distribution...) can be set and a desired blocking time can be stored.

8.9.1 Example: Integration of switching times "Ready for departure on weekdays ":

If it is not possible to charge by surplus on weekdays (vehicle only at home in the evening or bad weather), the vehicle must of course still remain ready to leave. To ensure this, forced charging of the weekly timer can be triggered in mode A+ (surplus-plus). The following example shows the parameterisation of a mains recharge to ensure a certain minimum charge during the working week.

a) Open unit parameterisation (gear wheel)



a)

b) Under "Settings" select menu "Charging station"

c) Select the appropriate charging station

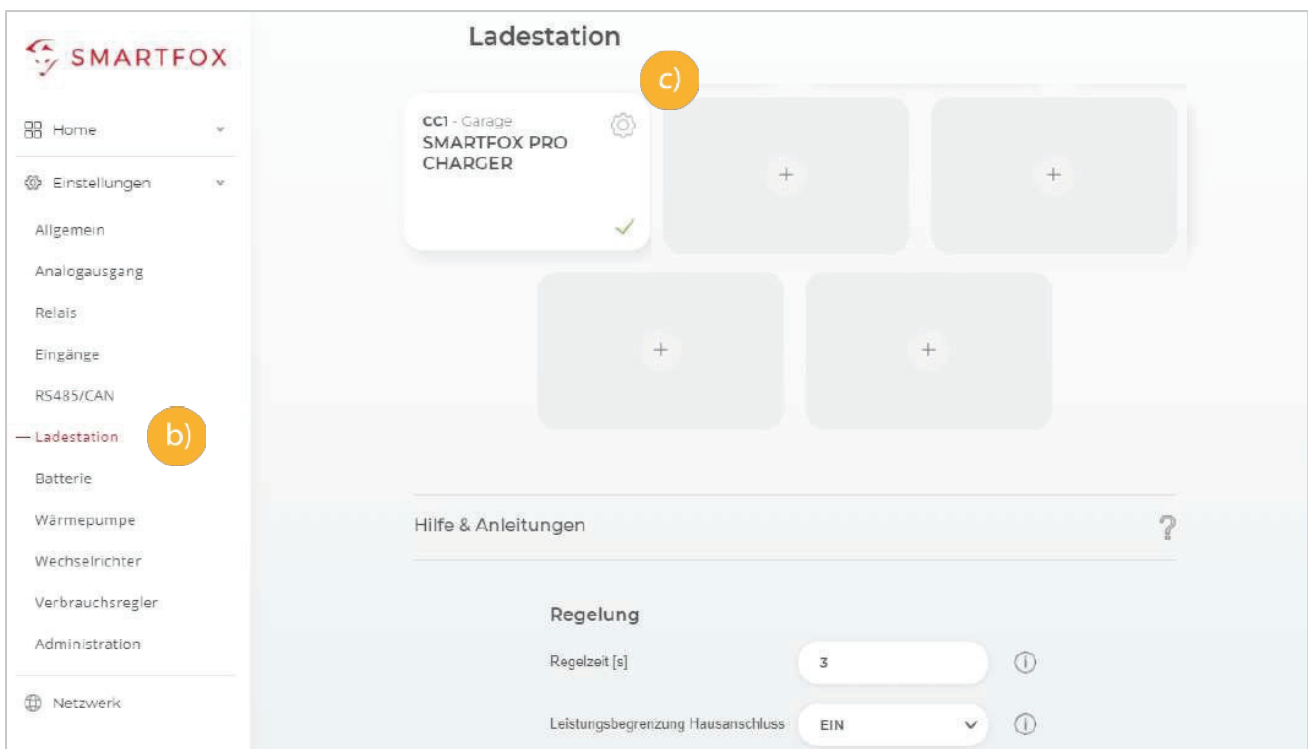



- d) Open one of the three switching times by clicking.
- e) e.g. open switching time 1 by clicking on the plus symbol

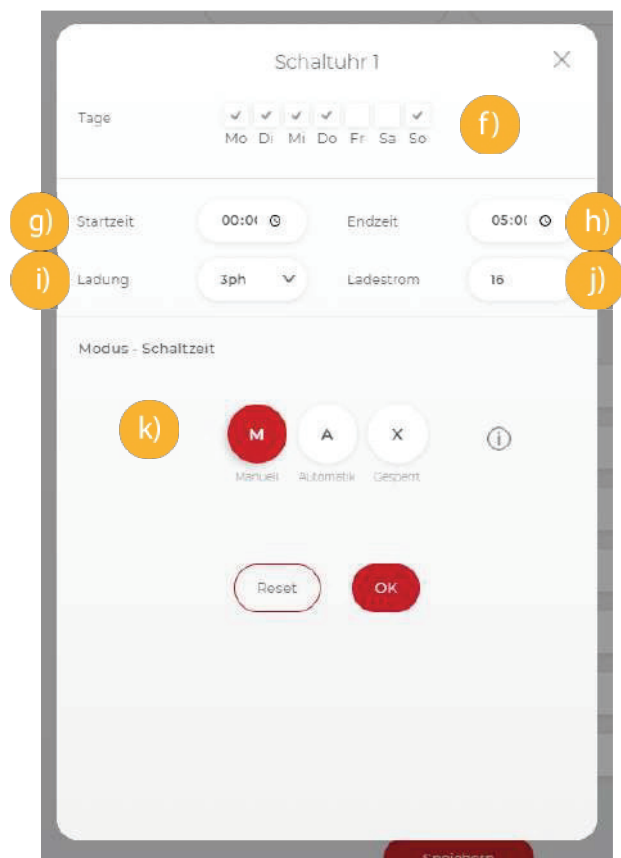
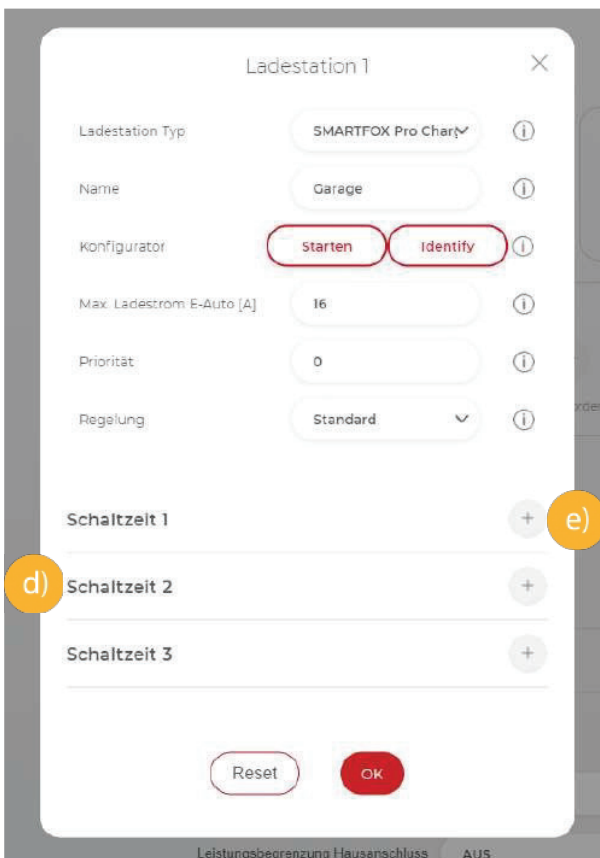

- f) **Days:** Activate desired weekdays of the switching time
- g) Select start time of forced release e.g. 00:00
- h) Set end time of release e.g. 05:00

Recharging is thus active for 5 hours. If several switch-on times are required, up to 3 switching times can be stored.



2 switching times are required for release over midnight.
e.g. switching time 1: start time 22:00 - end time 23:59
Switching time 2: Start time 00:00 - End time 05:00

- i) If the automatic "1ph/3ph switching" is active, the desired charging mode can be set here.
- j) Set the charging current of the recharge e.g. 16A
- k) **"Mode"** specifies whether the time already run in surplus operation beforehand is to be deducted or not (Automatic = time is deducted; Manual = time is not deducted). The counter of the remaining running time is reset to 0 at 06:00 in the morning (remaining running time).



A+ Automatik

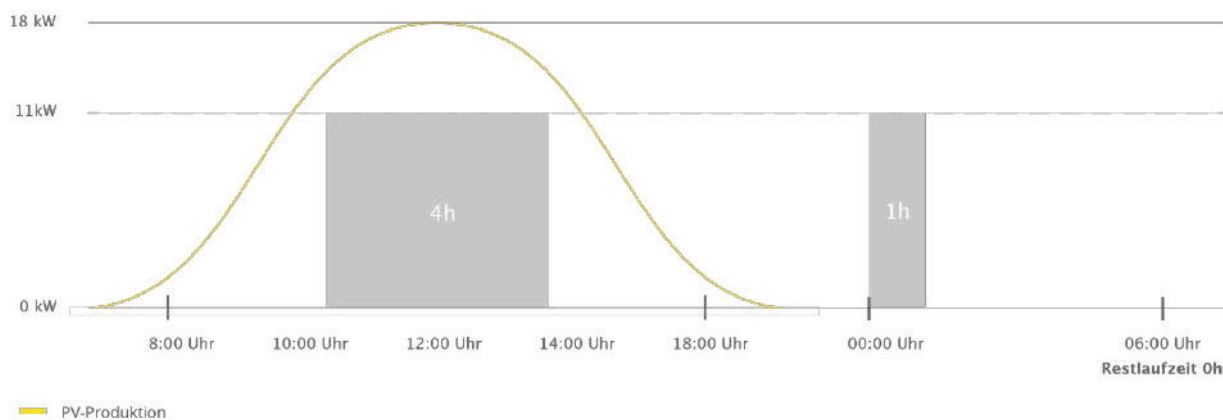

A+ Manuell

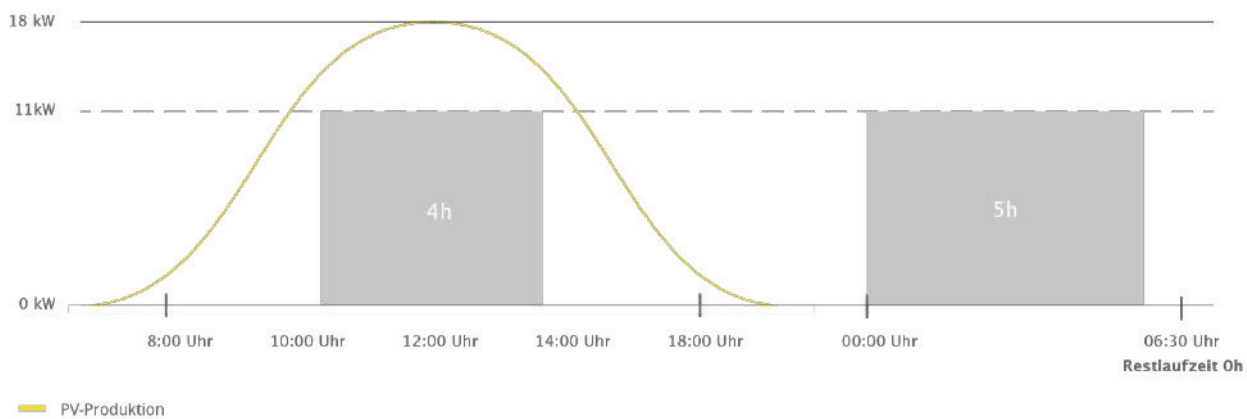

Figure 25 Control A+ automatic & A+ manual



8.9.2 Example: Integration of switching times "outside the opening hours":

If charging stations are installed in semi-public areas, there may be a requirement to enable charging points only during opening hours. The example shows the parameterisation of the switching time mode "locked". (Opening hours Mo - Fr 08:00-18:00)

- Open switching time 1 by clicking on the plus symbol.
- Select weekdays (Mon, Tue, Wed, Thu, Fri)
- Shop closes at 18:00, so set as start time
- Select end time 23:59, as already mentioned in example 1, two switching times are required over midnight.
- Mode - Set switching time to "Locked"
- Confirm with OK.

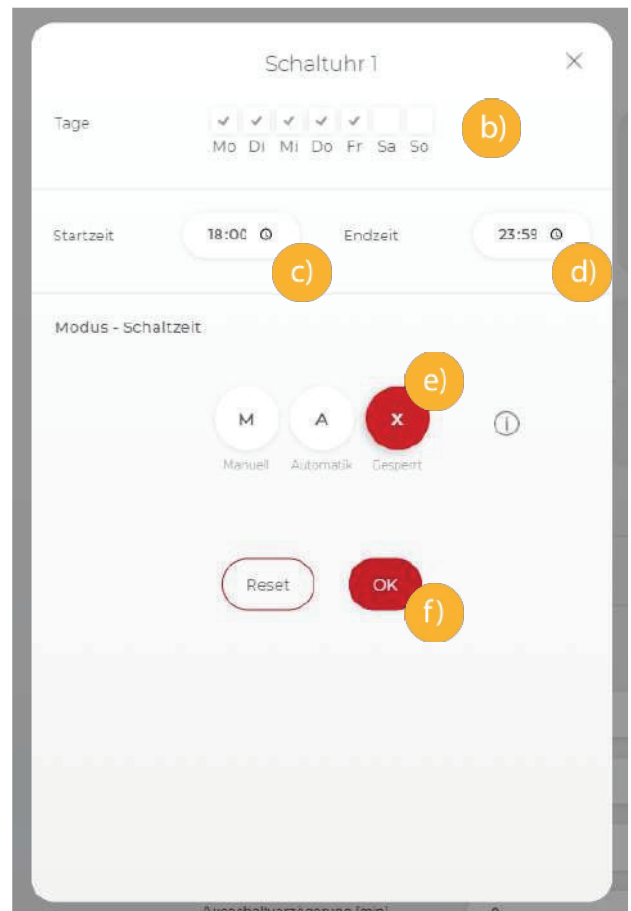
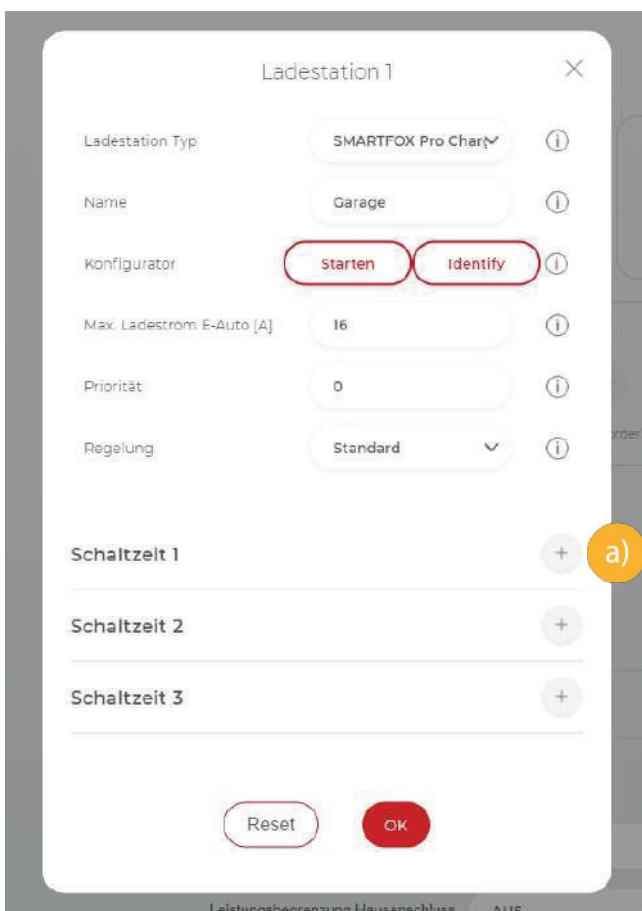



- g) Select timer 2
- h) Select weekdays (Mon, Tue, Wed, Thu, Fri)
- i) Select start time 00:00
- j) Select end time 08:00, shop opens.
- k) Mode -Select "Locked" switching time
- l) Confirm with OK

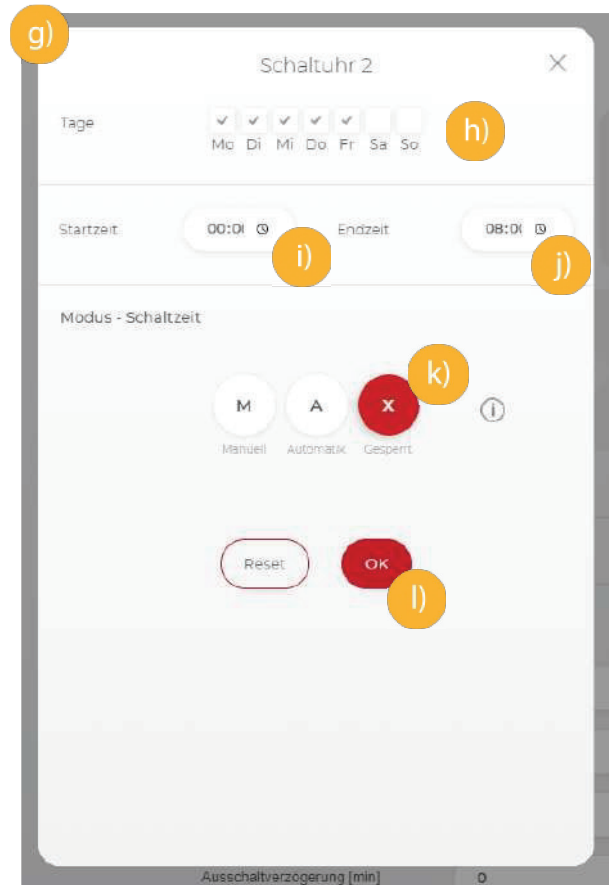

- m) Select timer 3 (weekend lock)
- n) Select weekdays (Sat, Sun)
- o) Select start time 00:00
- p) Select end time 23:59, thus 24h selected
- q) Mode -Select "Locked" switching time
- r) Confirm with OK

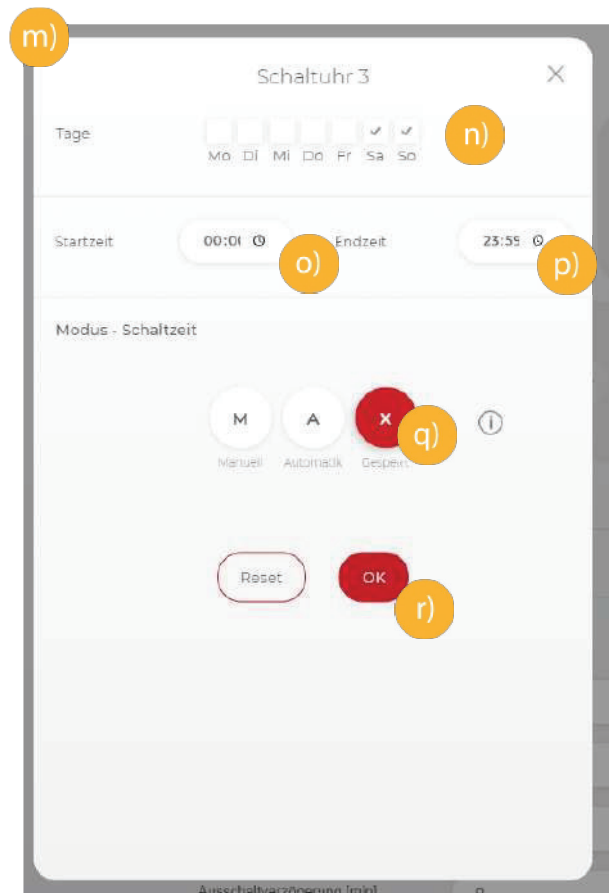



8.10 " Automatic 1-phase / 3-phase changeover

With the integrated, automatic phase switching, you get the most out of your surplus charging. The charging currents defined according to the IEC-62196 & IEC-61851 standard require a certain minimum charging power of electric vehicles (1ph = 6A = approx. 1.3kW; 3ph = 6A = approx. 4.3kW). In order to be able to charge with a pure surplus even when the energy yield of the PV system is low (e.g. bad weather), SMARTFOX Pro automatically selects the best operating point. If there is little energy, 1-phase charging can be started from as little as 1.3kW. If the surplus energy increases, the SMARTFOX Pro automatically switches to 3-phase charging and can now continuously control up to 11kW.

NOTE



Some vehicles are not compatible with automatic phase switching. This concerns some Hyundai Kona / Kia eNiro, Renault Zoe as well as Smart models with (Renault charging technology). As compatibility changes depending on the software version of the vehicle, it is not possible to provide a complete list here. The use of the switchover must be checked in each individual case and deactivated if necessary (see 8.1.7 f).

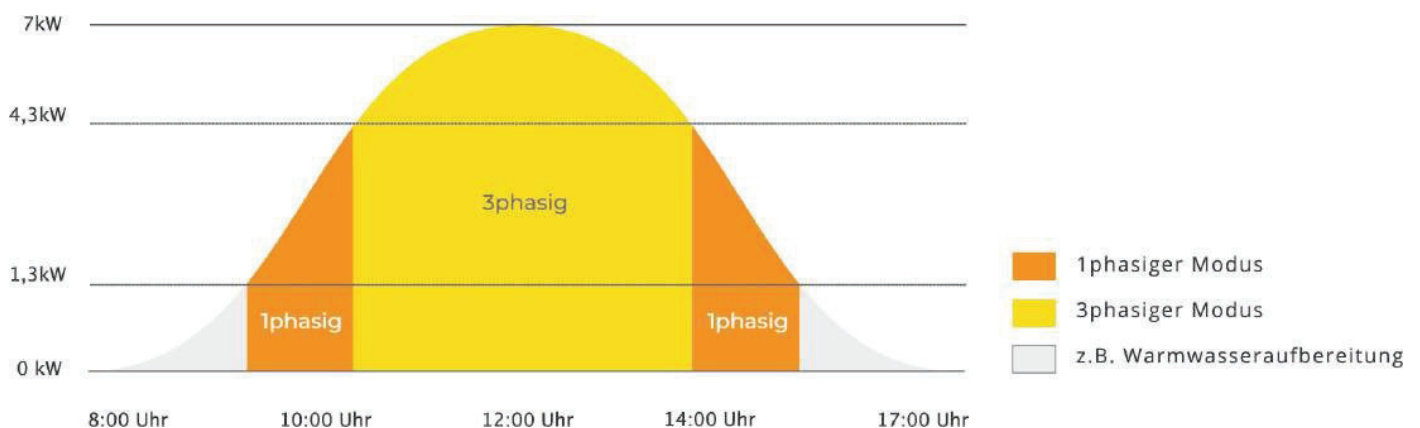
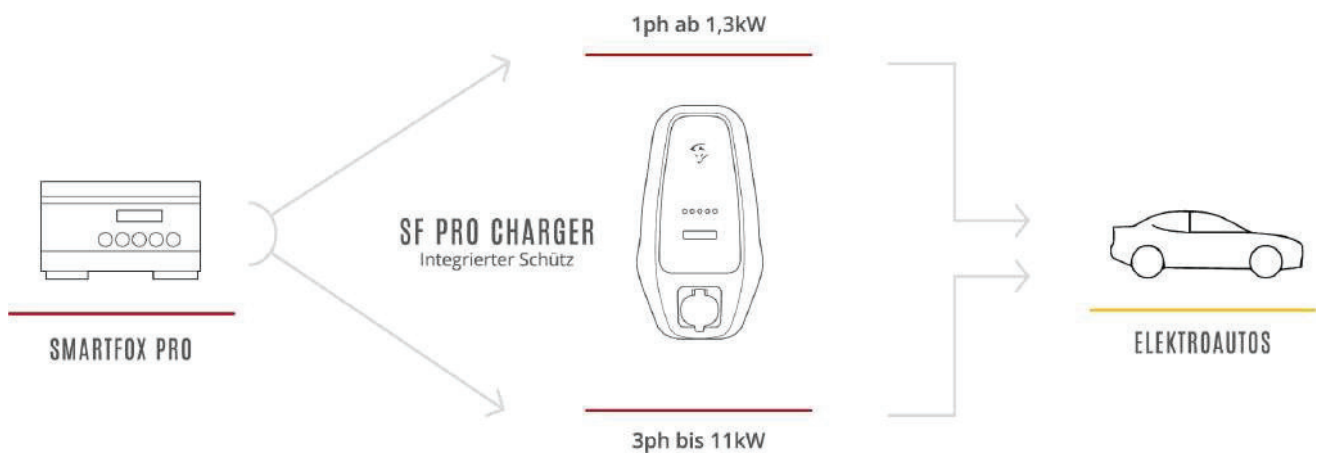



8.11 Charge Stop function (EVU- lock)

Some network operators prescribe a blocking or disconnection via ripple control signal for charging stations. This function can be realised via the S0 input of the SMARTFOX Pro.

Connection

:

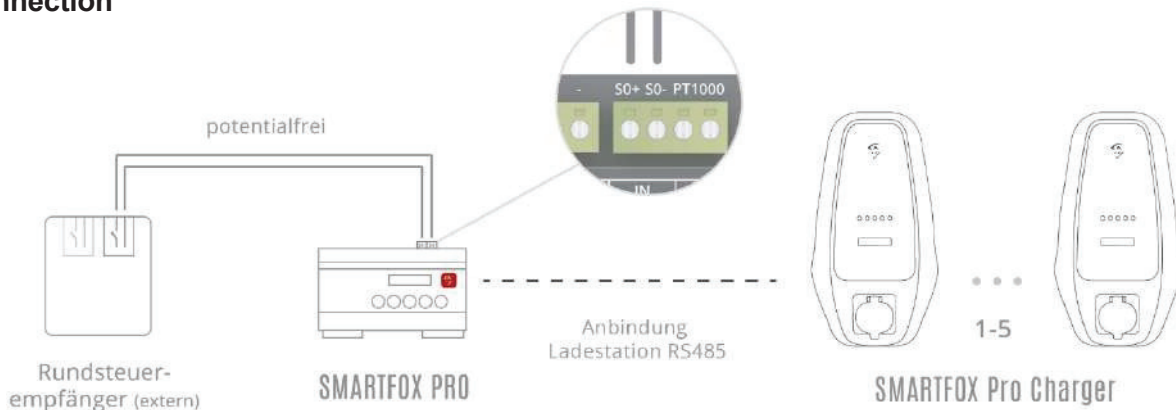

The two wires of the control signal are connected to the S0+ & S0- input of the SMARTFOX. The polarity is irrelevant here. If the normally open contact of the ripple control receiver is actuated, the signal on the SMARTFOX is switched through and the charging stations are blocked. If the charging station is still to charge in surplus mode, the **"Charge Stop Surplus"** function can be selected. If **"Charge Stop"** is selected, the station is completely blocked.

NOTE



The signal transmission to the SMARTFOX must be potential-free; if the ripple control signal is based on 230V, a coupling relay must be used.

- Select the Inputs submenu.
- Select "CarCharge Stop" or "CarCharge Stop Surplus" in the "Input S0" drop-down menu.

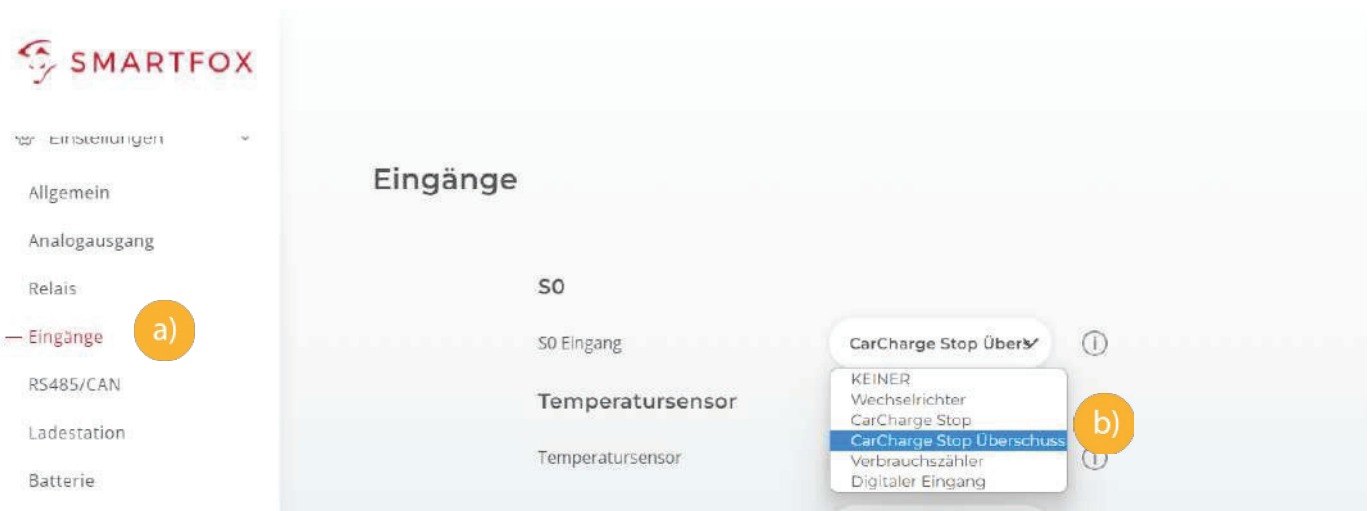

INFORMATION



If the blocking by the network operator is active, the SMARTFOX displays the status "Car Charge Stop" issued.



8.12 Control of several charging stations

This section describes the special features for controlling several charging stations (max. 5). The basic parameterisation of the individual charging points is carried out according to steps 8.1.5 to 8.1.10.

The dynamic load management of the SMARTFOX Pro enables stepless excess charging of up to 5 charging points, as well as dynamic power limitation in order not to overload the house connection fuse or exceed the peak power available from the grid operator. SMARTFOX Pro thus offers an ideal charging solution for smaller businesses or residential complexes that require intelligent, dynamic load sharing.

NOTE



Only several charging stations of one type from the same manufacturer can be integrated.

Schematic structure

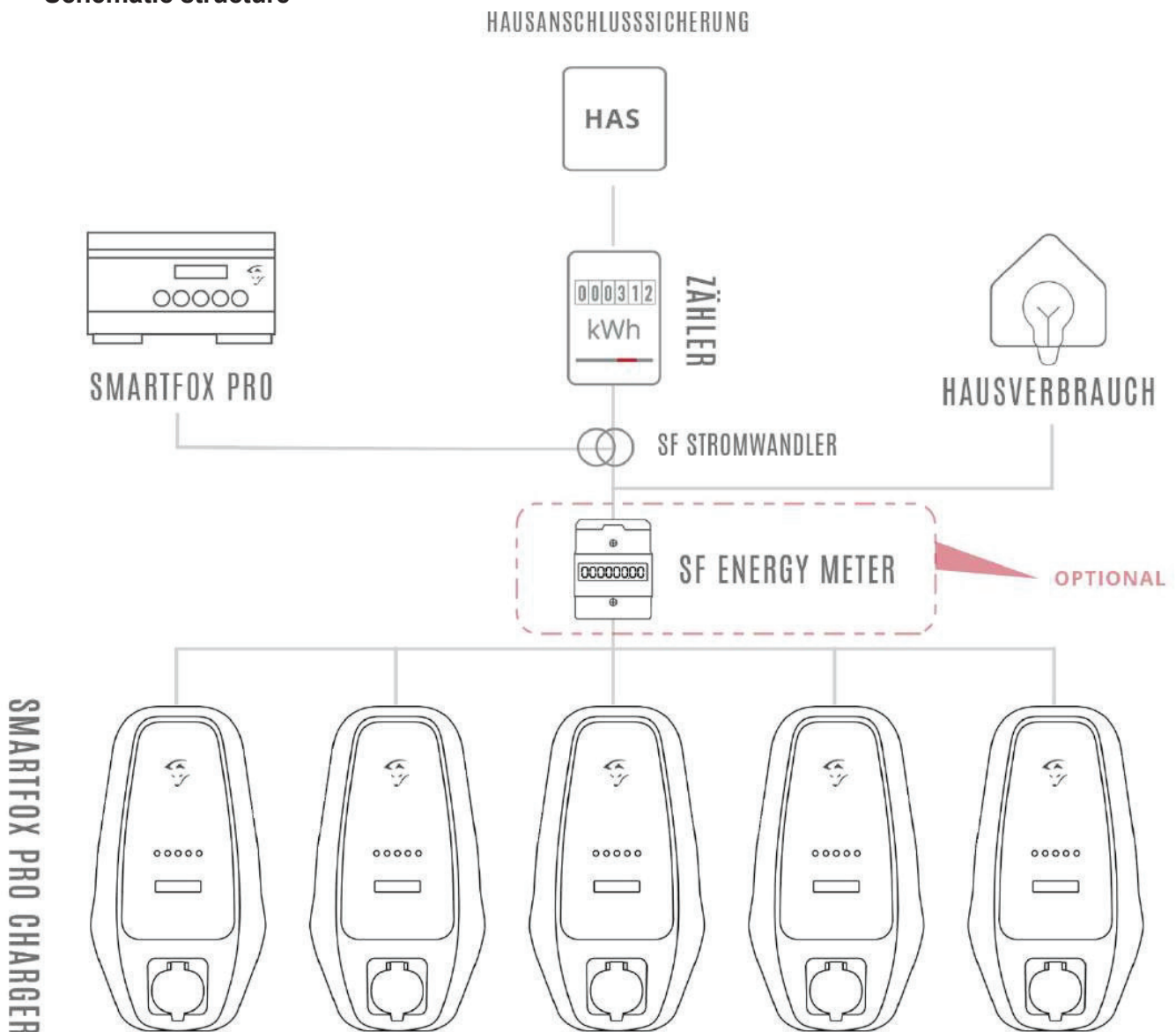



Priorities can be assigned for charging points 1 to 5. Multiple charging stations:

**1= highest priority ... 5=
lowest priority.**

Charging stations with the same priority are controlled in parallel.

- a) Select the charging station to be parameterised.
- b) Assign priority to the charging point and click on Save.

Example screenshots show parallel control of all charging stations with priority 1.

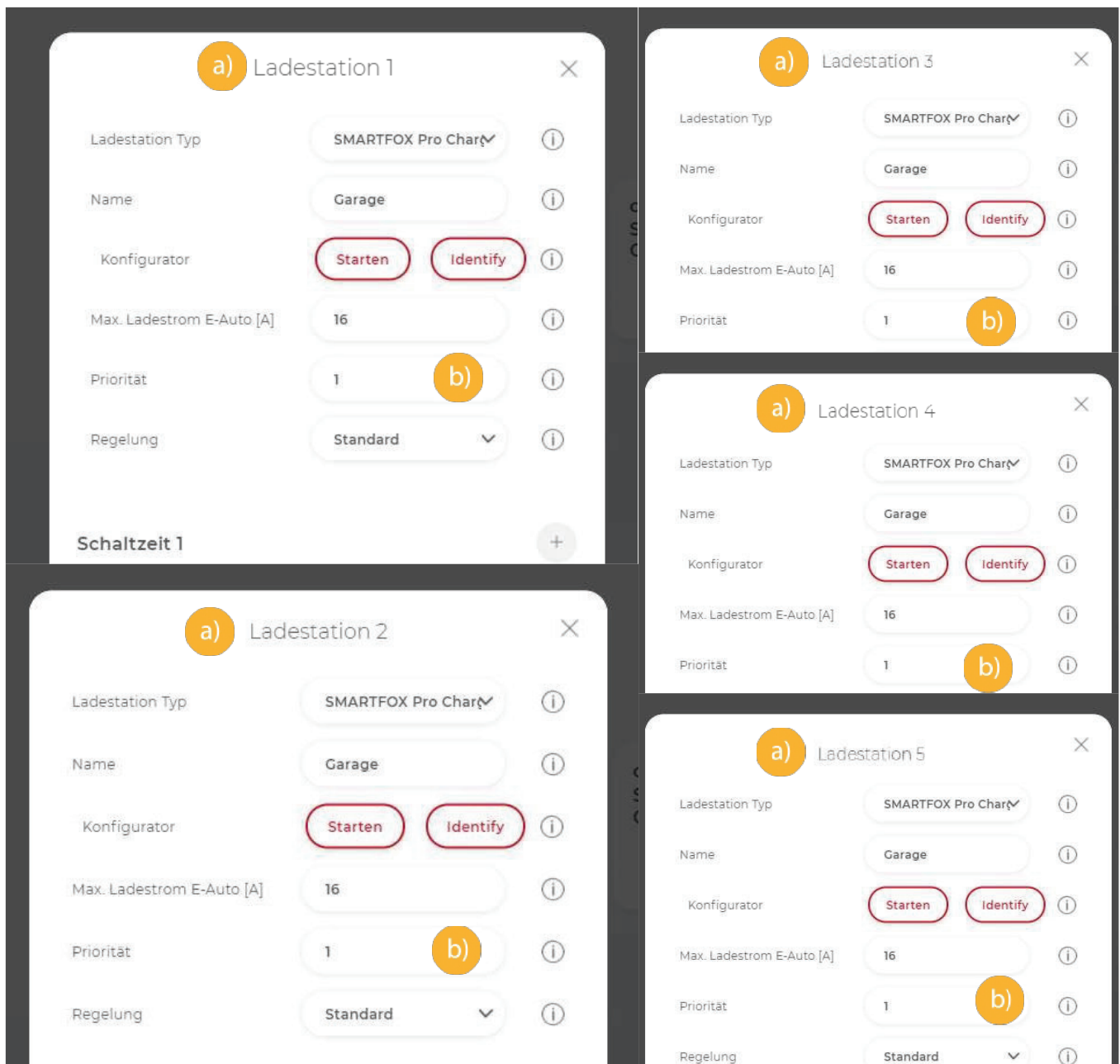



The dynamic house connection limitation can be activated under Control. This is necessary to prevent the house connection fuse from being triggered if many consumers are switched on at the same time (e.g. electric cooker, heat pump...). SMARTFOX recognises the additional consumption and regulates the charging stations back according to the set priorities. This means that several charging stations can also be operated on one connection with little available peak load without any problems (e.g. retrofitting an older residential building, small cable cross-sections...).

8.12.1 Control variants House connection limitation

You can choose between two rule variants

8.12.1.1 House connection limit Power [kW]:

It is regulated to the maximum set mains reference value (Attention: Total house connection point

- c) Set the power limitation of the house connection to "Power [kW]".
- d) Enter limit house connection in kilowatts

The screenshot shows the 'Regelung' (Control) settings. The 'Regelzeit [s]' is set to 5. The 'Leistungsbegrenzung Hausanschluss' (House connection power limitation) is set to 'Leistung [kW]' (Power [kW]), indicated by a yellow circle 'c)'. The 'Limit Hausanschluss [kW]' is set to 30, indicated by a yellow circle 'd)'.

8.12.1.2 House connection limit current [A]:

Individual phase control is carried out according to the set current maximum.

- e) Set the power limitation of the house connection to "Current [A]".
- f) Enter limit house connection in amperes

The screenshot shows the 'Regelung' (Control) settings. The 'Regelzeit [s]' is set to 5. The 'Leistungsbegrenzung Hausanschluss' (House connection power limitation) is set to 'Strom [A]' (Current [A]), indicated by a yellow circle 'e)'. The 'Limit Hausanschluss [A]' is set to 120, indicated by a yellow circle 'f)'.



8.12.1.3 Second level of rules

If another control level is to be monitored in addition to the house connection point, this can be realised by installing a SMARTFOX Energy Meter (see connection diagram item [7.3 Second control level](#)). In this way, for example, the house connection point and the outlet to the underground car park can be monitored. With the use of the SMARTFOX Energy Meter, outlets up to 80A can be monitored. Example 3a) and 3b) from page 76 shows the single phase monitoring incl. second control level.

- a) Open the "External counters" submenu
- b) "Add "SMARTFOX Energy Meter RS485
- c) Start configurator and follow instructions
- d) Select destination for "Sub-counter" values

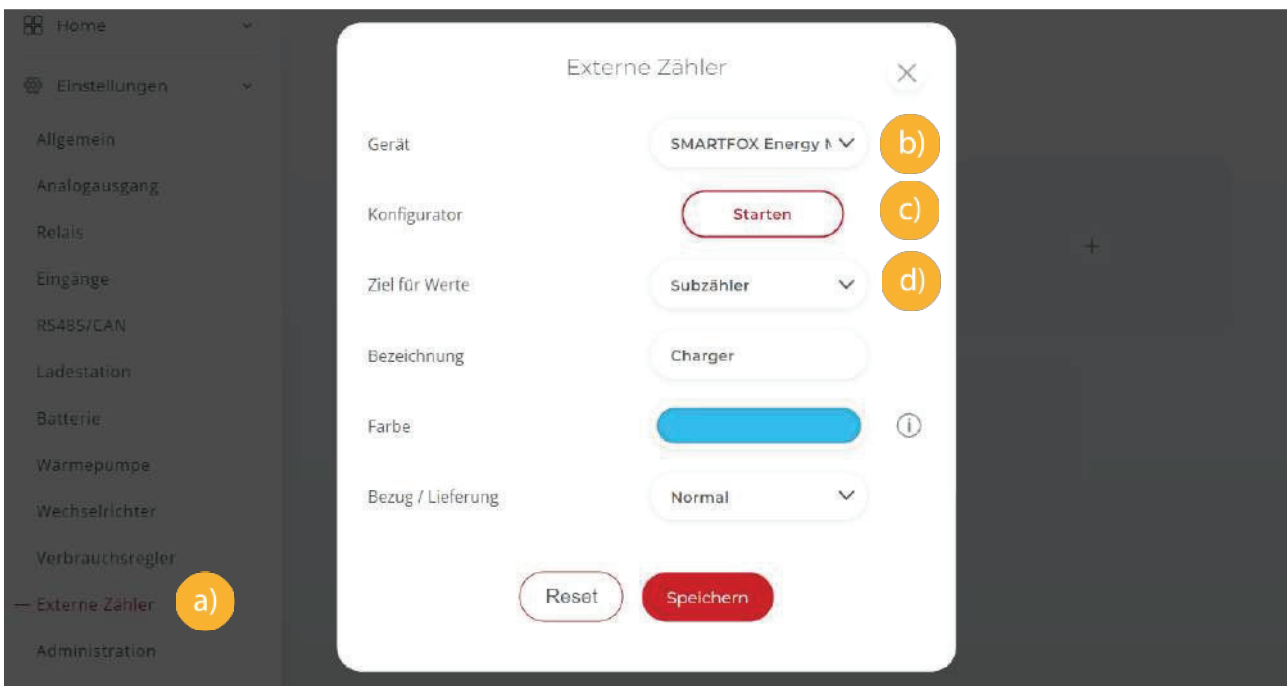



- e) Open the "Charging station" submenu
- f) Set power limitation sub-counter to "current" or "power"
- g) Enter the limit of the sub-counter in amperes or kilowatts.
- h) Select responsible sub-counter

SMARTFOX

Home ▾

Einstellungen ▾

- Allgemein
- Analogausgang
- Relais
- Eingänge
- R5485/CAN
- Ladestation e)**
- Batterie
- Wärmepumpe
- Wechselrichter
- Verbrauchsregler
- Externe Zähler
- Administration

Admin Login ↻

Regelung

Regelzeit [s]	5	i
Leistungsbegrenzung Hausanschluss	Strom [A] ▾	i
Limit Hausanschluss [A]	120	i
Leistungsbegrenzung Subzähler	Strom [A] ▾	i f)
Limit Subzähler [A]	80	i h)
Zuständiger Subzähler	EM1 Charger ▾	i g)
Einschaltverzögerung [min]	0	i
Ausschaltverzögerung [min]	0	i
Zielwert [W]	-20	i
Leistungs Offset [W]	0	i
Analogausgang Aktiv	AUS ▾	i

Example J Control parallel

Max. House connection power: 80A =
 approx. 54kW All charging points: Priority 1

- a.** If all charging stations are in manual mode, the maximum house connection power of 54kW is set up by SMARTFOX Pro on all car chargers in parallel.
- O** If the house consumption increases to e.g. 1.4kW, SMARTFOX Pro readjusts the charging stations in order not to exceed the maximum value of the house connection power of 54kW.

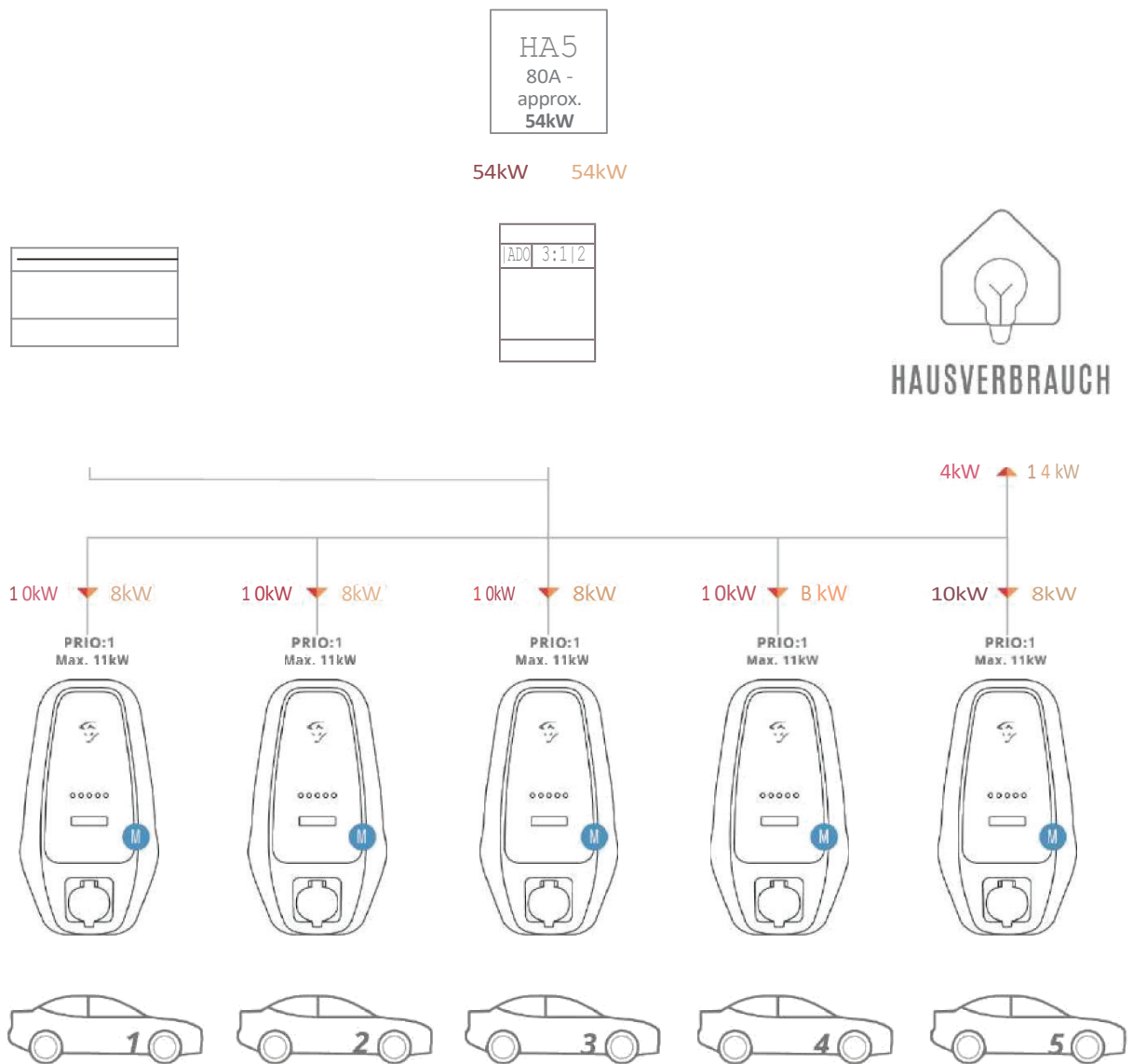

HAS House connection fuse
 Manual mode



Beispiel 2 Unterschiedliche Prioritäten

Max. Hausanschlussleistung: 80A = ca. 54kW
Ladepunkte: 3 unterschiedliche Prioritäten
Wechselnde Fahrzeuge

a.

Alle Fahrzeuge befinden sich im manuellen Modus. SMARTFOX Pro teilt die zur Verfügung stehende Leistung nach eingestellten Prioritäten auf.

Die erste Ladestation hätte die höchste Priorität. Im Beispiel ist kein Fahrzeug angeschlossen.

Somit wird der Überschuss auf die restlichen Ladepunkte verteilt. Die letzte Ladestation, mit der niedrigsten Priorität, erhält somit nur noch eine Ladeleistung von 6kW.

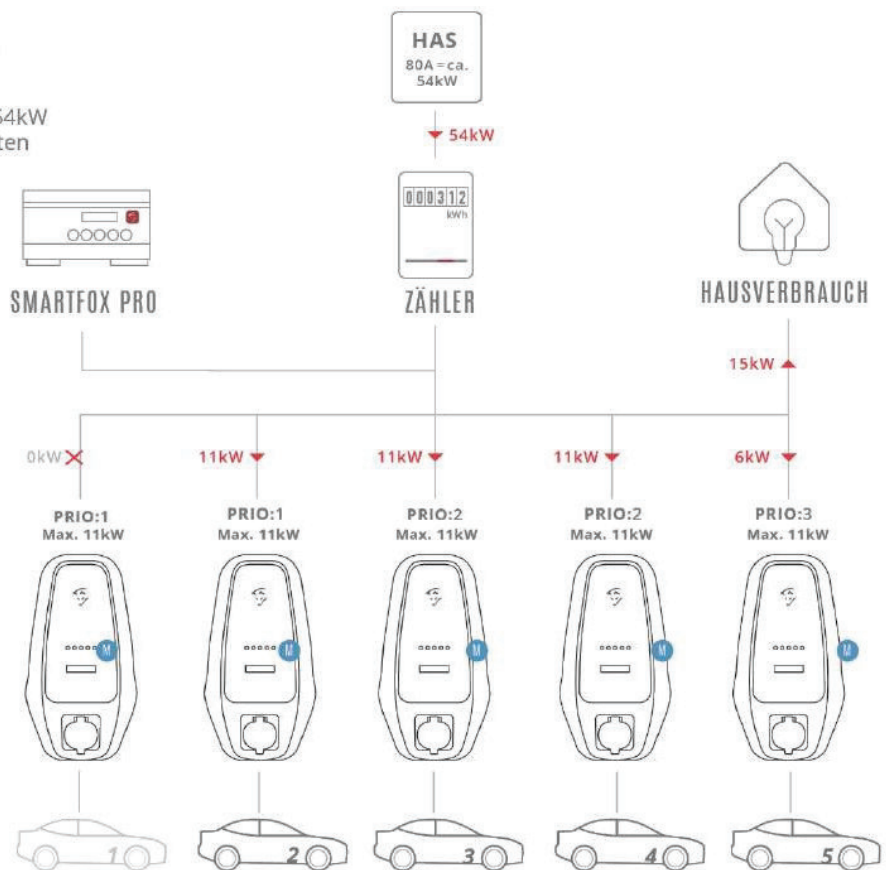

b.

Alle Fahrzeuge befinden sich im manuellen Modus. SMARTFOX Pro teilt die zur Verfügung stehende Leistung nach eingestellten Prioritäten auf.

Im Beispiel (b.) hat sich nun die Fahrzeugbelegung an den Ladestationen geändert.

Zusätzlich ist der Hausverbrauch auf 23kW gestiegen. Die letzte Ladestation, mit der niedrigsten Priorität, erhält somit nur noch 9kW.

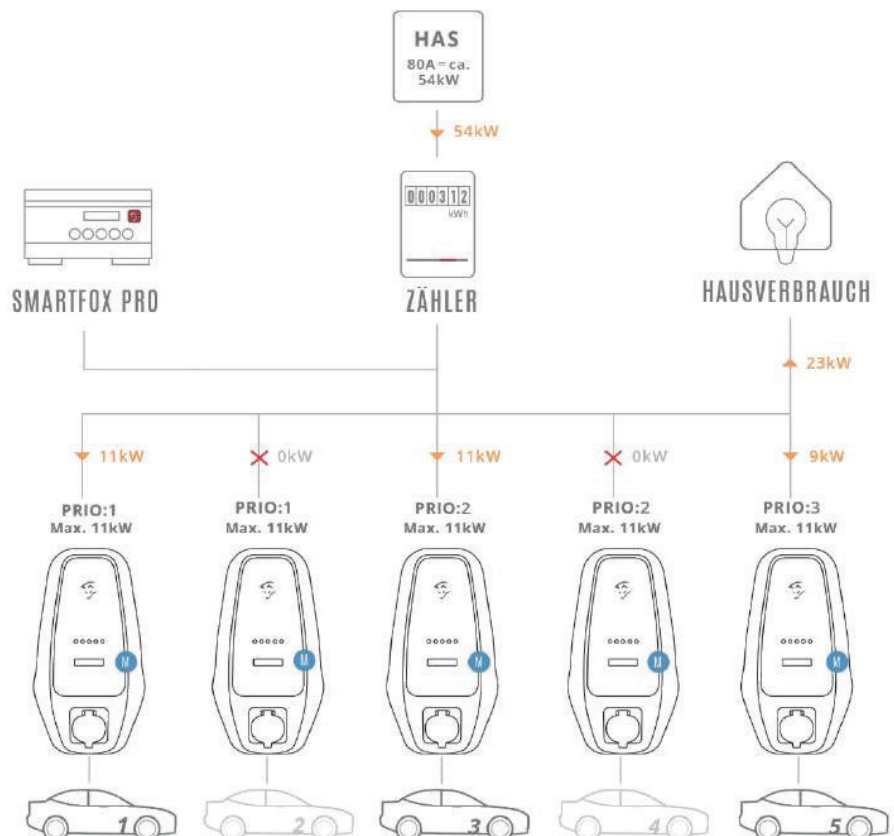

Beispiel 3a)

Einzelphasenüberwachung inkl. 2. Regelebene

Max. Hausanschlussleistung: 120A = ca. 81kW
 Ladepunkte: Alle Ladepunkte Priorität 1
 Wechselnde Fahrzeuge

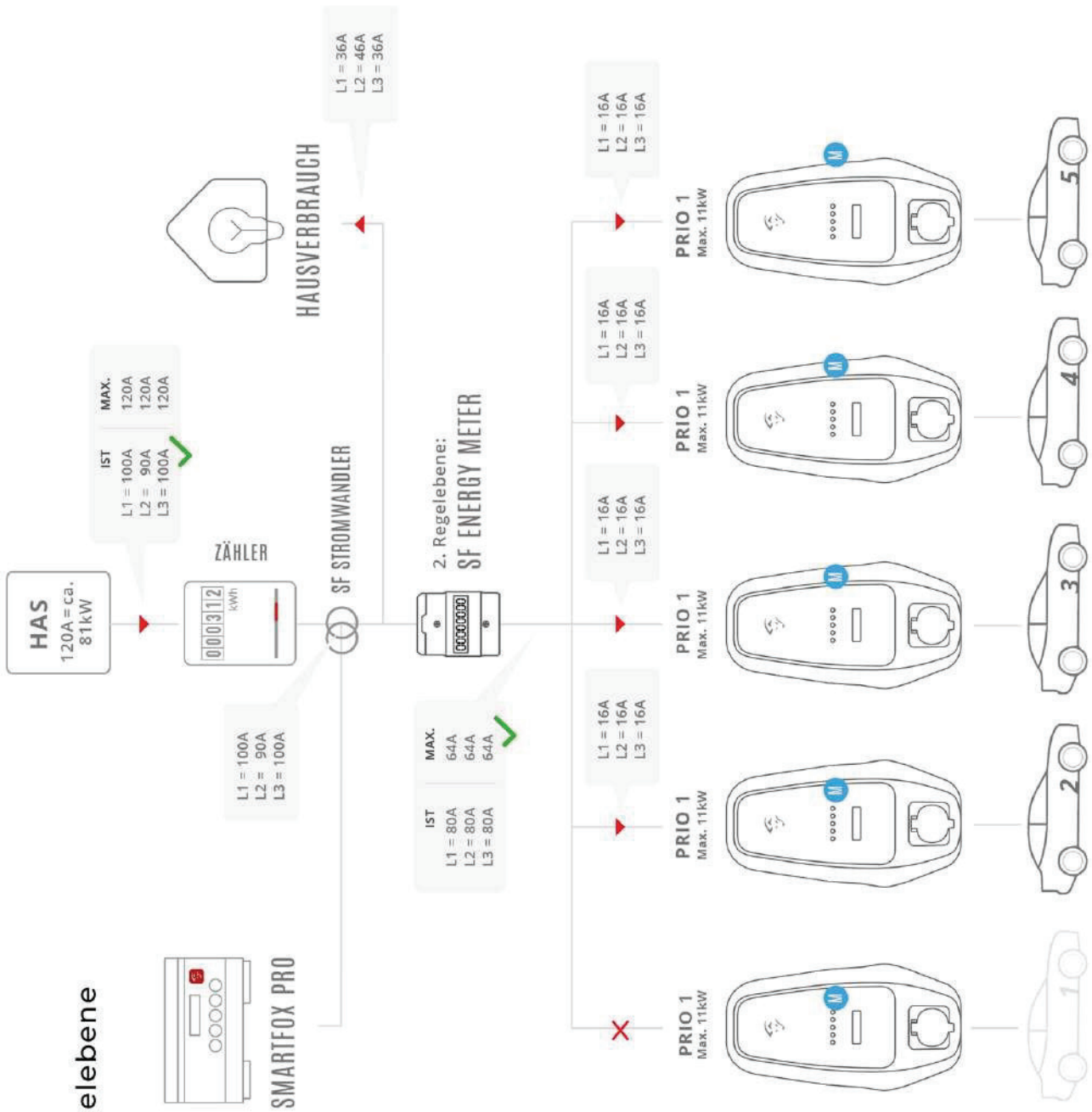

a. Befinden sich alle Ladestationen im manuellen Modus und besitzen dieselbe Priorität, wird der maximal zur Verfügung stehende Strom pro Phase parallel auf die Ladestationen aufgeteilt.

Wie im Beispiel ersichtlich werden im Moment vier Fahrzeuge geladen. Weder am Hausanschlusspunkt, noch in der zweiten Regelebene wird eine Phase überlastet.

Es ist somit kein eingreifen der Hausanschlussbegrenzung erforderlich.

Example 3b)

Individual phases monitoring in cl. 2. rege levels

Max. House connection power: J 20A = approx. 81 kW
 Charging points: All charging points Priority 1
 Changing vehicles

b.

Compared to case a), the situation has changed.

At charging point 1, a vehicle charged 1-phase. In addition, the consumption in the building has increased significantly.

An overload at L1 can be detected at the measuring point of the second control level.

There is an overload on L3 at the HdU connection point.

Both measured values require an intervention of the house dn-connection overwrdChung. The energy manager will dynamically reduce the power of the charging stations to fall below the defined maximum values.

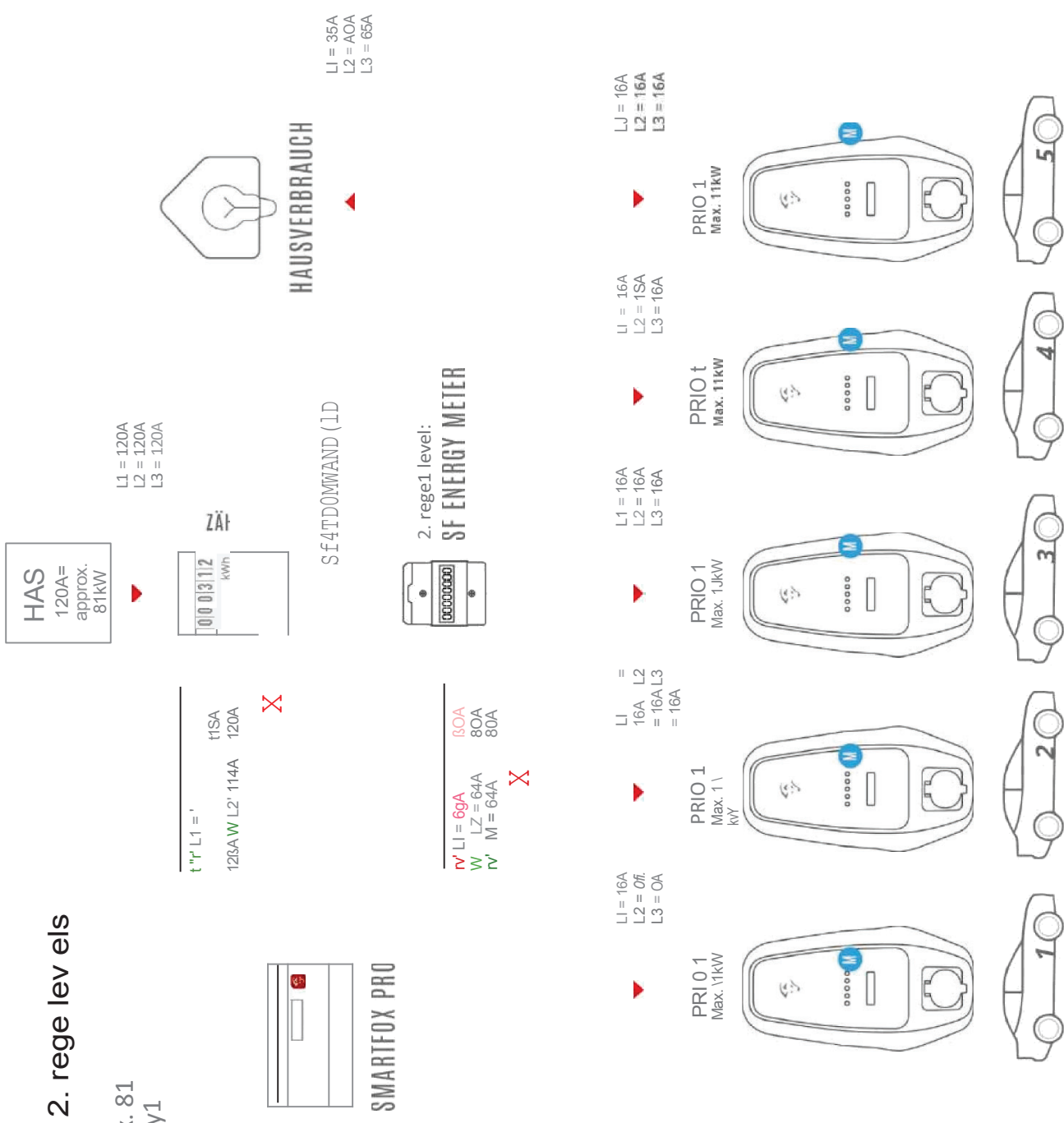



9 Operation

After installation and initial commissioning, the SMARTFOX Pro Charger is ready to charge your vehicle.

9.1 Charging cable

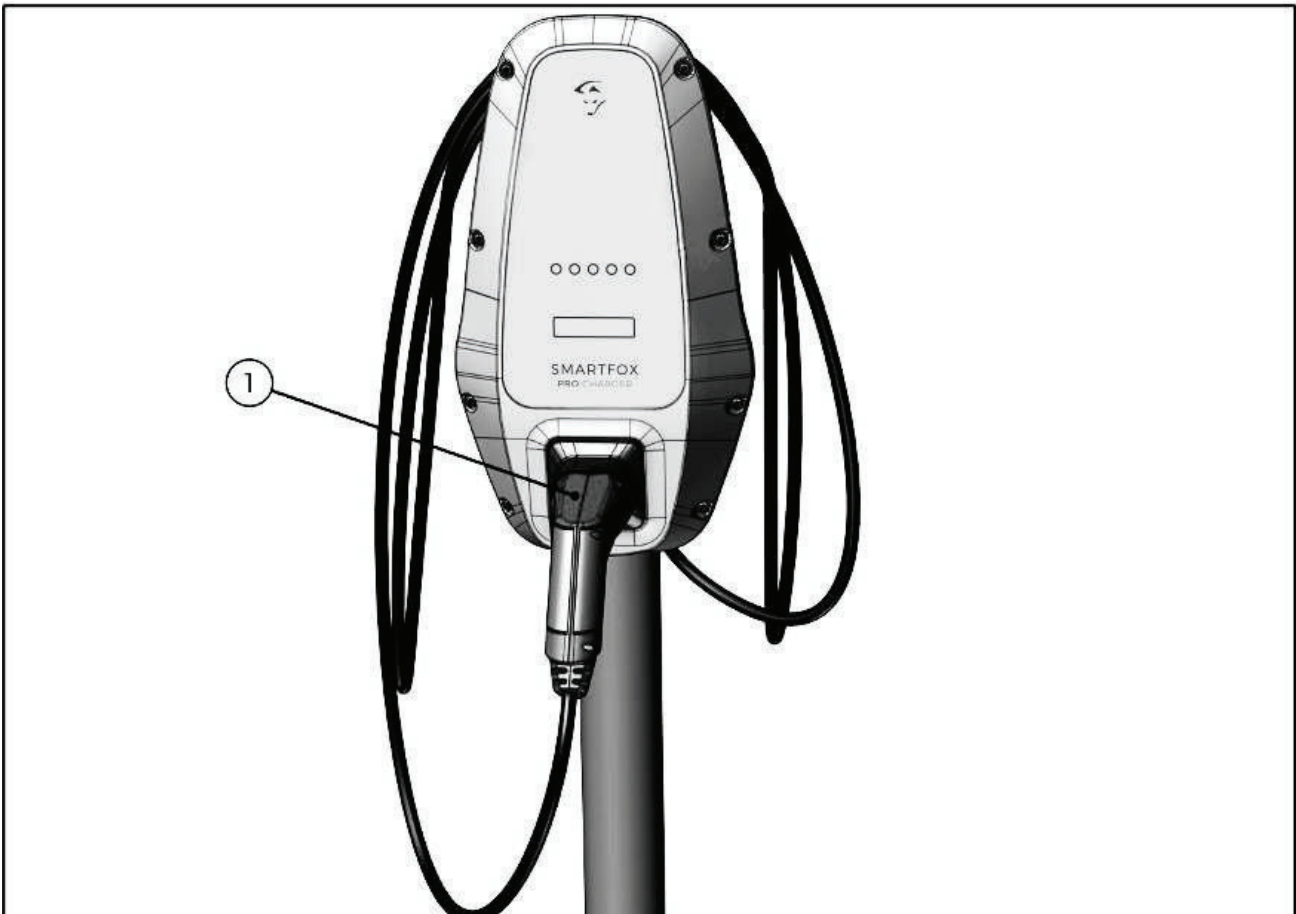

Figure 26 Charging cable

No.	Description
1	Charging cable

Pin:

Remove the charging cable (1) from the holder. To do this, lift the plug of the charging cable at the front and then pull it out of the holder. Then plug the charging cable into the vehicle. If you encounter any problems during this step, please check whether dirt or similar objects are obstructing the plug-in process. Also observe the manufacturer's instructions for your electric vehicle.



Staking:

To end the charging process or after the charging process has ended automatically, disconnect the charging cable from the vehicle. It may be necessary to unlock the vehicle again or press a separate release button (if necessary, please refer to the vehicle operating instructions). The charging cable can then be hooked back into the holder. To do this, insert the charging cable into the holder and press the plug down at the front. This fixes the charging cable in the holder again and it is in the parking position.

9.2 Display elements

9.2.1 LED status display

To visualise the current status, the charging station is equipped with an LED display.

9.2.1.1 Ready for charging

The charging station is in standby mode and ready for charging. The five LEDs light up green continuously.



9.2.1.2 No surplus

If the charging station is in surplus mode and there is not enough power (minimum charging power 1ph=1.3kW; 3ph=4.3kW) available to start charging, the charging station flashes green. Charging starts automatically as soon as there is enough surplus power.





9.2.1.3 Charging in progress

When the vehicle is plugged into the charging station, the colour of the LEDs changes from green to blue. A clear, single switching is heard in the wallbox and the charging process begins.



9.2.1.4 Charging process completed

When the on-board traction battery is fully charged or the charging process has been paused for another reason, e.g. phase switching, the indicator changes from a steady blue light to a flashing blue light.



9.2.1.5 Charge pause

If the charging station is in charging pause, the indicator lights up yellow. This indicator signals e.g. an overtemperature. The charging process is automatically resumed after it has cooled down.





9.2.1.6 Communication error (RS485)

If there is no connection to the SMARTFOX Pro Energy Manager for more than one minute, the display flashes violet and thus visualises a communication error. To rectify the error, try restarting the system or check the RS485 line and parameterisation.



9.2.1.7 Error

If the charging station detects an error, this is indicated by the LED display lighting up red. Possible errors can be: charging cable defective, DC fault current detection has triggered or other errors. Errors can possibly be reset or rectified by disconnecting and reconnecting the charging cable and restarting the system. If the error still occurs, contact the installer or service partner.



9.2.2 Energy meter

The status of the energy meter can be read via the shop window.

The meter automatically switches between the display of the two integrated meter movements.

Counter 1 displays the total charged energy value in kWh. **Counter 2** shows the energy value of the active or last charging process hundhiun





10 Maintenance

The activities required for maintenance are explained in the following chapters: Inspection, cleaning, maintenance, spare parts management and repair.

NOTE



General notes

- The following information must be observed; in addition, the instructions in the respective original manufacturer's documentation must not be disregarded.
- The operator assumes responsibility for ensuring that this information is also taken into account.
- All necessary measures for inspection, repair and maintenance shall be carried out in accordance with the national regulations of the country of installation.
- All maintenance, inspections and repeat inspections defined by standards, laws, directives and other regulations shall be to be planned and carried out or commissioned by the operator.

10.1 Inspection

Inspection comprises the measures for determining and assessing the actual condition of a product. It is used for the early detection of faults, malfunctions or hazards and must be carried out by the user. This inspection is necessary to ensure safe and trouble-free operation.

The following points must be observed during inspections:

- Visual inspection for damage, corrosion, leakage or deformation of the product.
- Visual inspection for contamination and dust deposits
- Check that all warning, mandatory and prohibition signs on the product are in proper condition.
- In addition, a functional test with a vehicle or a vehicle simulator is recommended if regular loads are not carried out.



10.2 Cleaning

The following points must be observed when cleaning the product:

- The product must be disconnected from the power supply before cleaning.
- Cleaning work may be carried out by laypersons who have read and understood the operating and maintenance instructions as well as all safety instructions.

NOTE



General instructions for cleaning work

The charging station may only be cleaned with a soft, non-scratching cleaning cloth.

Cleaning activities:

- Clean the entire charging station including all accessories and variants with a damp cloth as required to remove dust and dirt.

10.3 Maintenance

Maintenance recommendation: annually

NOTE



The following points must be observed during maintenance work:

- Before maintenance work, the product must be disconnected from the power supply.
- Maintenance work may only be carried out by DAfi GmbH or certified SMARTFOX partners.
- During all maintenance work, appropriate precautions shall be taken to safely prevent unintentional or unauthorised switching on of the product by the maintenance personnel themselves or by third parties.

All prerequisites necessary for operation must also be fulfilled for maintenance. (e.g.: Access to the power supply, access to the operating instructions, presence of the charging card or other enabling media...).



10.4 Spare parts and Wear parts

For information on spare and wear parts, see the spare and wear parts list in the appendix, see chapter 11.2. Spare and wear parts must be replaced after different periods of operation depending on wear.

WARNING



Defect during operation

There are different hazards when using non-original spare parts and during conversions.

- Only use original spare parts according to the spare and wear parts list.

10.5 Repair

Maintenance includes activities that go beyond maintenance work as well as activities for trouble-free operation. After inspection and maintenance, repair completes the maintenance cycle and ensures a long service life for your charging station.

WARNING



Different hazard events

During repair work on the product, additional danger points could be accessible.

- Repair work may be carried out exclusively by DAfi GmbH or certified SMARTFOX partners. These persons must also have read and understood this documentation.



10.6 Recurring Inspection

The recurring inspection according to E 8101 (VDE 0105-100/ A1: 2017-06) must be carried out annually by an electrotechnical specialist. This ensures operational safety. The function of the charging station and all safety devices belonging to the system are tested in accordance with the currently valid standards and laws.

This includes all shutdown conditions including the back-up fuse according to the data sheet or initial commissioning protocol. In addition, annual maintenance by DAfi GmbH or certified SMARTFOX partners is recommended.

10.7 Decommissioning

To take the product out of operation for a short period of time, the following steps must be carried out in compliance with the safety instructions in chapter 3.4:

- End charge
- Disconnect the type 2 charging cable from the vehicle
- Disconnect the power supply - Switch off the power supply to the product.
- Secure product against unauthorised recommissioning

10.8 Disassembly

The following steps must be carried out before dismantling the product for final decommissioning in addition to the steps listed above for short-term decommissioning:

WARNING	
	<p>During dismantling work, there are additional dangers due to improper work.</p> <p>If the product is not dismantled properly, there may be danger to persons or damage to the product.</p> <ul style="list-style-type: none">• Dismantling work at the product may exclusively be carried out by qualified electrotechnical personnel.



The following points must be observed when dismantling the product:

- After decommissioning (see chapter 10.7), the charging station must be disconnected from the power supply.
- Transport may only be carried out in compliance with the transport regulations.
- If the product is stored after disassembly, the requirements at the storage location must be met.
- If the product is disposed of, this must be done in compliance with the disposal principle (see chapter 10.9).

10.9 Disposal

Principle

INFORMATION	
	<p>Disposal - Principle</p> <ul style="list-style-type: none">• Dispose of the parts of the product within the scope of the final decommissioning in an environmentally friendly and sorted manner (metal to the respective metal scrap, plastic to the plastic waste, electronics to the electrical waste according to the legal requirements etc.).

Before disposing of materials and parts of the product, check their recyclability. Recycle as much as possible. Careless or incorrect disposal can cause incalculable damage. Dispose of materials and parts of the product in a way that is demonstrably compatible with people, nature and the environment. Follow the manufacturer's instructions and the relevant laws and regulations.



11 Appendix

11.1 Drawings - Drilling template (unit: mm)

The drilling template is located on the inside of the box (see illustration below).

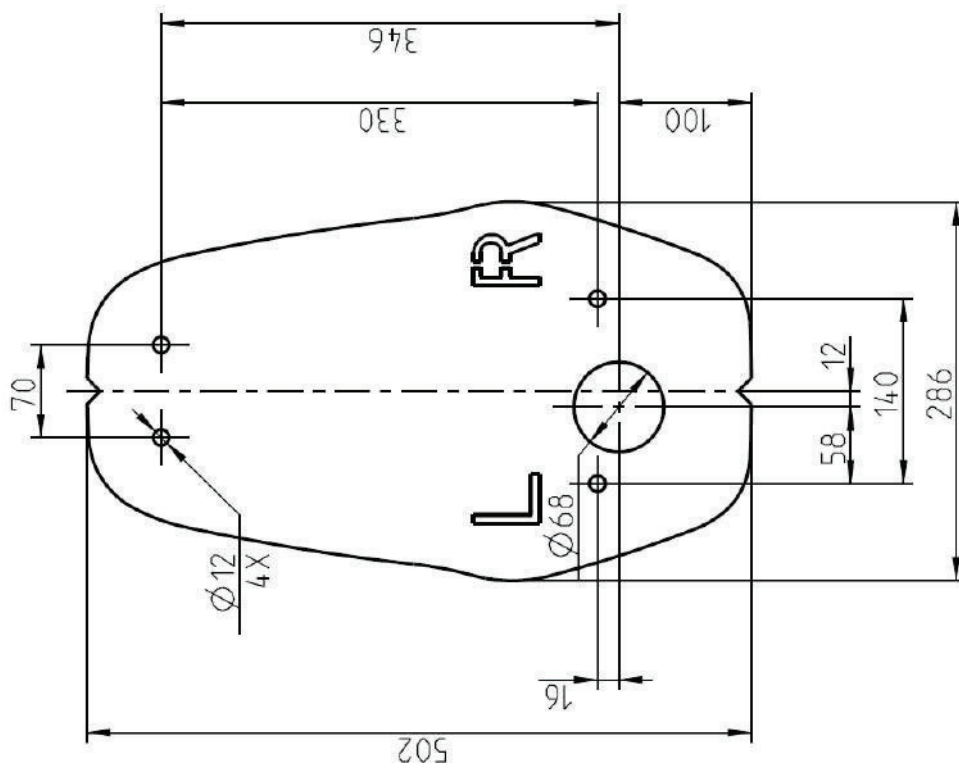
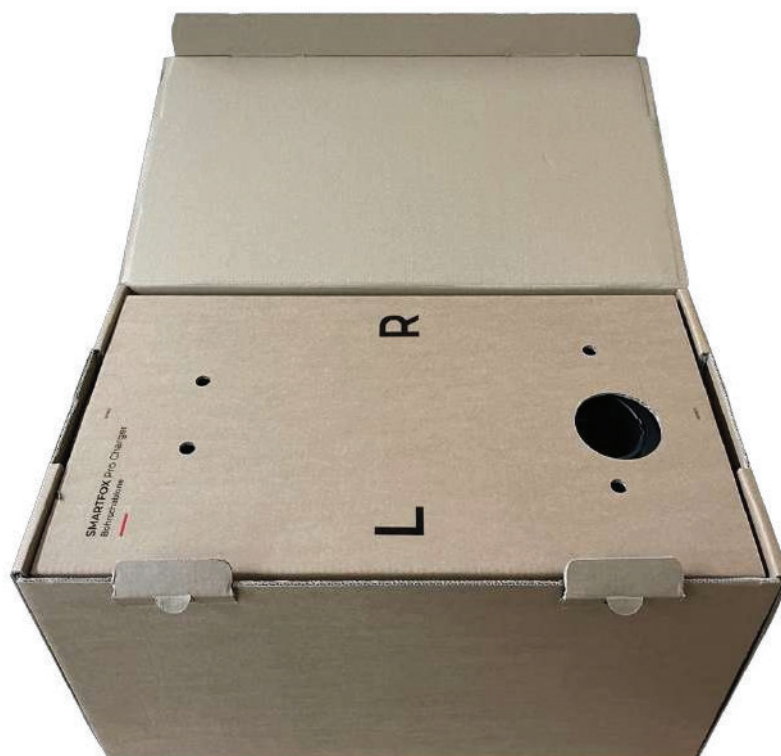

Figure 27 Drilling template & cardboard (bottom part)





11.2 Spare parts and Wear parts

Designation
Bushing incl. sealing ring
Actuator cable
Box cover incl. sealing ring
Housing upper part
Housing lower part
Type2 plug holder
Contactor, 11 kW
SMARTFOX Energy Meter
Power supply unit 12 V, 15 W
Glass tube fuse, 4 A
Relay 1ph/3ph switching
Charging cable, 3-phase, 16 A

Table 7 Spare and wear parts

11.3 List of units

Abbreviation	Meaning
kW	Kilowatt
Hz	Hertz
V	Volt
°C	Degree Celsius
Nm	Newton metre
%	Percent
mm	Millimetre
m	Metre
s	Second
min	Minute
h	Hour
kg	Kilogram

Table 8 List of units



11.4 Packaging icons









ICON / Symbol	Description	ICON / Symbol	Description
	The charging station was manufactured in Austria		Optimal use of your photovoltaic energy
	The charging station is weather resistant		Top price-performance ratio
	With SMARTFOX Pro Energy manager compatible		100 % sun in the tank
	The charging station has been subjected to the conformity assessment procedure and complies with the legal requirements.		App and monitoring possible

Table 9 Packaging icons



11.5 EU Declaration of Conformity



EU-Konformitätserklärung

EU declaration of conformity

Name/Anschrift des Ausstellers: <i>Issuer's name and address:</i>	DAfi GmbH Niedernfritzerstraße 120 5531 Eben im Pongau, AUSTRIA
Produktbezeichnung: <i>Product:</i>	Ladestation für Elektrofahrzeuge Charging Station for electric vehicles
Markenname: <i>Brandname:</i>	SMARTFOX
Typenbezeichnung: <i>Type designation:</i>	Pro Charger

Das bezeichnete Produkt erfüllt die Bestimmungen der Richtlinie / *The designated product is in conformity with the European Directive:*

Niederspannungsrichtlinie (2014/35/EU) / Low Voltage Directive
RoHS-Richtlinie (2011/65/EU) / RoHS Directive
EMV -Richtlinie (2014/30/EU) / EMC Directive

Die Übereinstimmung des bezeichneten Produktes mit den Anforderungen der Richtlinie wird durch die technische Dokumentation sowie die vollständige Einhaltung folgender Normen nachgewiesen / *The technical documentation and full compliance with the standards listed below proves the conformity of the product with the requirements of the above-mentioned EC Directive:*

ÖVE/ÖNORM EN 61000-3-12:2012
ÖVE/ÖNORM EN 61439-1:2012
ÖVE/ÖNORM EN 61439 -2:2012
ÖVE/ÖNORM EN 61851-1:2020
ÖVE/ÖNORM EN 62196-1:2015
ÖVE/ÖNORM EN 62196-2:2017

Die oben genannte Firma hält Dokumentationen als Nachweis der Erfüllung der Sicherheitsziele und die wesentlichen Schutzanforderungen zur Einsicht bereit. / *Documentation evidencing conformity with the requirements of the Directives is kept available for inspection at the above manufacturer.*

CE marking date:
2021

Hermann Buchsteiner
Geschäftsführer

Eben im Pongau, März 2021



Further information can be found on our website at www.smartfox.at (current version in the download area).

DAfi Ltd.

Niedernfritzerstr. 120, 5531 Eben im Pg., AUSTRIA

Tel.: +43 (0)6458 20160

Mail: office@smartfox.at

UID: ATU67186948 FN379380m

 [Instagram](#) (Smartfox_energy_management)

 [Facebook](#) (Smartfox - Energy Management System)

 SMARTFOX Energy Management

 [YouTube](#) (Smartfox - Energy Management)