

Smart  
connections.

## Installation and Operation manual

PIKO MP plus

---

## Legal notice

KOSTAL Solar Electric GmbH  
Hanferstraße 6  
79108 Freiburg i. Br.  
Germany  
Phone +49 (0)761 477 44 - 100  
Fax +49 (0)761 477 44 - 111  
www.kostal-solar-electric.com

## Proper use

The inverter converts direct current into alternating current. This can be used as follows:

- For self-consumption
- For feed-in into the public grid
- For storage in a battery storage

The device may only be used in grid-connected photovoltaic systems within the permissible power range and under the permissible ambient conditions. The device is not intended for mobile use.

Inappropriate use may lead to injury or even death for the user or third parties. Material damage to the device and other equipment can also occur. The inverter may therefore only be used for its intended purpose.

All components fitted on the inverter or in the PV system must satisfy the standards and guidelines that apply in the country of installation.

## Exclusion of liability

Any use that differs from that described under "Proper use" or goes beyond the stated intended purpose, is considered inappropriate. The manufacturer accepts no liability for any damage resulting from this. Modifications to the inverter are prohibited. The inverter may only be used if it is safe to operate and is in a technically perfect condition. Any instance of misuse will result in the termination of the warranty, guarantee and general liability of the manufacturer.

Only a qualified electrician may open the device. The inverter must be installed by a trained electrician (according to DIN VDE 1000-10 or BGV A3 accident prevention regulations or an internationally comparable standard) who is responsible for observing the applicable standards and regulations.

Work that could affect the electrical power system of the relevant energy supply company at the site of the solar power feed-in, may only be carried out by qualified electricians expressly authorised (licensed) by the energy supply company. This includes changes to the factory-preset parameters. The installer must always observe the regulations of the energy supply company.

Factory settings may only be changed by qualified electrical installers or persons with at least comparable or higher technical qualifications, e.g. foremen, technicians or engineers. When doing so, all requirements are to be observed.

## IMPORTANT INFORMATION

The inverter may only be installed, maintained and repaired by a trained and qualified electrician.

The electrician is responsible for ensuring that the applicable standards and regulations are observed and implemented. Work that could affect the electrical power system of the relevant energy supply company at the site of the solar power feed-in, may only be carried out by qualified electricians expressly authorised (licensed) by the energy supply company.

This includes changes to the factory-preset parameters.

## Table of contents

<b>1</b>	<b>General information .....</b>	<b>5</b>
1.1	Accessories .....	5
1.2	Documents .....	5
1.3	Liability, warranty .....	5
1.4	Contact .....	5
1.5	Monitoring portal .....	6
1.6	EU Declaration of Conformity .....	6
<b>2</b>	<b>Abbreviations .....</b>	<b>6</b>
<b>3</b>	<b>Safety .....</b>	<b>7</b>
3.1	Designated use .....	7
3.2	Target group .....	7
3.3	General safety instructions .....	8
3.4	Labels and symbols .....	9
3.4.1	Safety marks .....	9
3.4.2	Keywords .....	9
3.4.3	Signs, labels and safety marks on the device .....	10
<b>4</b>	<b>Description .....</b>	<b>11</b>
4.1	Scope of delivery .....	11
4.2	Structure of the device .....	11
4.3	Exemplary connection .....	12
4.4	Connections, communication, and DC/AC .....	12
4.5	Connection cables .....	13
4.6	Display .....	14
4.7	Cooling .....	14
4.8	Grid monitoring .....	14
4.9	Data communication .....	14
4.9.1	"COM1" and "COM2" .....	15
4.9.2	Modbus RTU data connecting cable .....	15
4.9.3	Alternative RS485 data connecting cable .....	16
4.9.4	LAN .....	16
4.10	Connection peculiarities .....	16
4.11	Data display .....	16
4.11.1	Data storage .....	17
<b>5</b>	<b>Installation .....</b>	<b>17</b>
5.1	Safety instructions for assembly and installation .....	17
5.2	Mounting the inverter .....	19
5.3	Preparing AC connection .....	19
5.3.1	Residual current circuit breaker .....	19
5.3.2	AC cables .....	20
5.3.3	Assembling the AC plug .....	20
5.3.3.1	Preparing cables .....	21
5.3.3.2	Fitting cable to AC plug .....	21

---

5.4	Preparing DC connection.....	23
5.5	Connecting battery to the inverter.....	24
5.6	Connecting inverter and switching AC on.....	26
<b>6</b>	<b>Dismounting the inverter .....</b>	<b>26</b>
6.1	Switching AC and DC off .....	27
6.2	Opening the AC plug .....	27
6.3	Removing inverter from mounting plate .....	27
<b>7</b>	<b>Initial commissioning.....</b>	<b>28</b>
7.1	Performing initial commissioning .....	28
7.2	Finishing the initial commissioning.....	28
7.3	Setting the feed-in management.....	29
7.3.1	Connecting energy meter for load/generation measurement.....	29
7.3.2	Selecting an energy meter .....	29
7.3.3	Limiting the dynamic feed-in value.....	29
7.4	Switching DC on .....	29
<b>8</b>	<b>Operation .....</b>	<b>30</b>
8.1	Operating buttons .....	30
8.2	Functions of the operating buttons.....	30
8.3	Menu structure.....	32
8.4	Navigating the menu structure.....	33
<b>9</b>	<b>Faults .....</b>	<b>33</b>
9.1	Event message type .....	33
9.2	Event messages .....	34
<b>10</b>	<b>Maintenance and care.....</b>	<b>41</b>
<b>11</b>	<b>Disposal .....</b>	<b>41</b>
<b>12</b>	<b>Technical data .....</b>	<b>41</b>
12.1	PIKO MP plus 1.5-1, 2.0-1, 2.5-1, 3.0-1 and 3.6-1.....	41
12.2	PIKO MP plus 3.0-2, 3.6-2, 4.6-2 and 5.0-2 * .....	44

## 1 General information

These instructions contain information for the safe use of the inverter and all the information that a specialist needs for setting up, and the operator needs for operating the inverter.

The PIKO MP plus inverters are available in various models for different power classes. The PIKO MP plus X.X-1 inverters are suitable for the connection to one PV generator or one battery. The PIKO MP plus X.X-2 inverters are suitable for the connection to two PV generators or one PV generator and one battery. The connection of a battery to the PIKO MP plus requires the use of the KOSTAL Smart Energy Meter and an activation code Battery. Both is available at our KOSTAL Solar web shop.

The PIKO MP plus inverters are available in the following models:

- PIKO MP plus 1.5-1
- PIKO MP plus 2.0-1
- PIKO MP plus 2.5-1
- PIKO MP plus 3.0-1
- PIKO MP plus 3.0-2
- PIKO MP plus 3.6-1
- PIKO MP plus 3.6-2
- PIKO MP plus 4.6-2
- PIKO MP plus 5.0-2 (available as of Q2/2020)

### 1.1 Accessories

Ask for possible accessories, options, suitable PV generators, and installation material at the installer's or at KOSTAL Solar Electric GmbH.

### 1.2 Documents

Data sheets, country tables, and certificates are available in the download area of the KOSTAL Solar Electric GmbH homepage.

### 1.3 Liability, warranty

The conditions for the device are available for downloading on the KOSTAL Solar Electric GmbH homepage: [www.kostal-solar-electric.com/download](http://www.kostal-solar-electric.com/download) > PIKO MP plus > Model > Country > Warranty.

### 1.4 Contact

In the event of complaints or faults, please contact your local dealer, where you purchased the product, or apply to our Service Hotline. They will assist you in all respects.

Country	Phone	Email
Germany	+49 (0)761 477 44 - 222	service-solar@kostal.com
Switzerland	+41 32 5800 225	service-solar@kostal.com
France, Belgium, Luxembourg	+33 16138 4117	service-solar-fr@kostal.com
Greece	+30 2310 477 555	service-solar-el@kostal.com
Italy	+39 011 97 82 420	service-solar-it@kostal.com
Spain, Portugal	+34 961 824 927	service-solar-es@kostal.com

Country	Phone	Email
Turkey	+90 212 803 06 26	service-solar-tr@kostal.com
China	+86 21 5957 0077-7999	service-solar-cn@kostal.com

## 1.5 Monitoring portal

The "KOSTAL (PIKO) Solar Portal" monitoring portal of KOSTAL Solar Electric GmbH offers online monitoring of the PV system at no charge: [www.kostal-solar-portal.com](http://www.kostal-solar-portal.com)

## 1.6 EU Declaration of Conformity

The products described in this document comply with the applicable European directives. The certificate is available in the download area of our homepage.

## 2 Abbreviations

Abbreviation	Description
AC	Alternating Current
DC	Direct Current
LAN	Local Area Network
MPP	Maximum Power Point
MPP tracker	Regulates the power of the connected module strings to the MPP
PV	Photovoltaics (technology for the conversion of solar energy into electrical energy)
RTU	Remote Terminal Unit
SELV	Safety Extra Low Voltage
TCP/IP	Transmission Control Protocol/Internet Protocol

## 3 Safety

### 3.1 Designated use

The PIKO MP plus inverters are intended for single-phase feed-in and are suitable for indoor and outdoor installation on a wall.

Only use the inverter:

- for grid-connected PV generators.
- for PV generators whose connections are not grounded.
- for solar modules with Class A rating in accordance with IEC 61730 because the inverter does not have any galvanic isolation.
- when the maximum permissible system voltage of the PV generator is higher than the AC grid voltage.
- for the connection of approved batteries



#### NOTE

Only for Italy: information about the particularities for the use in Italy have been added as an appendix to the Italian version of these instructions.

### 3.2 Target group

Unless otherwise noted, the target group for these instructions are specialists and operators. The following persons are considered specialists:

- Persons that have knowledge of the established terms and skills for setting up and operating PV generators.
- Persons that due to their knowledge and experience are able to evaluate the following tasks and recognise possible hazards:
  - Mounting electrical equipment
  - Assembling and connecting data cables
  - Assembling and connecting power supply cables

### 3.3 General safety instructions

- This document must be kept to hand at the site of use of the inverter.  
In case of a change of ownership pass on the document with the inverter.
- This document must have been read and understood in full before installing and using the inverter.
- Do not commission the inverter before a shut-down control or overcurrent protective device has been installed.
- Incorrectly connected components may cause damage to the inverter.
- If one of the following components is damaged, immediately take the inverter out of operation and disconnect it from the grid and the PV generators:
  - Inverter (not functioning, visible damage, smoke, penetration of liquid etc.)
  - Cables
  - PV generators
- Do not switch on the system again until it has been repaired and checked by a suitably qualified and authorised technical specialist.
- Dangerous voltages may be present for up to 10 minutes after disconnecting the inverter from the voltage sources.
- Disconnect inverter from both voltage sources (power grid, PV generator and batteries) prior to any work on the inverter.
- Always carry out the measures described in this document in the specified sequence.
- Do not change nor remove any factory-applied labels on the inverter.
- Do not open the inverter. Danger to life! Opening the inverter will also void any warranty.
- Do not cover the inverter.
- Keep children away from the inverter.
- Follow the instructions of manufacturers of the connected components.
- Follow the general and national safety and accident prevention regulations.







The inverter cannot cause a DC residual current due to its design.



## 3.4 Labels and symbols

### 3.4.1 Safety marks

The following safety marks are used on the inverter and in these instructions:

Warning sign	Nature of the danger
	Warning of hazardous voltage
	Warning of hazardous area
	Warning of hot surface
	Disposal information (separate collection of electrical and electronic equipment)

### 3.4.2 Keywords

The following keywords are used in these instructions:

Keyword	Meaning
<b>DANGER</b>	Indicates a hazardous situation which, if not avoided, leads to death or serious injuries.
<b>WARNING</b>	Indicates a potentially hazardous situation which, if not avoided, may lead to death or serious injuries.
<b>NOTE</b>	Indicates a potentially hazardous situation which, if not avoided, may lead to damage to property and/or the environment.

### 3.4.3 Signs, labels and safety marks on the device

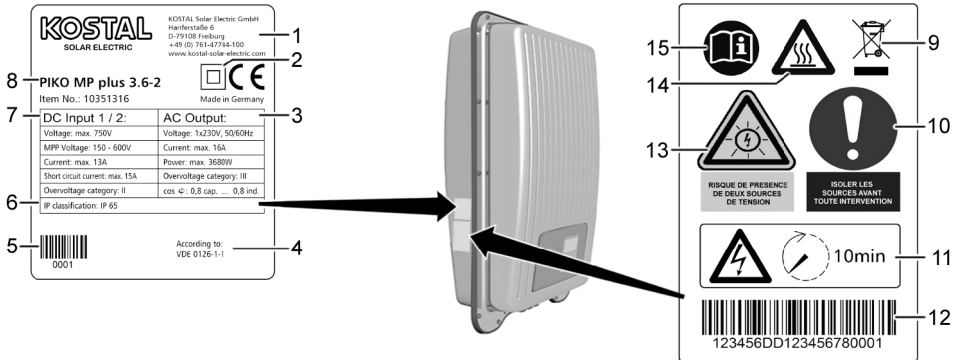

- 1 Manufacturer address
- 2 "Protection Class II" symbol
- 3 Technical data of the AC output
- 4 Standard for grid monitoring
- 5 Barcode (for internal purposes)
- 6 Degree of protection
- 7 Technical data of the DC input
- 8 Item number and product name
- 9 Disposal information (separate collection of electrical and electronic equipment)
- 10 Request to disconnect the power sources prior to any intervention
- 11 Note on presence of voltage after switching off the inverter
- 12 Serial number (barcode and plain text)
- 13 Warning of voltage (two voltage sources)
- 14 Warning of hot surface
- 15 Follow the instructions

## 4 Description

### 4.1 Scope of delivery



- 1 Inverter
- 2 Mounting plate
- 3 AC plug
- 4 DC plug (one pair per DC connection)
- 5 Sealing cap (3 units)
- 6 Installation and operating instructions

### 4.2 Structure of the device

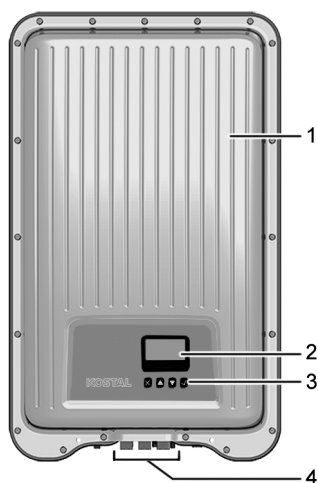

- 1 Case
- 2 Display (monochrome, 128 x 64 pixels)
- 3 Operating buttons (for function refer to chapter 8)
- 4 Connections

### 4.3 Exemplary connection

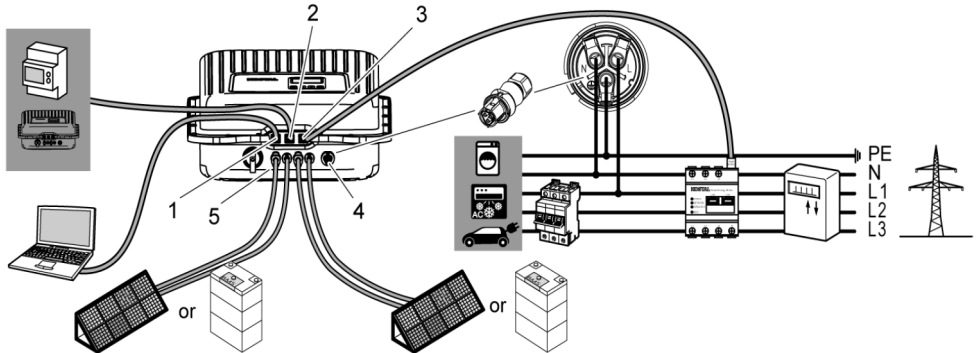

PIKO MP plus X.X-1: DC1 - PV / Bat PIKO MP plus X.X-2: DC2 - PV / Bat  
 PIKO MP plus X.X-2: DC1 - PV

- 1 Connection of evaluation system via LAN
- 2 Data logger / other inverters via COM1
- 3 Connection of energy meter to the mains connection via COM2
- 4 Mains connection
- 5 Connection PV generator or battery\*\*  
 PIKO MP plus X.X-1: DC1 connection PV or battery  
 PIKO MP plus X.X-2: DC1 connection PV, DC2 connection PV or battery

### 4.4 Connections, communication, and DC/AC

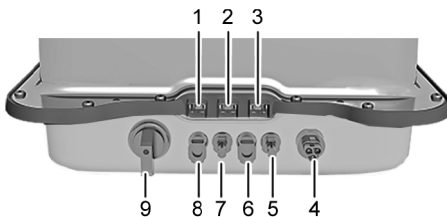

- 1 LAN (RJ45 socket)
- 2 COM1 (RJ45 socket for the connection of e.g. external data logger via RS485)
- 3 COM2 (RJ45 socket for the connection of e.g. external Modbus RTU energy meter)
- 4 AC connection
- 5 DC2 connection '-' terminal\*  
(Connection PV generator or battery\*\*)
- 6 DC2 connection '+' terminal\*  
(Connection PV generator or battery\*\*)
- 7 DC2 connection '-' terminal  
(Connection PV generator or battery\*\*)
- 8 DC2 connection '+' terminal  
(Connection PV generator or battery\*\*)
- 9 DC disconnect (interrupts the plus and minus inputs simultaneously)

\* Only for PIKO MP plus X.X-2 (with second DC connection)

\*\* Battery connection is possible with PIKO MP plus X.X-1 to the DC1 connection, and with the PIKO MP plus X.X-2 to the DC2 connection. An activation code Battery and a KOSTAL Smart Energy Meter are required for the connection. Both is available at the KOSTAL Solar web shop.

## 4.5 Connection cables

Pin assignment of alternative RS485 data connecting cable for external data loggers or for the connection of further inverters.

Device	Signal	Inverter
<b>Connection</b>	<b>↓</b>	<b>COM1/COM2</b>
Contact	Data A	1
	Data B	2
	Ground	8

The connection of the external energy meter KOSTAL Smart Energy Meter (KSEM) is described in the operating instructions "KOSTAL Smart Energy Meter". The connection of other approved external energy meters is described in the operating instructions "PIKO MP plus Energiezähler / Energy meters". Both documents can be found in our download area.

Connection KOSTAL Smart Energy Meter for load/generation measurement:

Device	Signal	Inverter	KSEM
<b>Connection</b>	<b>↓</b>	<b>COM2</b>	<b>RS485 (B)</b>
Contact	Data A	6	3
	Data B	7	4
	Ground	8	2

Connection KOSTAL Smart Energy Meter for battery control:

Device	Signal	Inverter	KSEM
<b>Connection</b>	<b>↓</b>	<b>COM1</b>	<b>RS485 (B)</b>
Contact	Data A	1	3
	Data B	2	4
	Ground	8	2



### NOTE

Contact 1 of the RJ12 socket supplies 24 V DC!

The RS485 input of the inverter may be damaged.

- ▶ Never connect the alternative data connecting cable to contact 1.

## 4.6 Display

The display shows the menus of the inverter.

The backlight of the display is switched on by pressing any button. The operating states of the inverter are shown as follows:

Display	Meaning
	The inverter is processing large data volumes. It is not possible to enter user data
Backlight flashing red with event message	Fault

## 4.7 Cooling

The inverter may heat up during operation. This is a normal operating characteristic. A fan disperses the waste heat inside the closed case evenly onto the case surface. Cooling fins allow the heat to dissipate to the surrounding.

## 4.8 Grid monitoring

The grid monitoring in the device permanently monitors the grid parameters of the public grid. If the grid monitoring detects a deviation of the grid parameters from the statutory requirements, the device switches off automatically. When the public grid meets the statutory requirements again, the device switches on again automatically.

## 4.9 Data communication

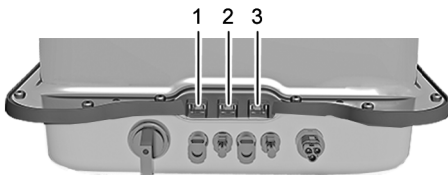

- "LAN" connection (1) (Ethernet for TCP/IP network) for the communication with a central data server.
- "COM1" connection (2) (RS485 bus) for the communication with external devices, e.g. with a data logger or (in the battery mode) with the KOSTAL Smart Energy Meter for battery control.
- "COM2" connection (3) (Modbus RTU) for the communication with e.g. an external energy meter. The separate instructions for energy meters can be found on the KOSTAL Solar Electric GmbH homepage in the download area for the product.

### 4.9.1 "COM1" and "COM2"

The inverter can communicate with other device via the "COM1" and "COM2" connections. Requirements for the communication:

- Both ends of the data connection are terminated.
- RJ45 standard cables or alternative data connecting cables are used as bus cables.

For further information about connecting further master devices and further inverters refer to the document "Technical Information" in the download area on the KOSTAL Solar Electric GmbH homepage.

#### "COM2"

The inverter is able to communicate with energy meters (Modbus RTU) via the "COM2" connection. To do this, the energy meter must meet the following requirements:

- The energy meter has been programmed in the inverter.
- The energy meter measures the draw from the grid in positive direction (refer to instructions Energy meter in the download area on the KOSTAL Solar Electric GmbH homepage).

### 4.9.2 Modbus RTU data connecting cable



#### NOTE

Voltage may cause property damage.

- ▶ Only have specialists manufacture the alternative data connecting cable.
- ▶ Only use suitable outdoor patch cables for outdoor installations.

Use a RJ45 standard cable or a CAT5 patch cable as data connecting cable. For further information about the plug connection of the Modbus RTU data connecting cable refer to the document "Technical Information" or "Energy meters" in the download area on the KOSTAL Solar Electric GmbH homepage.

### 4.9.3 Alternative RS485 data connecting cable

Use a CAT 5 cable for the alternative data connecting cable in the case of long data connecting distances.

For further information about the data connecting cable, the RS485 termination, and the pin assignment of the alternative RS485 data connecting cable refer to the document "Technical Information" in the download area on the KOSTAL Solar Electric GmbH homepage.

### 4.9.4 LAN



Automatic start of the transmission of unencrypted data.

After establishing the network connection, the inverter automatically starts data transmission to the server. If automatic transmission is not wanted:

▶ Remove network cable.

Or:

▶ Deactivate data transmission in "Settings" > "Network".

Via the "LAN" connection, the inverter can send yield data and event messages to the server of a web portal. The web portal allows the graphical representation of the yield data. With the monitoring portal "KOSTAL (PIKO) Solar Portal", online monitoring of PV systems is easy and comfortable.



▶ In the menu "Settings" > "Network", the operator can enter network parameters in further submenu masks; refer to the document "Technical Information" in the download area on the KOSTAL Solar Electric GmbH homepage.

### 4.10 Connection peculiarities

When "Italy" has been set in the country selection, the "COM1" or "COM2" connection must be wired in accordance with the CEI 0-21 standard. For a detailed description of this refer to the appendix (only in the Italian version of these instructions) or the document "Technical Information" in the download area on the KOSTAL Solar Electric GmbH homepage.

### 4.11 Data display

The following data are shown on the display:

- voltage and current generated by the PV generator
- power and current fed into the public grid
- current voltage and frequency of the public grid
- generated energy yields on a daily, monthly and annual basis
- current error states and notes
- information about the version of the device
- in the battery mode, the SOC, the battery voltage, and the charge and discharge current



### 4.11.1 Data storage

In the internal memory (EEPROM), event messages and energy yields are stored with the date. The energy yields are stored for the specified period.

Energy yield	Storage resolution/period
10-minute values	31 days
Daily values	13 months
Monthly values	30 years
Annual values	30 years
Total yield	Permanent

## 5 Installation

### 5.1 Safety instructions for assembly and installation



#### **DANGER**

##### Voltage

Under solar radiation, the PV generators and cables may be energised. There is the risk of death due electrocution and electric discharge.

- ▶ Disconnect the DC and AC connections from the power source prior to any work on the inverter:
  - Switch off all AC line circuit breakers and secure them against being switched on again.
  - Set the DC disconnecter on the inverter to position '0' and secure it against being switched on again.
  - Disconnect the plug connectors of the DC cables (follow the instructions of the manufacturer).
  - Disconnect AC plug from the inverter: press locking hook on the AC plug slightly and remove AC plug.
- ▶ Only have specialists carry out any installation work.
- ▶ Only connect the cables to the inverter when it is requested by the instructions.
- ▶ Only connect SELV circuits to the RJ45 socket.
- ▶ Maintain access to the shut-down control free at all times.
- ▶ Only have trained qualified personnel carry out the installation and commissioning.

**NOTE**

Improper installation may cause performance reduction or damages on the inverter.

- ▶ Ensure that the installation site meets the following requirements:
  - The mounting surface and immediate surrounding must be: permanently fixed, vertical, level, of low flammability, and not subject to constant vibration.
  - The ambient conditions are within the permissible range (refer to Technical data).
  - Open spaces are provided for around the device (above and underneath  $\geq 200$  mm, to the sides and in front  $\geq 60$  mm).
- ▶ Do not install the device in stables where animals are kept.
- ▶ Avoid exposure to direct sunlight of the device.
- ▶ Ensure that the display can be easily read on the installed device.



Data transmitted via a public network are not protected from being accessed by third parties.

Data transmission via a public network may cause additional costs.

- ▶ Obtain information on costs possibly involved prior to the use of a public network.
- ▶ Use a public network at your own risk.

- Lay the cables such that the connection cannot come loose accidentally.
- Ensure that the fire safety measures of the building are not impaired when routing cables for the device.
- Make sure that no inflammable gases are present.
- Observe all applicable installation regulations and standards, national laws and connection values specified by the regional power supply company.
- Observe the connection ratings specified on the type plate.
- Do not connect the DC cables to ground potential.  
The DC inputs and the AC output are not galvanically isolated from each other.

## 5.2 Mounting the inverter

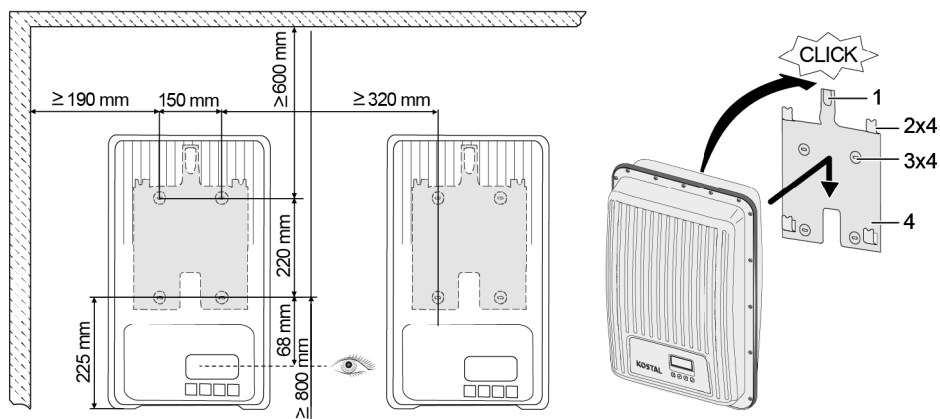

1. Fasten the mounting plate (4) to the mounting surface with 4 screws (3). The locking plate (1) points upwards.
2. Place inverter on the mounting plate.
3. Hook the 4 locating pins on the back of the inverter into the retaining tabs (2) of the mounting plate.
4. Press inverter against the mounting plate. The detent on the back of the inverter engages audibly in the locking plate (1).

## 5.3 Preparing AC connection



### DANGER

Voltage

There is a risk of death by electrocution.

- ▶ Follow the safety instructions and warning notices in chapter 5.1.
- ▶ Never disconnect nor connect the plug connection while the AC connection is live.
- ▶ Install the circuit breaker prior to any work on the AC connection.

### 5.3.1 Residual current circuit breaker

If the local installation specifications prescribe the installation of an external residual current circuit breaker, install a residual current circuit breaker. In accordance with IEC 62109-1, a type A residual current circuit breaker is adequate.

### 5.3.2 AC cables

#### Suitable cables

- UL AWM Style 21098, size No. AWG 14
- UL AWM Style 2464, size No. AWG 16-22

Inverter	Cable cross section AC cable	Power loss (with 10 m cable length)	Circuit breaker
PIKO MP plus 1.5-1	1.5 mm <sup>2</sup>	10 W	B16
	2.5 mm <sup>2</sup>	6 W	
	4.0 mm <sup>2</sup>	4 W	
PIKO MP plus 2.0-1	1.5 mm <sup>2</sup>	18 W	B16
	2.5 mm <sup>2</sup>	11 W	
	4.0 mm <sup>2</sup>	6 W	
PIKO MP plus 2.5-1	2.5 mm <sup>2</sup>	16 W	B16
	4.0 mm <sup>2</sup>	11 W	
PIKO MP plus 3.0-1	2.5 mm <sup>2</sup>	25 W	B16 or B25
PIKO MP plus 3.0-2	4.0 mm <sup>2</sup>	15 W	
PIKO MP plus 3.6-1	2.5 mm <sup>2</sup>	35 W	B25
PIKO MP plus 3.6-2	4.0 mm <sup>2</sup>	23 W	
PIKO MP plus 4.6-2	2.5 mm <sup>2</sup>	56 W	B25
	4.0 mm <sup>2</sup>	35 W	
PIKO MP plus 5.0-2	2.5 mm <sup>2</sup>	64 W	B25
	4.0 mm <sup>2</sup>	40 W	

### 5.3.3 Assembling the AC plug



#### NOTE

If the instructions of the plug manufacturer are not followed when connecting the AC plug, the cable and the device may be damaged.

- ▶ Protect plug from bending loads.
- ▶ Do not use plug connector for interruption of current.

### 5.3.3.1 Preparing cables

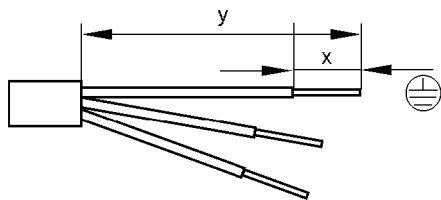

	Single connection				Double connection	
	Ø 6....14		Ø 13....18		PE	N, L
Y	30	25	42	37	45	40
X	8					

### 5.3.3.2 Fitting cable to AC plug



#### NOTE

Plug parts not assigned affect the IP rating of the degree of protection.  
Always seal plugs not in use with protective caps.

#### 220 V to 240 V grid voltage

Connect conductors N, L, and PE on the AC plug in 1-phase grid with 220 V to 240 V grid voltage.

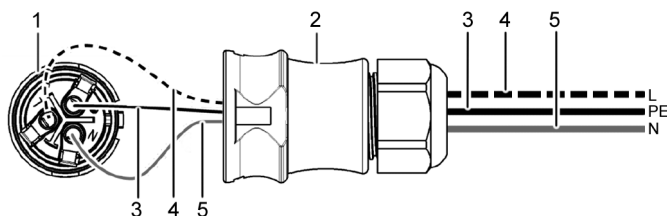

- 1 AC plug, inner part
- 2 AC plug, housing part
- 3 PE conductor
- 4 L conductor
- 5 N conductor

## 100 V to 127 V grid voltage



### DANGER

#### Voltage

There is a risk of death by electrocution when connecting the phases L1, L2, or L3 to PE or N.

- ▶ Follow the safety instructions and warning notices in chapter 5.1.

The structure of 100 V to 127 V grid voltages differs from that of 220 V to 240 V grid voltages as it is not a 1-phase but a 2 or 3-phase grid.

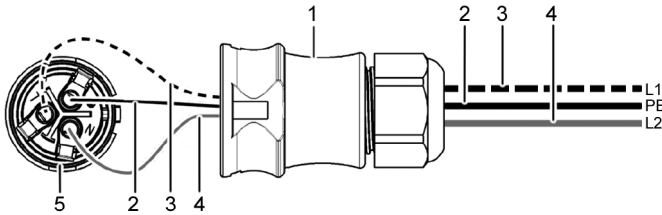

- 1 AC plug, housing part
- 2 PE connection
- 3 L1 connection (outer conductor)
- 4 L2 connection (outer conductor)
- 5 AC plug, inner part

### Connection to 2-phase grid

1. Connect the N and L connection of the AC plug (5) between the L1 (3) and L2 (4) outer conductors of the grid cable.
2. Connect PE cable (2) to PE connection on the AC plug.

### Connection to 3-phase grid

In the 3-phase grid, there are 3 outer conductors in the cable:

1. Connect N and L connections of the AC plug between any 2 outer conductors (between L1 and L2, or L1 and L3, or L2 and L3).
2. Connect PE cable to PE connection on the AC plug.

### Voltage distribution in the 2 and 3-phase grid

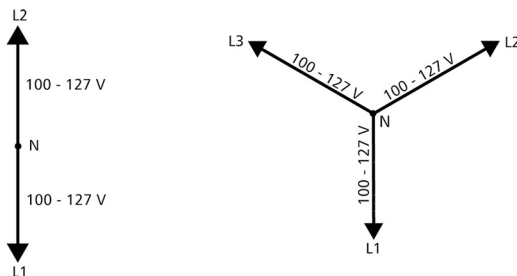

The voltage in 2 and 3-phase grids is the same in every outer conductor: 100 V to 127 V.

## Assembly instruction for AC plug

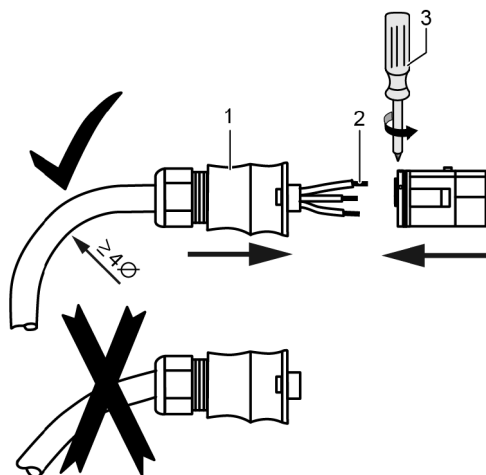

1. Guide cable through the plug housing. Slide plug housing (1) onto the cable.
2. Introduce wire ends (2) into the plug. Ensure that the bending radius of the cables is large enough (at least 4 times the cable diameter).
3. Using a screwdriver (Pozidriv PZ1) (3), secure wire ends with clamping screws. Tightening torque: 0.8 to 1 Nm. Ensure that the clamping connection holds.
4. Slide plug housing onto the plug and tighten until a click sound is heard.

## 5.4 Preparing DC connection



### DANGER

Voltage

There is a risk of death by electrocution.

- ▶ Follow the safety instructions and warning notices in chapter 5.1.
- ▶ Use the SUNCLIX plug connectors (DC plugs) included in the scope of delivery to ensure the specified degree of protection.



### NOTE

If the DC plugs are not connected correctly to the DC cable, there is a risk of short circuit. The inverter and modules may be damaged.

- ▶ Connect counterparts to the DC connections to the DC cable ensuring correct polarity.

**NOTE**

Soiled, displaced, or damaged seals impair the strain relief and the impermeability.

- ▶ Do not soil, shift, nor damage the seals during DC plug assembly.

**Fitting cable to DC plug**

1. Strip 15 mm of cable end of cable (1).
2. Release spring (2) upwards.
3. Introduce stripped cable end into the DC plug until the cable end becomes visible underneath the spring (2).
4. Press spring (2) against the stripped cable end until it engages audibly. Ensure that the cable end is securely fastened.
5. Slide union nut (4) onto inset (3) of the DC plug.
6. Hold inset with a size 16 wrench and tighten the union nut (4) with a wrench, applying a tightening torque of 2 Nm.

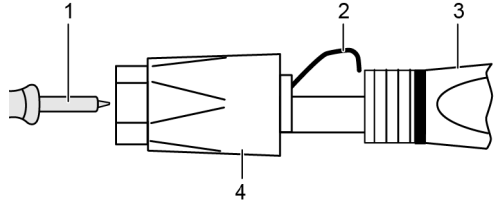
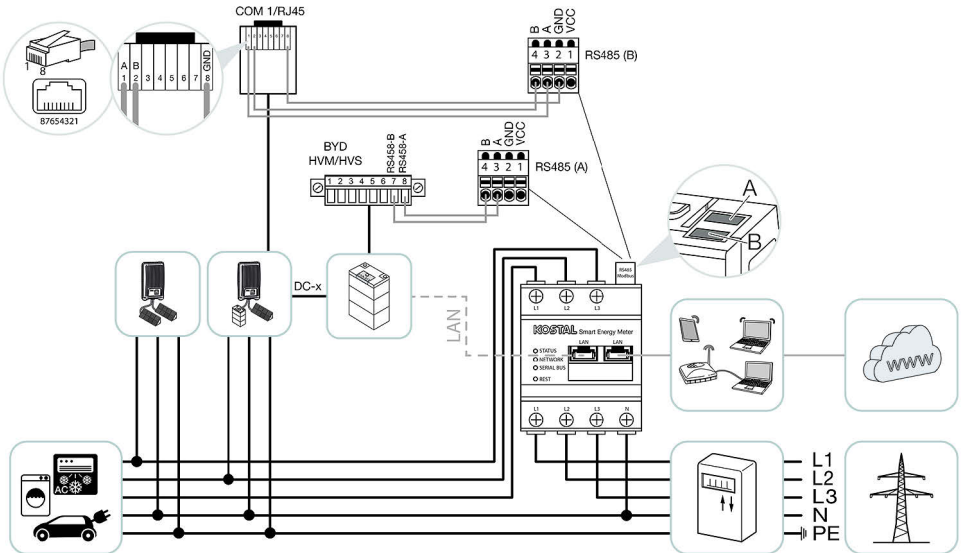
**5.5 Connecting battery to the inverter**

Depending on the type of device, a battery can be connected to the DC1 or DC2 connection on the PIKO MP plus. In addition to the battery, this requires a KOSTAL Smart Energy Meter and also an activation code Battery, which must be entered in the KOSTAL Smart Energy Meter.

The communication and control of the battery and the inverter (charging/discharging) takes place via the KOSTAL Smart Energy Meter. Therefore, both device must be set up in the KOSTAL Smart Energy Meter. Information about this can be found in the operating instructions of the KOSTAL Smart Energy Meter.



In the PIKO MP plus, the DC connection to which the battery is connected to must be selected in the menu "Settings" > "Service" > "Input". Selecting the energy meter in the PIKO MP plus and the installation position (only one grid connection point is admitted) is not required.

Both devices (PIKO MP plus and battery) must be entered and configured in the KOSTAL Smart Energy Meter.

The battery can be connected to the following DC connections:

PIKO MP plus	DC1	DC2	Battery
PIKO MP plus X.X-1	X	--	X
PIKO MP plus X.X-2	--	X	X



A list of the approved batteries for the PIKO MP plus can be found in the download area for the product on our homepage [www.kostal-solar-portal.com](http://www.kostal-solar-portal.com).



### **DANGER**

Voltage

There is a risk of death by electrocution.

- ▶ Follow the safety instructions and warning notices for battery and energy meter.
- ▶ The communication cable may only be connected if all devices are free of voltage. Follow the operating instructions of the manufacturers.

1. Disconnect in-house grid and battery storage from voltage.
2. Lay the communication cable from the inverter and battery storage to the KOSTAL Smart Energy Meter and connect it to the intended interface on the KOSTAL Smart Energy Meter. The installation and configuration are described in the operating instructions for the KOSTAL Smart Energy Meter, refer to [www.kostal-solar-electric.com/download](http://www.kostal-solar-electric.com/download) > Accessories > KOSTAL Smart Energy Meter > Country > Operating instructions.
3. Connect DC cables of the battery to the PIKO MP plus.
4. After installing the inverter, change DC connection to which the battery is connected to Battery in the inverter, in the menu "Settings" > "Service" > "Input" > "DCx".
5. Check the RS485 address of the inverter for later setup in the KOSTAL Smart Energy Meter (in the menu "Settings" > "RS485 address").

## 5.6 Connecting inverter and switching AC on



### DANGER

Voltage

There is a risk of death by electrocution.

- ▶ Follow the safety instructions and warning notices in chapter 5.1.



DC and AC cables may interfere with data transmission.

- ▶ Keep a distance of 200 mm between the data connecting cables (RS485/Ethernet) and the DC/AC cables.



### NOTE

If sealing caps are missing, moisture may get into the inverter.

- ▶ Seal vacant RJ45 sockets with sealing caps.

1. If required, establish the data connection:
  - Connect inverters (mater device and further connected inverters) with data connecting cable(s).
2. Seal vacant RJ45 sockets with sealing caps.
3. Press DC plug firmly into the DC connection in the inverter until it engages audibly.
4. Insert AC plug into the AC connection in the inverter until it engages audibly.
5. Switch on the AC circuit breaker.
6. The display shows the start page of initial commissioning.

## 6 Dismounting the inverter

The safety instruction from chapter 5 apply.



### DANGER

Voltage can be present at the DC-connection for up to 10 minutes after switching off the DC circuit breaker.

There is a risk of death by electrocution.

- ▶ Wait 10 minutes after switching off the DC disconnecter.



### DANGER

The PV generator carries voltage when there is solar radiation.

There is a risk of death by electrocution.

- ▶ Only have specialists carry out any work on the DC connection.

## 6.1 Switching AC and DC off

1. Turn DC disconnecter on the inverter to position "0".
2. Switch the AC circuit breaker off.

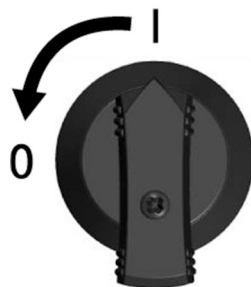
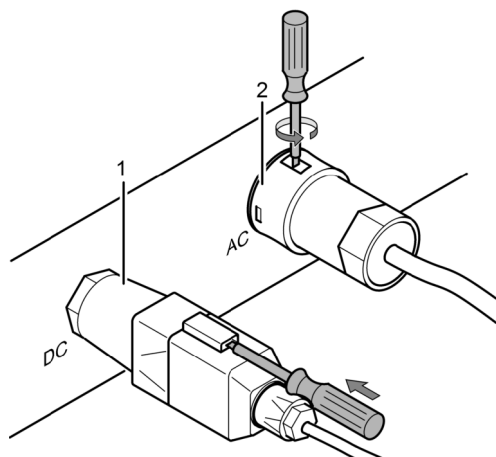

3. Disconnect DC connection (1) from inverter: insert screwdriver into unlocking opening, keep screwdriver inserted, and pull plug out.
4. Disconnect AC plug (2) from inverter: slightly press in and rotate the locking hook with a suitable tool, e.g. a screwdriver, and pull AC plug out.
5. Ensure that none of the AC plug poles carries voltage with the help of a suitable voltage tester (do not use a phase testing probe).

## 6.2 Opening the AC plug

1. Open the rear cable gland.
2. Simultaneously press in the locking hooks on the left and on the right of the plug housing with a suitable tool.
3. Remove the upper part of the housing from the contacting part.

## 6.3 Removing inverter from mounting plate

1. Press locking plate (3) towards the wall and hold it there.
2. Push inverter upwards until the detent (2) can no longer snap in.
3. Release the locking plate.
4. Hold inverter by the edge (1) with both hands and lift it off upwards. The locating pins (4) must separate from the retaining tabs of the mounting plate.
5. Remove inverter from mounting plate.
6. Unscrew the fastening screws of the mounting plate.
7. Remove mounting plate.

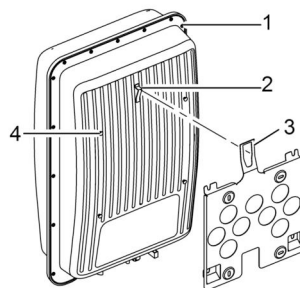

## 7 Initial commissioning

### 7.1 Performing initial commissioning

After installing and switching on the inverter, the dialogue for initial commissioning starts automatically. During initial commissioning, the user is guided via a checklist on the display.

If the initial commissioning is not completed, the dialogue for initial commissioning will start again after switching on the inverter.



Not until all the checkboxes in the checklist have been marked and the "Finish" menu is closed, will the initial commissioning be concluded.

During initial commissioning, the operator is guided through the menus "Display language", "Date", "Time", "Country", and "Reactive power characteristic curve" (only when prescribed for the selected country).

The settings in the menus of the initial commissioning are performed via the operating buttons (for a comprehensive description of the function of the operating buttons, refer to chapter 8).

### 7.2 Finishing the initial commissioning

By selecting "Finish" in the checklist, the successful completion of the initial commissioning is confirmed. If any settings have not been processed completely, the message "Settings are incomplete" appears. In this case:

1. Press "✓". The checklist is displayed again.
2. Process the open items and finish the processing.

When all settings have been processed, a dialogue stating "Are all settings correct?" is displayed. In this case:

1. If any settings have to be corrected, select the corresponding menu in the checklist and correct the settings.
2. If all the settings are correct: press "✓" longer. The inverter is restarted and synchronises itself with the grid.

After finishing the initial commissioning, you can set the feed-in management and switch DC on (refer to section 7.4).



For any information about particular settings (e.g. incorrect entries or missing countries in the country setting) refer to the document "Technical Information" in the download area on the KOSTAL Solar Electric GmbH homepage.

### 7.3 Setting the feed-in management

Depending on the country, the active power on the connection point must be limited to a maximum value. The following products are suitable for implementing this legal requirement:

- KOSTAL Smart Energy Meter
- Other approved energy meters (refer to the document "PIKO MP plus Energiezähler / Energy meters", which can be found in the download area for the product).

In the "Energy management" menu item, the mode, the feed-in rules, and the meter type are set.



For a detailed description of the settings of the feed-in management refer to the document "Technical Information" in the download area on the KOSTAL Solar Electric GmbH homepage.

#### 7.3.1 Connecting energy meter for load/generation measurement

An energy meter can be connected to the inverter via the Modbus RTU interface "COM2" (refer to section 4.9.1).

In the "Mode" menu, the "Energy meter" function can be switched on or off.

In the menu "Mode" > "Configuration" > "Meter type" > "Meter position" (mains connection point or household consumption), you can select the installation position of the meter. Further information can be found in the instructions for the KOSTAL Smart Energy Meter or the PIKO MP plus energy meter.

#### 7.3.2 Selecting an energy meter

The inverter can only communicate with the programmed energy meters.

#### 7.3.3 Limiting the dynamic feed-in value

The feed-in value (country specific) can be entered from 0 W upwards in 10 W increments.

### 7.4 Switching DC on

Switching on the DC disconnecter on the inverter finishes the installation of the inverter. After approx. 2 minutes, the display can show the fed-in power (provided that there is solar radiation).

If a battery is used: first, switch on battery and wait until the battery has started up.

1. Turn DC disconnecter on the inverter to position 'I'.

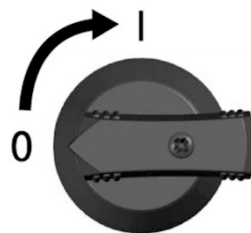

## 8 Operation

### 8.1 Operating buttons

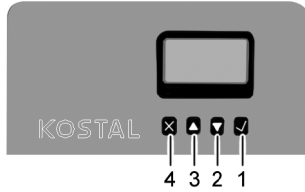

- 1 ✓ (SET)
- 2 ▽
- 3 △
- 4 X (ESC)

### 8.2 Functions of the operating buttons

Button	Action	Function	
		Normal operation	Commissioning
X	Press briefly	<ul style="list-style-type: none"> <li>- Jumps 1 menu level up</li> <li>- Discards changes</li> </ul>	Jumps 1 step back
	Press longer (≥ 1 second)	Jumps to the start image	Jumps to the start of the guided operation
△	Press briefly	<ul style="list-style-type: none"> <li>- Moves the selection bar or the display content upwards</li> <li>- Moves the selection bar 1 position to the left when setting numeric values</li> <li>- Increases the setting value by 1 step</li> </ul>	
		Browses in menu structure	-
	Press longer (≥ 1 second)	Triggers a repetition of the command. The repetition rate increases when pressing for a longer period	

Button	Action	Function	
		Normal operation	Commissioning
▽	Press briefly	<ul style="list-style-type: none"> <li>- Moves the selection bar or the display content downwards</li> <li>- Moves the selection bar 1 position to the right when setting numeric values</li> <li>- Decreases the setting values by 1 step</li> </ul>	
		Browses in menu structure	-
	Press longer (≥ 1 second)	Triggers a repetition of the command. The repetition rate increases when pressing for a longer period	
✓	Press briefly	<ul style="list-style-type: none"> <li>- Jumps down by 1 menu level</li> <li>- Jumps to the diagram view in certain menus</li> </ul>	-
		<ul style="list-style-type: none"> <li>- A selected value starts flashing and can be changed</li> <li>- Accepts any entered changes</li> <li>- Changes the state of a control element (check box / radio button)</li> </ul>	
	Press longer (≥ 1 second)	Answers a query dialogue with Yes	Navigates 1 step forward

### 8.3 Menu structure

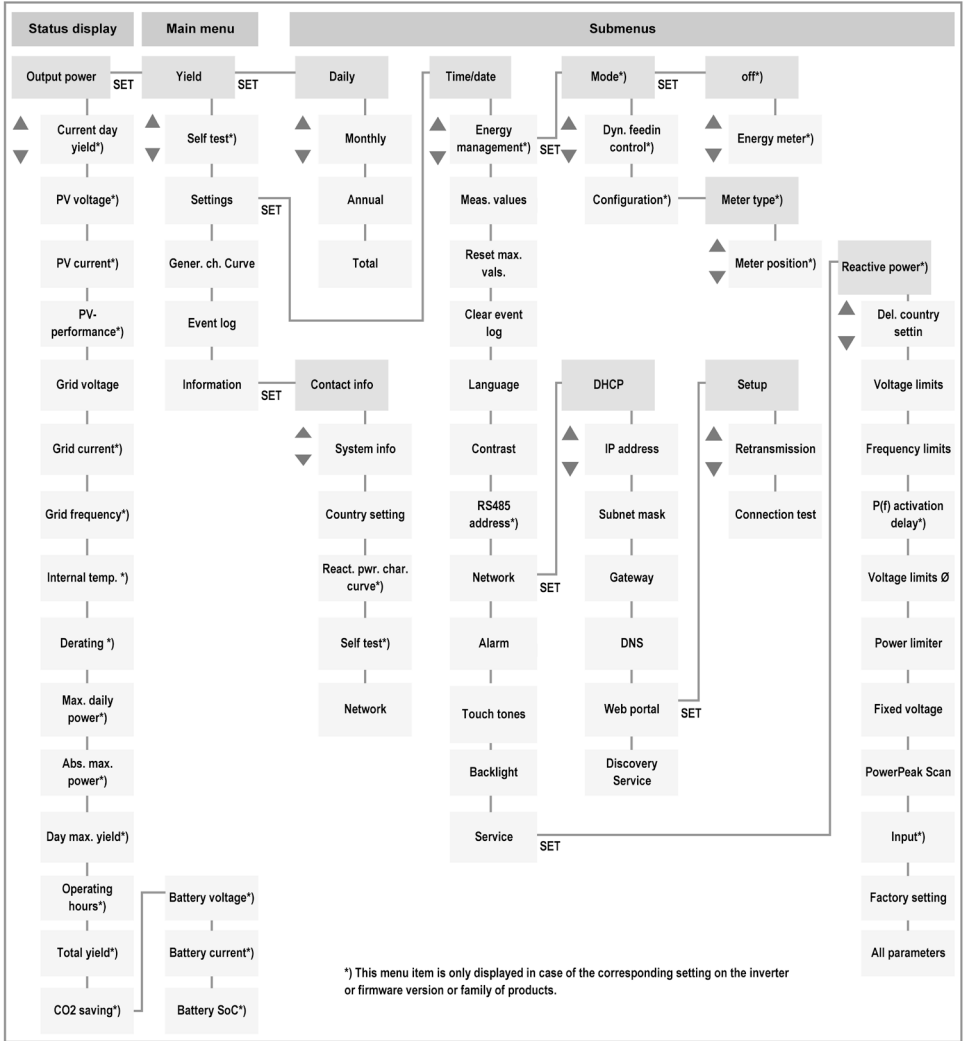

Due to further technical development, changes of the menu structure are possible after delivery of this document. The current version of the menu structure is available in the download area on the KOSTAL Solar Electric GmbH homepage.



## 8.4 Navigating the menu structure

- To go from one "Output power" status display to the other status displays: scroll through the status displays with the " $\triangle \nabla$ " operating buttons.
- To go from the "Output power" status display to the main menu: press " $\checkmark$ ".
- To go to the other menu items within the main menu: scroll through the menu with the " $\triangle \nabla$ " operating buttons.
- To go from a menu item to a submenu: press " $\checkmark$ ".
- To go to other menu items within a submenu: scroll through the submenu with the " $\triangle \nabla$ " operating buttons.
- To return from any menu to the "Output power" status display: press and hold "X" for 1 second.



For a detailed description of the individual menu items refer to the document "Technical Information" in the download area on the KOSTAL Solar Electric GmbH homepage.

## 9 Faults

Faults are indicated by a red background that is flashing. An event message is also displayed at the same time.

Event messages contain the following information:

- Event message type
- Date/time of the event message
- Note on the status of the event:  
*Active* = fault is still present  
*Date/time* = fault was eliminated at the indicated time
- Cause of the fault
- Consecutive number / total number in the list of events
- Acknowledged / not acknowledged fault

Events are acknowledged by pressing the "X" or " $\triangle \nabla$ " operating buttons. The fault, however, persists until the cause for the fault has been remedied.

### 9.1 Event message type



#### Information

The inverter has detected an error which does not impair feed-in. There is no need for the user to intervene.



#### Warning

The inverter has detected an error which may cause reduced yields. It is recommended to eliminate the cause of error.



#### Error

The inverter has detected a serious error. The inverter does not feed in as long as the error is present.

Inform the installer.









## 9.2 Event messages

The following table contains examples for event messages and their elimination.









Event message	Description	Type
<i>Battery charge over current (7559)</i>	<p>Battery error due to a too high charging current. Battery charging is stopped.</p> <ul style="list-style-type: none"> <li>- Charging should be possible again after 5 min. If this error is permanently present, contact hotline.</li> </ul>	⊗
<i>Battery discharge over current (7561)</i>	<p>Battery error due to a too high discharging current. Battery discharging is stopped.</p> <ul style="list-style-type: none"> <li>- Discharging should be possible again after 5 min. If this error is permanently present, contact hotline.</li> </ul>	⊗
<i>Battery input error detected</i>	<p>Detecting the correct connection of the battery has failed. Possibly, the communication between battery and energy management has been interrupted, a condition which causes battery switch-off.</p> <ul style="list-style-type: none"> <li>- Check if the battery has been connected and set correctly.</li> <li>- In case everything has been connected and set correctly: perform restart of the inverter and the battery. First, start battery and then the inverter. Prior to switching on the DC power of the inverter, perform putting into operation in the KSEM.</li> </ul>	⊗
<i>Battery over voltage (7551)</i>	<p>Internal battery error due to overvoltage. Charging and discharging the battery is stopped.</p> <ul style="list-style-type: none"> <li>- This error is corrected by the normal household consumption. If this error is permanently present, contact hotline.</li> </ul>	⊗
<i>Battery temperature high (7555)</i>	<p>Battery error due to temperature too high. Charging and discharging the battery is stopped.</p> <p>As soon as the battery is in the normal temperature range, the error is corrected.</p>	⊗
<i>Battery temperature low (7557)</i>	<p>Battery error due to temperature too low. Charging and discharging the battery is stopped.</p> <p>As soon as the battery is in the normal temperature range, the error is corrected.</p>	⊗

Event message	Description	Type
<i>Battery under voltage (7553)</i>	Internal battery error due to undervoltage. Charging and discharging the battery is stopped. - If this error is permanently present, contact hotline.	⊗
<i>Battery voltage error</i>	The battery voltage detected by the inverter is outside the permitted operating voltage range of the battery. Possibly, the communication between battery and energy management has been interrupted, a condition which causes battery switch-off. - Check if the communication cable between battery and energy management has been installed correctly and if the battery has been set on the correct DC input. - In case everything has been connected and set correctly: perform restart of the inverter and the battery. First, start battery and then the inverter. Prior to switching on the DC power of the inverter, perform putting into operation in the KSEM.	⊗
<i>Boost converter defect</i>	The boost converter is defective; the inverter does not feed into the grid or feeds into the grid with reduced power. - Inform the installer.	⊗
<i>Boost converter has wrong HW version</i>	The inverter cannot detect an internal component, or the component does not match the other components. The inverter does not feed into the grid. - Inform the installer.	⊗
<i>Boost converter malfunction</i>	An internal component of the inverter is defective. The inverter does not feed into the grid or feeds into the grid with reduced power. - Inform the installer.	⊗
<i>Boost converter not connected</i>	The connection of the internal components is disrupted. The inverter does not feed into the grid. - Inform the installer.	⊗
<i>Boost converter not recognised</i>	- Inform the installer.	⊗
<i>Country parameters invalid</i>	The inverter cannot feed into the grid because it does not have valid parameters. - Inform the installer.	⊗

Event message	Description	Type
<i>Data transfer failed</i>	<p>A setting has failed, e.g. during initial commissioning, because it has not been transmitted correctly.</p> <ul style="list-style-type: none"> <li>- Perform the setting again.</li> <li>- If this error persists, inform the installer.</li> </ul>	⊗
<i>Device overheated</i>	<p>Despite power reduction, the maximum permissible temperature has been exceeded. The inverter does not feed into the grid until the permissible temperature range has been reached.</p> <ul style="list-style-type: none"> <li>- Check mounting conditions.</li> <li>- If the error occurs repeatedly, inform the installer.</li> </ul>	⊗
<i>Failure - Battery Cell Imbalance (7564)</i>	<p>Internal battery error</p> <ul style="list-style-type: none"> <li>- If this error is permanently present, contact hotline.</li> </ul>	⊗
<i>Failure - Battery communication (7999)</i>	<p>Battery communication error</p> <p>The RS485 connection between KOSTAL Smart Energy Meter and battery is disturbed.</p> <ul style="list-style-type: none"> <li>- Check RS485 connection.</li> <li>- Perform restart of the inverter and the battery. First, start battery and then connect the inverter.</li> <li>- If this error is permanently present, contact hotline.</li> </ul>	⊗
<i>Failure - Battery DC Bus (7563)</i>	<p>Battery short circuit error on the DC cables</p> <ul style="list-style-type: none"> <li>- Perform restart of the inverter and the battery. First, start battery and then connect the inverter.</li> </ul>	⊗
<i>Failure - Battery internal fault (7568)</i>	<p>Internal battery error</p> <ul style="list-style-type: none"> <li>- Perform restart of the inverter and the battery. First, start battery and then connect the inverter.</li> <li>- If this error is permanently present, contact hotline.</li> </ul>	⊗
<i>Failure - Battery Precharge (7562)</i>	<p>Battery Pre-charge error</p> <ul style="list-style-type: none"> <li>- Check selected number of modules in the battery.</li> <li>- If this error is permanently present, contact hotline.</li> </ul>	⊗

Event message	Description	Type
<i>Fan faulty</i>	<p>The internal fan of the inverter is defective. The inverter does possibly feed into the grid with reduced power.</p> <ul style="list-style-type: none"> <li>- Inform the installer.</li> </ul>	
<i>FE not connected</i>	<p>Functional ground is not connected. The inverter must not feed into the grid for safety reasons.</p> <ul style="list-style-type: none"> <li>- Inform the installer.</li> </ul>	
<i>Grid current DC offset too high</i>	<p>The DC current share fed into the grid by the inverter exceeds the permissible value. The inverter is switched off automatically due to legal requirements as long as this error condition is present.</p> <ul style="list-style-type: none"> <li>- Inform the installer.</li> </ul>	
<i>Grid frequency too high</i>	<p>The grid frequency present at the inverter exceeds the permissible value. The inverter is switched off automatically due to legal requirements as long as this error condition is present.</p> <ul style="list-style-type: none"> <li>- If the error occurs repeatedly, inform the installer.</li> </ul>	
<i>Grid frequency too high for reactivation</i>	<p>The inverter cannot feed in again after switch-off because the grid frequency exceeds the legally required switch-on value.</p> <ul style="list-style-type: none"> <li>- If the error occurs repeatedly, inform the installer.</li> </ul>	
<i>Grid frequency too low</i>	<p>The grid frequency present at the inverter falls below the permissible value. The inverter is switched off automatically as long as this error condition is present.</p> <ul style="list-style-type: none"> <li>- If the error occurs repeatedly, inform the installer.</li> </ul>	
<i>Grid frequency too low for reactivation</i>	<p>The inverter cannot feed in again after switch-off because the grid frequency falls below the legally required switch-on value.</p> <ul style="list-style-type: none"> <li>- If the error occurs repeatedly, inform the installer.</li> </ul>	
<i>Grid islanding detected</i>	<p>The grid does not carry voltage. The inverter must not feed into the grid for safety reasons. The inverter is switched off as long as this error condition is present. The display remains dark.</p> <ul style="list-style-type: none"> <li>- If the error occurs repeatedly, inform the installer.</li> </ul>	

Event message	Description	Type
<i>Grid relay defective</i>	The inverter has detected a defective grid relay and does not feed into the grid. - Inform the installer.	⊗
<i>Grid voltage Ø too high</i>	The output voltage averaged over a legally stipulated period exceeds the permissible tolerance range. The inverter is switched off automatically as long as this error condition is present. - If the error occurs repeatedly, inform the installer.	⊗
<i>Grid voltage Ø too low</i>	The output voltage averaged over a legally stipulated period falls below the permissible tolerance range. The inverter is switched off automatically as long as this error condition is present. - If the error occurs repeatedly, inform the installer.	⊗
<i>Grid voltage too high</i>	The grid voltage present at the inverter exceeds the permissible value. The inverter is switched off automatically due to legal requirements as long as this error condition is present. - If the error occurs repeatedly, inform the installer.	⊗
<i>Grid voltage too high for reactivation</i>	The inverter cannot feed in again after switch-off because the grid voltage exceeds the legally required switch-on value. - If the error occurs repeatedly, inform the installer.	⊗
<i>Grid voltage too low</i>	The grid voltage present at the inverter falls below the permissible value. The inverter is switched off automatically due to legal requirements as long as this error condition is present. - If the error occurs repeatedly, inform the installer.	⊗
<i>Grid voltage too low for reactivation</i>	The inverter cannot feed in again after switch-off because the grid voltage falls below the legally required switch-on value. - If the error occurs repeatedly, inform the installer.	⊗
<i>Intern. error</i>	- If the error occurs repeatedly, inform the installer.	⊗

Event message	Description	Type
<i>Intern. info.</i>	<ul style="list-style-type: none"> <li>- If the error occurs repeatedly, inform the installer.</li> </ul>	
<i>Intern. warning</i>	<ul style="list-style-type: none"> <li>- If the error occurs repeatedly, inform the installer.</li> </ul>	
<i>Isolation error</i>	<p>The insulation resistance between positive or negative input and ground falls below the permissible value. The inverter does not feed into the grid.</p> <ul style="list-style-type: none"> <li>- Inform the installer.</li> </ul>	
<i>L and N swapped</i>	<p>Outer and neutral conductors are connected the wrong way. The inverter must not feed into the grid for safety reasons.</p> <ul style="list-style-type: none"> <li>- Inform the installer.</li> </ul>	
<i>No branding</i>	<p>The inverter has wrong or inaccurate device data. The inverter does not feed into the grid.</p> <ul style="list-style-type: none"> <li>- Inform the installer.</li> </ul>	
<i>No connection to the energy meter</i>	<p>There is no communication connection or an incorrect communication connection between inverter and energy meter.</p> <ul style="list-style-type: none"> <li>- Have the installer check the connection.</li> </ul>	
<i>Overheating HSS</i>	<p>The maximum temperature of the boost converter has been exceeded. The inverter does not feed into the grid until the permissible temperature range has been reached.</p> <ul style="list-style-type: none"> <li>- Check mounting conditions.</li> <li>- If the error occurs repeatedly, inform the installer.</li> </ul>	
<i>Power reduction due to temperature</i>	<p>The inverter reduces its output power because the maximum temperature has been reached.</p> <ul style="list-style-type: none"> <li>- Check mounting conditions.</li> <li>- If the error occurs repeatedly, inform the installer.</li> </ul>	
<i>PV current too high</i>	<p>The input current at the inverter exceeds the permissible value. The inverter limits the current to the permissible value.</p> <ul style="list-style-type: none"> <li>- If the error occurs repeatedly, inform the installer.</li> </ul>	

Event message	Description	Type
<i>PV voltage too high</i>	<p>The input voltage present at the inverter exceeds the permissible value.</p> <ul style="list-style-type: none"> <li>- Switch off the DC disconnect of inverter and inform the installer.</li> </ul>	⊗
<i>Reading CountryCode failed</i>	<p>Inconsistency between the selected country setting and the one stored in the memory.</p> <ul style="list-style-type: none"> <li>- Inform the installer.</li> </ul>	⊗
<i>Reading CountryCode failed</i>	<p>The inverter has not been able to read out the set country correctly.</p> <ul style="list-style-type: none"> <li>- Inform the installer.</li> </ul>	⊗
<i>Residual current too high</i>	<p>The residual current flowing from the positive or negative input through the PV generators to ground exceeds the legally permissible value. The inverter is switched off automatically as long as this error condition is present.</p> <ul style="list-style-type: none"> <li>- Inform the installer.</li> </ul>	⊗
<i>RS485-Gateway activated</i>	<p>It is not possible to communicate with the inverter via the RS485 interface.</p> <ul style="list-style-type: none"> <li>- Disconnect inverter from the grid and restart (AC reset).</li> <li>- Inform the installer.</li> </ul>	i
<i>Self test failed</i>	<p>An error has occurred during self-test; the self-test has been aborted.</p> <ul style="list-style-type: none"> <li>- If the self-test is repeatedly aborted at different times of the day although the grid voltage and frequency lie within the limit values of the country setting, inform the installer.</li> </ul>	⊗
<i>Software incompatible</i>	<p>After a firmware update the various software versions in the inverter do no longer match.</p> <ul style="list-style-type: none"> <li>- Perform the firmware update again with a valid update file.</li> <li>- If the error occurs repeatedly, inform the installer.</li> </ul>	⊗
<i>System on lockdown</i>	<p>This error is always generated together with the error "Battery input error detected".</p> <ul style="list-style-type: none"> <li>- Proceed as described in "Battery input error detected".</li> </ul>	⊗



Event message	Description	Type
<i>Time/date lost</i>	The inverter has lost the time because it has been disconnected from the grid for too long. Storage of yield data is only possible with the wrong date. - Correct the time in "Settings" > "Time/date".	

## 10 Maintenance and care



### **DANGER**

Voltage.

There is a risk of death by electrocution.

- ▶ Only clean device with a slightly moist cloth.
- ▶ Any repair work may only be carried out by the manufacturer's customer service department.

Except for the care of its exterior, the inverter is maintenance free.

- Remove dust with compressed air (max. 2 bar).
- Remove soiling with a slightly damp cloth (use clear water). In case of heavy soiling, use a cleaning agent without solvents or disinfectants, that does not contain any granular or sharp-edged substances.

## 11 Disposal



- ▶ Do not dispose of the inverter with household waste.
- ▶ Return the inverter to KOSTAL Solar Electric GmbH customer service with the note: "For disposal".
- ▶ The device packaging consists of recyclable materials.

## 12 Technical data

### 12.1 PIKO MP plus 1.5-1, 2.0-1, 2.5-1, 3.0-1 and 3.6-1

	PIKO MP plus 1.5-1	PIKO MP plus 2.0-1	PIKO MP plus 2.5-1	PIKO MP plus 3.0-1	PIKO MP plus 3.6-1
Installation altitude	Max. 2000 m above sea level				
<b>DC input side (PV generator connection)</b>					
Max. input voltage	450 V			750 V	
MPP voltage range	75 V to 360 V			125 V to 600 V	150 V to 600 V

	PIKO MP plus 1.5-1	PIKO MP plus 2.0-1	PIKO MP plus 2.5-1	PIKO MP plus 3.0-1	PIKO MP plus 3.6-1
Operating voltage range at nominal power	120 V to 360 V	160 V to 360 V	200 V to 360 V	230 V to 600 V	280 V to 600 V
Number of MPP trackers	1				
Max. input current	13 A				
Max. input power with max. output active power	1540 W	2050 W	2560 W	3070 W	3770 W
Max. short-circuit current	15 A				
Maximum energetic recovery current of the inverter to the solar module	0 A				
<b>AC output side (grid connection)</b>					
Output voltage	185 V to 276 V				
Nominal output voltage	230 V				
Max. output current	12 A	12 A	14 A	14 A	16 A
Max. active power (cosPhi = 1)	1500 W	2000 W	2500 W	3000 W	3680 W
Maximum apparent power	1500 VA	2000 VA	2500 VA	3000 VA	3680 VA
Nominal power	1500 W	2000 W	2500 W	3000 W	3680 W
Nominal frequency	50 Hz and 60 Hz				
Grid frequency	45 Hz to 65 Hz				
Power loss during nighttime operation	< 3 W				
Feed-in phases	One-phase				
Distortion factor (cosPhi = 1)	< 3 %				
Power factor cosPhi	0.8 capacitive to 0.8 inductive				
Highest output fault current	0.0 A				
Highest overcurrent protection	28 A			40 A	

	PIKO MP plus 1.5-1	PIKO MP plus 2.0-1	PIKO MP plus 2.5-1	PIKO MP plus 3.0-1	PIKO MP plus 3.6-1
<b>Characterisation of the operating behaviour</b>					
Max. efficiency	97.40 %	97.40 %	97.40 %	97.00 %	97.00 %
European efficiency	96.10 %	96.50 %	96.60 %	96.30 %	96.30 %
MPP efficiency	> 99.7 % (static), > 99 % (dynamic)				
Internal consumption	< 20 W				
Power derating (power reduction) at full power from	50 °C (T <sub>amb</sub> )				45 °C (T <sub>amb</sub> )
<b>Safety</b>					
Isolation principle	No galvanic isolation, without transformer				
Grid monitoring	Yes, integrated				
Residual current monitoring	Yes, integrated (the inverter cannot cause a DC residual current due to the design)				
Protection class	Protection class 2 (RCD type A sufficient)				
<b>Operating conditions</b>					
Area of application	Indoors, outdoors (degree of soiling 3)				
Climate category i.a.w. IEC 60721-3-4	4K4H				
Ambient temperature	-25 °C to +60 °C				
Storage temperature	-30 °C to +80 °C				
Relative humidity	0 % to 100 %, non-condensing				
Noise emission (typical)	31 dB(A)				
<b>Equipment and design</b>					
Degree of protection	IP 65				
Overvoltage category	III (AC), II (DC)				
DC connection	Phoenix Contact SUNCLIX (1 pair), mating plugs included in the scope of delivery				
AC connection	Wieland RST25i3 plug, mating plug included in the scope of delivery				
Dimensions	399 x 657 x 222 mm				
Weight	11.7 kg			12.4 kg	
Communication interfaces	RS-485 (1 x RJ45 socket), Ethernet- interface (1 x RJ45), Modbus RTU (1 x RJ45 socket: connection to energy meter)				

	PIKO MP plus 1.5-1	PIKO MP plus 2.0-1	PIKO MP plus 2.5-1	PIKO MP plus 3.0-1	PIKO MP plus 3.6-1
Integrated DC disconnect	Yes, conform to DIN VDE 0100-712				
Cooling principle	Temperature controlled fan, variable-speed, internal (dust-protected)				
Test certificate	Refer to certificates download at the product page of homepage				

## 12.2 PIKO MP plus 3.0-2, 3.6-2, 4.6-2 and 5.0-2 \*

	PIKO MP plus 3.0-2	PIKO MP plus 3.6-2	PIKO MP plus 4.6-2	PIKO MP plus 5.0-2
Installation altitude	Max. 2000 m above sea level			
<b>DC input side (PV generator connection)</b>				
Max. input voltage	750 V			
MPP voltage range	125 V to 600 V	150 V to 600 V	150 V to 600 V	150 V to 600 V
Operating voltage range at nominal power	230 V to 600 V	280 V to 600 V	360 V to 600 V	360 V to 600 V
Number of MPP trackers	2			
Max. input current	2 x 13 A			
Max. input power with max. output active power	3070 W	3770 W	4740 W	5200 W
Max. short-circuit current	15 A			
Maximum energetic recovery current of the inverter to the solar module	0 A			
<b>AC output side (grid connection)</b>				
Output voltage	185 V to 276 V			
Nominal output voltage	230 V			
Max. output current	14 A	16 A	20 A	22 A
Max. active power (cosPhi = 1)	3000 W	3680 W	4600 W	5000 W
Maximum apparent power	3000 VA	3680 VA	4600 VA	5000 VA
Nominal power	3000 W	3680 W	4600 W	5000 W
Nominal frequency	50 Hz and 60 Hz			

\* Available as of Q2/2020

	PIKO MP plus 3.0-2	PIKO MP plus 3.6-2	PIKO MP plus 4.6-2	PIKO MP plus 5.0-2
Grid frequency	45 Hz to 65 Hz			
Power loss during nighttime operation	< 3 W			
Feed-in phases	One-phase			
Distortion factor (cosPhi = 1)	< 3 %			
Power factor cosPhi	0.8 capacitive to 0.8 inductive			
Highest output fault current	0.0 A			
Highest overcurrent protection at the output	40 A	40 A	57 A	57 A
<b>Characterisation of the operating behaviour</b>				
Max. efficiency	97.00 %	97.00 %	97.40 %	97.40 %
European efficiency	96.30 %	96.30 %	96.90 %	96.80 %
MPP efficiency	> 99.7 % (static), > 99 % (dynamic)			
Internal consumption	< 20 W			
Power derating at full power from	45 °C (T <sub>amb</sub> )	45 °C (T <sub>amb</sub> )	40 °C (T <sub>amb</sub> )	40 °C (T <sub>amb</sub> )
<b>Safety</b>				
Isolation principle	No galvanic isolation, without transformer			
Grid monitoring	Yes, integrated			
Residual current monitoring	Yes, integrated (the inverter cannot cause a DC residual current due to the design)			
Protection class	Protection class 2 (RCD type A sufficient)			
<b>Operating conditions</b>				
Area of application	Indoors, outdoors (degree of soiling 3)			
Climate category i.a.w. IEC 60721-3-4	4K4H			
Ambient temperature	-25 °C to +60 °C			
Storage temperature	-30 °C to +80 °C			
Relative humidity	0 % to 100 %, non-condensing			
Noise emission (typical)	31 dB(A)			
<b>Equipment and design</b>				
Degree of protection	IP 65			
Overvoltage category	III (AC), II (DC)			

	<b>PIKO MP plus 3.0-2</b>	<b>PIKO MP plus 3.6-2</b>	<b>PIKO MP plus 4.6-2</b>	<b>PIKO MP plus 5.0-2</b>
DC connection	Phoenix Contact SUNCLIX (2 pair), mating plugs included in the scope of delivery			
AC connection	Wieland RST25i3 plug, mating plug included in the scope of delivery			
Dimensions	399 x 657 x 222 mm			
Weight	13 kg	13 kg	13.1 kg	13.1 kg
Communication interfaces	RS-485 (1 x RJ45 socket), Ethernet- interface (1 x RJ45), Modbus RTU (1 x RJ45 socket: connection to energy meter)			
Integrated DC disconnecter	Yes, conform to DIN VDE 0100-712			
Cooling principle	Temperature controlled fan, variable-speed, internal (dust-protected)			
Test certificate	Refer to certificates download at the product page of homepage			



# KOSTAL

KOSTAL Solar Electric GmbH  
Hanferstr. 6  
79108 Freiburg i. Br.  
Deutschland  
Telefon: +49 761 47744 - 100  
Fax: +49 761 47744 - 111

KOSTAL Solar Electric Ibérica S.L.  
Edificio abm  
Ronda Narciso Monturiol y Estarriol, 3  
Torre B, despachos 2 y 3  
Parque Tecnológico de Valencia  
46980 Valencia  
España  
Teléfono: +34 961 824 - 934  
Fax: +34 961 824 - 931

KOSTAL Solar Electric France SARL  
11, rue Jacques Cartier  
78280 Guyancourt  
France  
Téléphone: +33 1 61 38 - 4117  
Fax: +33 1 61 38 - 3940

KOSTAL Solar Electric Hellas E.Π.Ε.  
47 Steliou Kazantzidi st., P.O. Box: 60080  
1st building – 2nd entrance  
55535, Pilea, Thessaloniki  
Ελλάδα  
Τηλέφωνο: +30 2310 477 - 550  
Φαξ: +30 2310 477 - 551

KOSTAL Solar Electric Italia Srl  
Via Genova, 57  
10098 Rivoli (TO)  
Italia  
Telefono: +39 011 97 82 - 420  
Fax: +39 011 97 82 - 432

KOSTAL Solar Electric Turkey  
Mahmutbey Mah. Taşocağı Yolu  
No:3 (B Blok), Ağaoğlu My Office212,  
Kat:16, Ofis No: 269  
Bağcılar - İstanbul  
Türkiye  
Telefon: +90 212 803 06 24  
Faks: +90 212 803 06 25

KOSTAL (Shanghai) Management Co., Ltd  
Yuan Gao Road 77, Anting, Jiading,  
201814 Shanghai, China  
Tel: +86 21 5957 0077-7189  
Fax: +86 21 5957 8294

[www.kostal-solar-electric.com](http://www.kostal-solar-electric.com)