

# INSTALLATION MANUAL

**For the aleo modules**

**with standard frame 42mm::  
X63; X61; X83; X81**

**with standard frame 35 mm:  
P23**

**with standard frame 40 mm:  
LEO (L62, L64); LEO Black (L82, L84)**

**with frame for the roof integration:  
S83sol; S81sol, LEO Sol**

Please read carefully prior to installation. Store in a safe place for maintenance.

Installation manual version. 4.9, 07/2022, EN

**aleo**

## 1 This manual in other languages

Deutsch (de-DE)	<b>Wenn Sie diese Kurzanleitung in deutscher Sprache benötigen, wenden Sie sich bitte an aleo solar, siehe Kap. 2.2.</b>
Français (fr-FR)	<b>Pour avoir cette notice d'installation en Français contactez aleo solar (voir chapitre 2.2).</b>
Italiano (it-IT)	<b>Ove necessitate delle seguenti istruzioni d'uso in lingua italiana, vogliate gentilmente rivolgervi a aleo solar, vedi cap 2.2.</b>
Polski (pl-PL)	<b>Jeżeli potrzebują Państwo niniejszej instrukcji obsługi w języku polskim, prosimy o skontaktowanie się z aleo solar, patrz część 2.2.</b>
Nederlands (Benelux) (nl-BE)	<b>Wenst u deze handleiding in het Nederlands te ontvangen, neem dan contact op met de klantenservice van aleo solar zie hoofdstuk 2.2.</b>

## 2 Product support

### 2.1. Detailed information

In addition to this Reference Manual, aleo solar also provides further information on its website.

### 2.2. Contact

aleo solar GmbH  
Marius-Eriksen-Straße 1  
17291 Prenzlau  
Germany

T +49 (0)3984 8328-0  
F +49 (0)3984 8328-115  
E [info@aleo-solar.com](mailto:info@aleo-solar.com)  
W [www.aleo-solar.com](http://www.aleo-solar.com)

### 2.3. Copyright

© 2022 aleo solar GmbH

This installation manual is protected by copyright. All rights reserved. Copying, reproduction, translation, or conversion to any type of electronic media or machine-readable form, in its entirety or parts, is not permitted. An exception will be made for a backup copy for your own use.

aleo solar reserves the right to change this document without prior notice.

aleo® and aleo solar® are registered, protected trademarks of aleo solar GmbH.

### 3 Table of content

1	This manual in other languages .....	2	11.3 Screw mounting.....	14
2	<b>Product support</b> .....	2	11.4 Insertion mounting.....	14
2.1.	Detailed information .....	2	11.5 Modules with Solrif® frame.....	14
2.2.	Contact.....	2	11.6 Load levels .....	14
2.3.	Copyright.....	2	11.7 Mounting drawings for modules with standard frame.....	16
3	<b>Table of content</b> .....	3	<b>12 For operators: maintenance</b> .....	21
4	<b>Explanation of safety guidelines</b> .....	4	12.1 Inspection.....	21
4.1	Warnings and advices in this manual.....	4	12.2 Review.....	21
4.2	Notes on modules.....	4	12.3 Details for the inspections .....	21
5	<b>About this manual</b> .....	4	12.4 Cleaning.....	21
5.1	Detailed information for installers and planners .....	4	12.5 Repairs .....	23
6	<b>Handling aleo modules</b> .....	5	<b>13 For operators: decommissioning</b> .....	23
6.1	Intended use.....	5	13.1 Safety precautions.....	23
7	<b>Transport</b> .....	6	13.2 Disposal .....	23
8	<b>Preparing for installation</b> .....	6	13.3 Returns .....	23
8.1	Handling aleo modules .....	6	13.4 PV Cycle.....	23
8.2	Safety precautions.....	7		
9	<b>Mechanical installation</b> .....	8		
9.1	Mounting orientation of modules .....	8		
9.2	Safety precautions.....	8		
9.3	Improper mounting .....	8		
9.5	Avoiding seals.....	9		
9.6	Clearance under the modules .....	9		
9.7	Shadowing.....	9		
10	<b>Electrical installation</b> .....	10		
10.1	Connectors.....	10		
10.2	Laying the string cables.....	10		
10.3	Potential equalization (earthing) of module frames .....	11		
10.4	Lightning protection .....	12		
10.5	Parallel and serial connection.....	12		
11	<b>Details of mechanical mounting</b> .....	13		
11.1	Aligning the mounting profiles .....	13		
11.2	Clamp mounting for modules with standard frame .....	13		

## 4 Explanation of safety guidelines



This is the danger symbol. It is used in several versions in this manual to alert you to the potential risk of personal injury.

### 4.1 Warnings and advices in this manual

The danger warnings are structured as follows:

**Type and source of danger: Possible consequences of non-observance.**

- Measures or prohibitions to avoid danger



**DANGER!**

**DANGER** indicates an imminently dangerous situation which inevitably leads to death or serious injury if not avoided.

---

The information on warning and cautions is structured as follows:

**Type and source of danger: Possible consequences of non-observance.**

- Measures or prohibitions to avoid danger



**WARNING!**

**WARNING** indicates a potentially dangerous situation which can lead to death or serious injury if not avoided.



**CAUTION!**

**CAUTION** indicates a potentially dangerous situation which can lead to slight or semi-serious injury if not avoided.

---

**NOTE**

**NOTE** indicates a potentially dangerous situation which can cause material damage if not avoided.

## 4.2 Notes on modules

The following symbol is attached to the modules:



If this symbol also appears on a danger or warning product label, it is warning you of the danger caused by electric current or voltage which can lead to personal injury if you fail to observe the instructions.

## 5 About this manual

This manual is release 4.9 with the issue date 01/2022. The publication of this manual renders all previous releases of this manual invalid.

aleo solar constantly strives to improve its products and their documentation. Therefore, we advise you to always use the latest version of the manual.

Hand over this installation manual to the operator after installation and ensure you have confirmation of receipt.

### 5.1 Detailed information for installers and planners

#### 5.1.1 Information on the aleo solar website

You can find the latest release of the installation manual and additional information on aleo solar's website: [www.aleo-solar.com](http://www.aleo-solar.com).

Always use the latest version for your modules if you find a more recent release of the manual.

#### 5.1.2 Information sources for operators

If you have any queries about the latest release, contact your aleo solar specialist partner or aleo solar directly (see chap. 2.2: „Contact“).

## 6 Handling aleo modules

### 6.1 Intended use

#### 6.1.1 Appropriate use

aleo modules are used for generating electrical power in stationary, photovoltaic systems which are connected to the grid. If you would like to use the modules for another purpose, such as for charging an accumulator directly, you may need additional components (e.g. string diodes).

aleo modules are suitable for installing near livestock farms and coastal regions.

Observe all the applicable legislation, regulations, guidelines and standards when installing and operating the modules.

#### 6.1.2 Inappropriate use

##### NOTE

- Do not install aleo modules on vehicles and do not use them in air, space or seafaring applications and also not 2000 m<sup>1</sup> above sea level.
- Do not use aleo modules if they are exposed to concentrated sunlight or strong artificial light, or if they could be immersed in water or other liquids or exposed to vapour.
- Exclude the usage of our modules in heavily dirty environments.



##### WARNING!

- Avoid using any aggressive chemical substances (e.g. herbicides) in the vicinity of the installation of aleo modules.

#### 6.1.3 Product-specific information

Product-specific information (e.g. data sheet) contains details of a particular type of module.

Only use aleo modules for the intended purpose outlined in the product-specific information. These modules are rated for use in application class A/ protection class II according to IEC 61730. For the electrical data please refer to the data sheet or the name plate.

Under normal conditions, solar modules are likely to experience conditions that produce more current and/or voltage than reported at standard test conditions.<sup>2</sup> Accordingly, the values of  $I_{SC}$  and  $U_{OC}$  marked on the modules should be multiplied by a factor of 1.25 when determining component voltage ratings, conductor ampacities, fuse sizes and size of controls connected to the PV output.

<sup>1</sup> According to IEC 61730.

<sup>2</sup> E.g. in the event of strong solar irradiation, low ambient temperature and reflections from snow.

If the information in the data sheet differs from this manual, the datasheet takes precedence.

### 6.2 Personal protection

#### 6.2.1 Electrical safety precautions



##### DANGER!

High DC voltages during storage, installation, operation and maintenance: Risk of fatal electric shock!

- aleo modules may only be installed by qualified technicians with a high level of expertise.



##### DANGER!

Dangerous, high DC voltages are generated even at low levels of light, especially in a series connection: Risk of fatal electric shock!

- Never touch the electrical connections of a solar module under any circumstances, not even if you have disconnected the photovoltaic generator.



##### DANGER!

Electric arcs form when electrical connections are made or disconnected incorrectly: Severe or fatal injuries from electric shock or severe injury from burns!

- Before you carry out any work on electrical components, disconnect the photovoltaic generator.



##### DANGER!

Contact with live parts due to defective insulation or damaged/fallen off junction box covers: Severe or fatal injuries from electric shock!

- Do not touch damaged parts with your bare hands.
- Use protective clothing and suitable, insulated tools.



##### DANGER!

High DC voltages possible, even when the PV generator is disconnected, if the generator is earthed: Severe or fatal injuries from electric shock!

- If the circuit of your photovoltaic generator is earthed, remove the earth before you carry out electrical work on the generator.



### WARNING!

Contact with live parts due to unsuitable tools or weather conditions: Risk of electric shock!

- Only use approved, insulated tools for maintenance work on live parts.
- Work in dry conditions. Ensure that the electrical connections of the solar module, the cables and the tools are dry.

## NOTE

Work in pairs so that in an emergency one person can help in the case of injury. This is because the modules generate voltage as soon as they are exposed to light. Therefore, parts of the system are nearly always energised during the daytime.

### 6.2.2 Mechanical safety precautions



### WARNING!

Glass can crack, break or splinter. Beware of injury!

- Never step or sit on solar modules.
- Avoid knocking and bumping the surface, the edges and corners of the glass panels.



### WARNING!

Exposed live parts due to damaged glass: Risk of electric shock!

- Only use modules with the insulation in perfect conditions.



### CAUTION!

Sharp glass edges or flying glass splinters.: Beware of injury!

- Always use suitable protective equipment (e.g. gloves and safety goggles).
- Be especially careful with the glass edges and corners of laminates (frameless modules).



### WARNING!

Damaged insulating back sheet. Risk of electric shock and burns!

- Avoid any contact with the back of the module with sharp or pointed objects.
- Ensure that the back sheet remains undamaged.

## 7 Transport

- The aleo modules are transported upright in order to avoid mechanical stresses on the modules that can otherwise occur under normal transport conditions.
- Do not expose the aleo modules to excessive shocks or vibrations during transport (e.g. helicopter transport).

## 8 Preparing for installation

### 8.1 Handling aleo modules

#### 8.1.1 Storing modules

- Modules in packaging units:

## NOTE

- Store the aleo modules upright in the packaging units. Make sure that each module has sufficient support.
- Do not stack the packaging units. This could damage the modules.
- Store the modules in dry conditions. Packaging is not waterproof.
- Store the modules at an ambient temperature of max. 40 °C.

- Individual modules:

## NOTE

- Store individual aleo modules in an upright position on wedges with suitable padding. Use adequate padding between the modules.
- Avoid stacking individual modules, as well as the pallets they rest on.
- Store the modules in dry conditions.
- Store the modules at an ambient temperature of max. 40 °C.

#### 8.1.2 Unpacking modules

- Framed modules

## NOTE

- Using an underlay, incline the pallet (e.g. with a beam, height approx. 10 cm for 5° inclination), so that the opening on the front of the box is elevated. The modules then lean back in the box which makes it easier to remove them.
- Use an underlay for inclining which supports the whole side of the pallet (e.g. a beam). This keeps

the modules supported in the box along their entire width.

- Remove the module from this side only. Remove the module with the help of another person.
- Observe the unpacking instructions on the module box.
- Cork pads on the back of the frame or cardboard layers between the modules are used as spacers between the modules. All spacers must be removed from the module before installation.

### 8.1.3 Checking modules

#### NOTE

- Before installation, check each aleo module for mechanical defects. Pay particular attention to possible damage to glass panels and insulated backsheets.
- In addition, check the insulation on the cables, connectors and junction boxes.
- If you discover any defects, report them to the supplier or transport company immediately.

### 8.1.4 Transporting modules to installation site

#### NOTE

- Always carry the aleo module with one other person. Take hold of the module on its long sides.
- When transporting individual modules, make sure that you do not put any strain or pressure on the junction box and cables. The junction box must not be used as a carrying handle.

## 8.2 Safety precautions

### DANGER!

**When installing on roofs or other elevated sites, objects may fall down: Severe or fatal injuries are possible!**

- Block off the danger zone for people and animals before beginning installation work. If possible, remove all objects from the danger zone.

### DANGER!

**Electric arcs form when electrical connections are made or disconnected incorrectly: Severe or fatal injuries from electric shock or severe injury from burns!**

- Disconnect the photovoltaic generator before you carry out any work on the electrical components of the photovoltaic generator.

### DANGER!

**High DC voltages possible, even when the photovoltaic generator is disconnected, if the generator is earthed: Severe or fatal injuries from electric shock!**

- If the circuit of your photovoltaic generator is earthed, remove the earth before carrying out electrical work on the generator.

### WARNING!

**Exposed live parts on damaged modules: Danger of electric shock!**

- Only use components which are in perfect condition for use in photovoltaic systems. Do not install solar modules with visible damage to the glass panels, the insulating back sheet or on the insulation of electrical connections.

### WARNING!

**Contact with live parts due to unsuitable tools or wet conditions: Danger of electric shock!**

- Only use approved, insulated tools for installation or maintenance work on live parts.
- Work in dry conditions. Make sure that the electrical connections on the solar module, the cables used for installation and the tools, are dry.

## 8.3 Health and safety

### CAUTION!

**Risk of slipping due to wind, rain, snow or ice: Risk of injury due to falling or colliding with objects!**

- Avoid unfavourable weather conditions, such as strong wind or rain.
- Also avoid working on the installation site in ice and snow.
- Use the safety equipment required or recommended by local regulations, such as hard hats, steel-capped shoes with rubber soles, protective goggles, gloves or fall-protection systems.

### CAUTION!

**Hot module parts in strong sunlight: Risk of burning!**

- Protect yourself from burning by wearing gloves and suitable clothing.

## 9 Mechanical installation

### 9.1 Mounting orientation of modules

#### 9.1.1 Vertical (portrait) mounting

When mounting the module vertically, make sure that the cables of the junction box are facing towards the ground.

#### 9.1.2 Horizontal (landscape) mounting (for module types X61, X63, X81, X83 and P23)

When mounting horizontally, make sure that the exit holes for the cables on the module or the junction box are positioned on the inside of the photovoltaic generator (see fig. 1). Avoid the lateral outer edges of the photovoltaic generator to minimise the effect of ambient conditions, such as wind or rain.

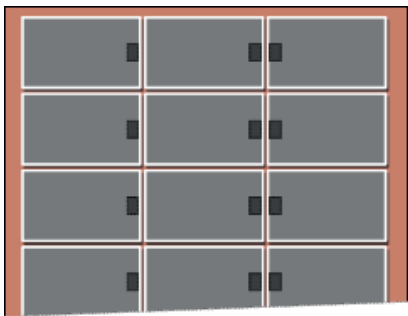

Fig. 1 Recommended position of the junction boxes for horizontal mounting (facing the middle of the generator).

#### 9.1.3 Inclination

Incline the surface of the modules at an angle of at least 10° horizontally, so that precipitation can drain off which supports the modules self-cleaning. For optimum self-cleaning, aleo recommends an angle of at least 15° horizontally.

In case of flat installation, we recommend the use of our frameless module.

### 9.2 Safety precautions

#### NOTE

- Do not drill any additional hole in the frame of aleo modules.

### 9.3 Improper mounting

#### NOTE

- Do not attach the modules using nails. The vibration created in the process can cause micro fissures and loss of yield, and results in loss of warranty rights.
- Do not attach the modules by welding. The temperatures created in the process can cause delamination,

micro fissures and loss of yield, and results in loss of warranty rights.

### 9.4 Intervals

#### 9.4.1 Intervals between modules with standard frame

#### NOTE

- Leave a minimum clearance when mounting modules. This prevents mechanical tension due to thermal expansion.
- When mounting at intervals, leave a clearance of 5 mm or more between the individual module frames.
- For edge-to-edge mounting, allow for an expansion joint of 30 mm after a maximum of 7 m.

aleo solar recommends mounting at intervals. Also note the information from the mounting equipment vendor. This could specify larger intervals.

#### 9.4.2 Clearance under the modules

- Minimum clearance

#### NOTE

##### Rooftop or freefield mounting

- Ensure a clearance of at least 4 cm between the rear edge of the frame and the mounting surface (e.g. the roof tiles) for the rear ventilation of the aleo module.

##### Roof integrated mounting

- Ensure an appropriate interval, for example, to the trough of the mounting system. Also ensure adequate ridge ventilation, for example, with a roof ridge ventilator.

- Maximum clearance

#### NOTE

- The largest permissible clearance is defined by national standards. This is used to design the installation on the assumed effects of wind and suction.
- The actual maximum clearance of an installation is determined by the sub-structure. Ensure that your sub-structure adheres to the permissible clearances.



## 9.5 Avoiding seals

### NOTE

- Avoid the use of a seal between aleo modules and their mounting surface.
- Dry and cool operation can have a positive effect on the performance as well as the service life of an aleo module.
- Also for roof-integrated mounting, ensure good rear ventilation to minimise loss of output which results from a higher module temperature. Ensure adequate ridge ventilation, for example, with a roof ridge ventilator.

## 9.6 Clearance under the modules

### NOTE

- Keep the space behind the laminate free of any objects. This prevents damage to the insulating back sheet and the junction box.
- Ensure that sharp or conductive parts (e.g. screws or nails) do not protrude into the space behind the module.
- If possible, take measures to prevent foreign objects (e.g. snow, ice, leaves, twigs, branches from being able to get behind the module.

## 9.7 Shadowing

### 9.7.1 Avoidance of shadowing

### NOTE

- Avoid shadowing of solar modules. This applies also and especially for shadowing of small areas due to close small objects like antennas or lightning protectors.
- If there is systematic shadowing in the course of the day or year because of adjacent objects at the site and you do not have any opportunity to affect the shadowing, then:
  - take another site into consideration or
  - only plan with the non-shadowed parts of your site when you configure your photovoltaic generator.

### 9.7.2 Effects of shadowing

### NOTE

Even shadowing of a single module or solar cell can appreciably affect the power output of your photovoltaic plant.

If shadow falls on single solar modules of a photovoltaic generator or on single solar cells of a solar module, the shadowed parts generate less or no electrical power anymore. This may affect the yield of the whole module string and therefore the whole generator.

Furthermore, shadowing often causes the solar cells to consume the otherwise in the module generated electrical power. This may cause warming of the shadowed cells in comparison to the not shaded cells, which in extreme cases can raise the risk of fire.

Constant or systematic shadowing can cause a serious yield loss and may accelerate the aging process and therefore causes power loss or failures of the photovoltaic generator. Avoid shadowing e.g. caused by building parts, depending on day time or season (esp. in winter) to optimize the yield and durability of your plant.

### 9.7.3 Protective devices of the modules

Aleo modules are equipped with bypass-elements to limit the temperature rising because of the internal power consumption induced by shadowing to a non-critical grade and thus protect the module.

Avoid systematic shadowing also because the bypass-elements are not suited for constant, long lasting loads.

## 10 Electrical installation

### 10.1 Connectors



#### WARNING!

Incompatible or unsuitable connectors can overheat: Fire hazard!

- Only use connectors that are the same type and from the same manufacturer.
- Using different types of connectors or ones from different manufacturers is not allowed, even if:
  - connecting is possible,
  - the connectors have the same basic designation (e.g. "MC4") or
  - they are designated as "compatible".

You can find more details on this in the next two sections.

#### 10.1.1 Module connectors

The various module types can be fitted with the following connectors:

- Original Multicontact® MC4 (with locking)<sup>3</sup>,
- PV-JM601 (with locking).

You can find the specific connectors in the module data sheet.

#### 10.1.2 Connector peculiarities HINWEIS

#### NOTE

- **Original Multicontact® MC4-connectors:**

Only plug original Multicontact® MC4-connectors into original-Multicontact® MC4-connectors

- **PV-JM601 connectors:**

Only plug PV-JM601 connectors into PV-JM601 connectors.

#### 10.1.3 Replacing the connectors

You can remove the connector on a module and replace it with another connector, which is released by aleo (see chap. 9.1.2) if necessary.

You retain the manufacturing warranty if you remove and mount with approved tools in the proper way and according to the connector manufacturer's instructions.

### 10.2 Laying the string cables



#### CAUTION!

Brittle fractures in junction boxes due to contact with unsuitable connection cables: Risk of fire!

- Only use connection cables without plasticisers, certified according to the current valid standard.<sup>4</sup>

#### NOTE

- Avoid any tensile and pressure loads on the junction box when mounting.
- When mounting, avoid heavy tensile loads on any connectors already plugged in.

#### NOTE

- Bend the cables from the connector at least 4 cm after they exit from the connector.
- Bend the cables from the junction box as well, at least 4 cm after they exit from the connector.

This keeps the cables waterproof at the cable outlet.

Observe the guidelines on laying the respective cables.

Lay all cables ensuring that:

- you adhere to the minimum bend radius (e.g. 5-fold cable diameter<sup>5</sup>),
- you avoid laying near sharp corners and edges or protect the cables accordingly,
- cables must not lay between module backside and mounting system parts,
- you protect them from direct sunlight and precipitation,
- you secure the cables with UV resistant cable clips<sup>6</sup> or other suitable cable fasteners which protect the cable insulation,
- cables from module strings are laid as near to each other as possible to minimise the effects of being struck by lightning.

<sup>3</sup> The original Multicontact® MC4 connectors are referred to as "Genuine MC4" in the data sheet.

<sup>4</sup> Current standard for solar DC cables in Europe: EN 50618.

<sup>5</sup> Some countries specify a larger bend radius, e.g. 8-fold wire diameter in the USA (NEC Codebook 2011).

<sup>6</sup> For attaching cable clips, use a suitable tool which constrict or damage the cable insulation by tightening.

## 10.2.1 Weather protection

### NOTE

- Lay the cables so that they exit the junction box from below. This prevents water, which runs along the cable, from collecting at the point where the cables exit the junction box.
- For modules mounted horizontally, lay the cables in a U-form away from the junction box (see fig. 2).
- Modules mounted vertically do not usually need any additional adjustments.

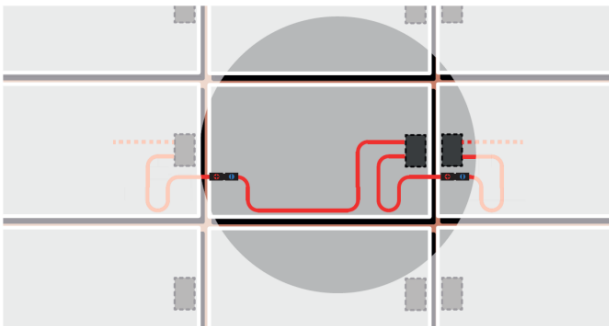

Fig. 2 U-form cables at the junction box for a horizontally mounted module

Lay cables carefully to protect against damage from:

- direct environmental factors, such as precipitation,
- movement (e.g. from wind),
- indirect environmental factors, e.g. snow or ice, which slip down behind the modules and
- chaffing on the insulation due to the cable moving (e.g. from wind or ice).

## 10.3 Potential equalization (earthing) of module frames

### NOTE

- Local regulations may specify potential equalisation (earthing).
- When earthing the module frame, establish a safe electrical connection to the earth potential or earthed sub-structure.
- Observe the requirements and recommendations of the inverter manufacturer, as well as insurance policies.
- The module frames are made of aluminium. When mounting onto other materials, take suitable measures to prevent electric corrosion, e.g. by using a coating.

- aleo solar recommends integrating the frames of the modules in the so-called protective equipotential bonding (colloquially: earthing). This allows you to reduce the risk of electric shocks in the case of damage or installation errors.
- aleo solar also recommends earthing the frames of the modules individually so that the other modules remain grounded if you remove an individual module from the photovoltaic system.
- You can make the earthing together with the clamp or screw mounting, or by using the grounding holes.
- Please observe the instructions of the mounting system manufacturer for earthing.

You have the option of earthing a module frame with its own screw connection. This is a direct potential equalization. For this purpose, the module frames have each long side near the short side, which are marked with this symbol:



Use only the earthing holes for equipotential bonding in inlay systems.

Observe the following information:

- The diameter of the earthing holes is 4.35 ( $\pm 0.2$ ) mm; the frame thickness is 1.5 mm.

Use appropriate self-aligning, thread-cutting screws and a toothed lock washer (both made of stainless steel) to ensure reliable contact between the screw and the ring cable lug. The screws must not be allowed to loosen.

For modules with in-roof Solrif® frames, please refer to the instructions provided by Ernst Schweizer for this installation. These instructions can be found on the website of Ernst Schweizer AG Metallbau or on the aleo website: [www.aleo-solar.de](http://www.aleo-solar.de).

Potential equalization does not serve as lightning protection. Lightning protection may be necessary in addition to potential equalization.

## RECOMMENDATION

## 10.4 Lightning protection



### WARNING!

**Absence of or inadequate lightning protection: Risk of fire or electric shock!**

- Leave the planning and installation of the external, and if required internal, lightning protection to be always carried out by qualified technicians.
- It is essential to integrate an arrester for connecting the lightning rod with the lightning protection. This ensures the safety and reliability of the lightning protection as well as the photovoltaic system.
- Do not under any circumstances include the module frame or its earth as an active part of the lightning protection (e.g. as a lightning arrester).

### NOTE

If you earth the module frame, the only task of this earth is the potential equalisation between the module frame and the supporting structure.

## 10.5 Parallel and serial connection

PV modules of the same type can be connected in parallel. The PV modules in this series are fundamentally designed for series connection.

- Only use PV modules of the same type and output for parallel connection. Take measures for over-current protection (e.g. line fuses) if necessary. Never exceed the specified reverse current loadability of the PV modules. Maximum number of module strings that are allowed to be switched in parallel:  $2 \text{ (fuse rating / (short-circuit current} \times 1.25) + 1)$
- Make sure that only PV modules with the same amperage ( $I_{MPP}$ ) are interconnected for series connection and make sure that the voltages of strings connected in parallel are the same. Even at low temperatures, never exceed the maximum permissible system voltage of the PV modules. Maximum number of PV modules that are allowed to be switched in series:  $\text{maximum system voltage} / (\text{open circuit voltage} \times 1.25)$ , with respect to the temperature coefficient.
- Make sure that the number and connection of the PV modules match the electrical values specified by the devices connected to the photovoltaic system.
- Make sure that the polarity is correct.

## 11 Details of mechanical mounting

### 11.1 Aligning the mounting profiles

#### 11.1.1 Permissible alignment

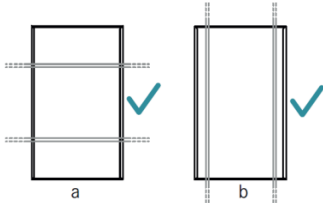

Fig. 3 Permissible alignment of mounting profiles

a, b: Parallel profiles for mounting

#### 11.1.2 Not permissible alignment

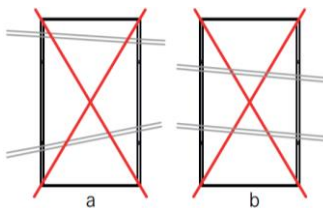

Fig. 4 Not permissible alignment of mounting profiles

a: Profiles not parallel to each other

b: Profile neither parallel nor perpendicular to the module edges

### 11.2 Clamp mounting for modules with standard frame

#### 11.2.1 Arranging the clamps

- Permissible clamp arrangement

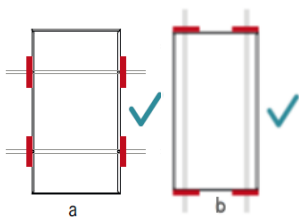

Fig. 5 Permissible clamp arrangement

a: Symmetrical clamping on long sides

b: Symmetrical clamping on the short sides

- Not permissible clamp arrangement

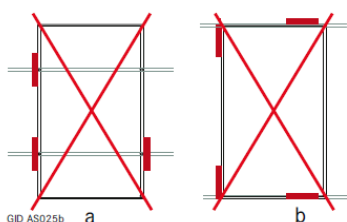

Fig. 6 Not permissible clamp arrangement (1)

a: Missing clamps

b: Clamping on both short and long sides

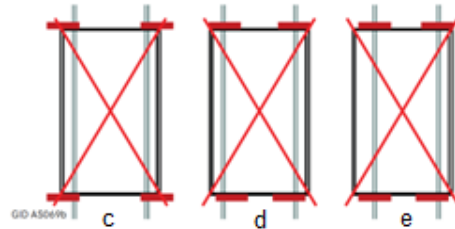

Fig. 7 Not permissible clamp arrangement (2)

c: Protruding clamps

d: Opposing clamps have different distances to the module corners

e: Asymmetrical clamps on the short side

#### 11.2.2 Clamp dimensions

Observe the following information for clamp lengths and depths.

- Clamp lengths and depths

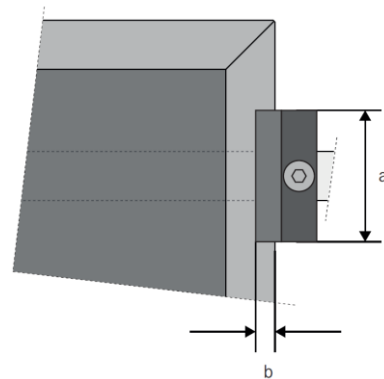

Fig. 8 Definition of clamp length and depth for framed modules

a: Clamp length

b: Clamp depth

#### NOTE

- The required minimum length of a clamp (parallel to the frame side) is 30 mm.
- The required minimum depth of a clamp (perpendicular to the frame side) is 3 mm.
- aleo solar recommends a clamp depth of 5 mm.
- Depending on the ambient conditions (e.g. angle, suction load or tolerances of the substructure) a higher minimum area per clamp may be required.
- Observe the instructions of the clamp manufacturer.

#### 11.2.3 Tightening torque for clamp mounting

Tighten the screws on the clamp manually. If you use an automatic screwdriver, then set a suitable maximum

tightening torque. You can find details for this in the manufacturer's documentation for the substructure.

### 11.3 Screw mounting

The aleo module types X61, X63, X81, X83 and P23 have mounting holes with a diameter of 9 mm. Use M8 screws for this

For M8 stainless steel screws, use a maximum torque of 24 Nm.<sup>7</sup>

The aleo module types LEO (L62 and L64) and LEO Black (L82 and L84) have a long hole 6.5 x 16 mm. Use M6 screws for this.

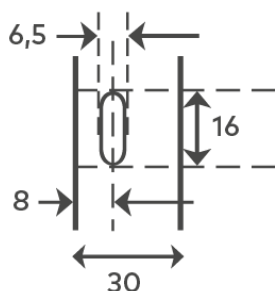

Fig. 1 Drawing long hole LEO series (40 mm frame height)

For M6 stainless steel screws, use a maximum torque of 9,9 Nm.<sup>8</sup>

### 11.4 Insertion mounting

Observe the manufacturer's instructions for the mounting system. Use the earthing holes for the potential equalisation.

Although edge-to-edge mounting is possible (see also chap. 8.4.1: „Intervals between modules with standard frame“), aleo solar recommends mounting at intervals.

### 11.5 Modules with Solrif® frame

Only mount modules with Solrif® frame with the Solrif® mounting system.

Please follow the instructions of the Ernst Schweizer for this mounting. These instructions can be found on the website of the Ernst Schweizer AG Metallbau or on the aleo website: [www.aleo-solar.com](http://www.aleo-solar.com).

## 11.6 Load levels

A load can be a pressure load as well as a suction load. Loads from snow and wind are grouped into several levels, which need to be considered wherever the module is installed. Higher load levels make the requirements for proper installation more stringent. The values listed below assume an appropriate installation (see chap. 10.7: “Mounting drawings for modules with standard frame”).

### 11.6.1 Permissible loads for modules with standard frame 42mm

Load level	Permissible pressure	Permissible suction
Load level I	2400 Pa	2400 Pa
Load level II	3900 Pa	2400 Pa
Load level III	5400 Pa	2400 Pa
Load level IV	8000 Pa	5400 Pa

### 11.6.2 Permissible loads for modules with standard frame 35mm

Load level	Permissible pressure	Permissible suction
Load level I	1400 Pa	1400 Pa
Load level II	3900 Pa	2400 Pa
Load level III	5400 Pa	2400 Pa

### 11.6.3 Permissible loads for modules with standard frame 40mm

Load level	Permissible pressure	Permissible suction
Load level I	1600 Pa	1600 Pa
Load level II	2400 Pa	2400 Pa
Load level III	5400 Pa	2400 Pa
Load level IV	8100 Pa	3600 Pa

### 11.6.4 Permissible loads for modules with Solrif® frame

Please observe the instructions from Schweizer for the mounting of modules with Solrif frame. You can find the manual on the website from Ernst Schweizer AG Metallbau or on aleo solar website:

[www.aleo-solar.com](http://www.aleo-solar.com).

<sup>7</sup> This applies to unlubricated screws with standard thread and strength class of 8.8 (minimum breaking load 29.2 kN).

<sup>8</sup> This applies to unlubricated screws with standard thread and strength class of 8.8 (minimum breaking load 29.2 kN).

### 11.6.5 Snow load

#### NOTE

For module types X61, X63, X81, X83 and P23:

For snow loads above 3900 Pa, suitable measures must be taken to ensure that slipping snow loads do not damage the lower module frame.

Possible measures are: snow hooks or module holder, in the middle of the lower frame part.



#### CAUTION!

These measures only serve as a support for the frame and not as an additional fastening point. Clamps fixing the frame are therefore not suitable for this purpose!

For the module types X61, X63, X81, X83 and P23:

For snow loads above 3900Pa, also recommends horizontal installation with clamping on the long side.

## 11.7 Mounting drawings for modules with standard frame

### 11.7.1 Module X63, X83

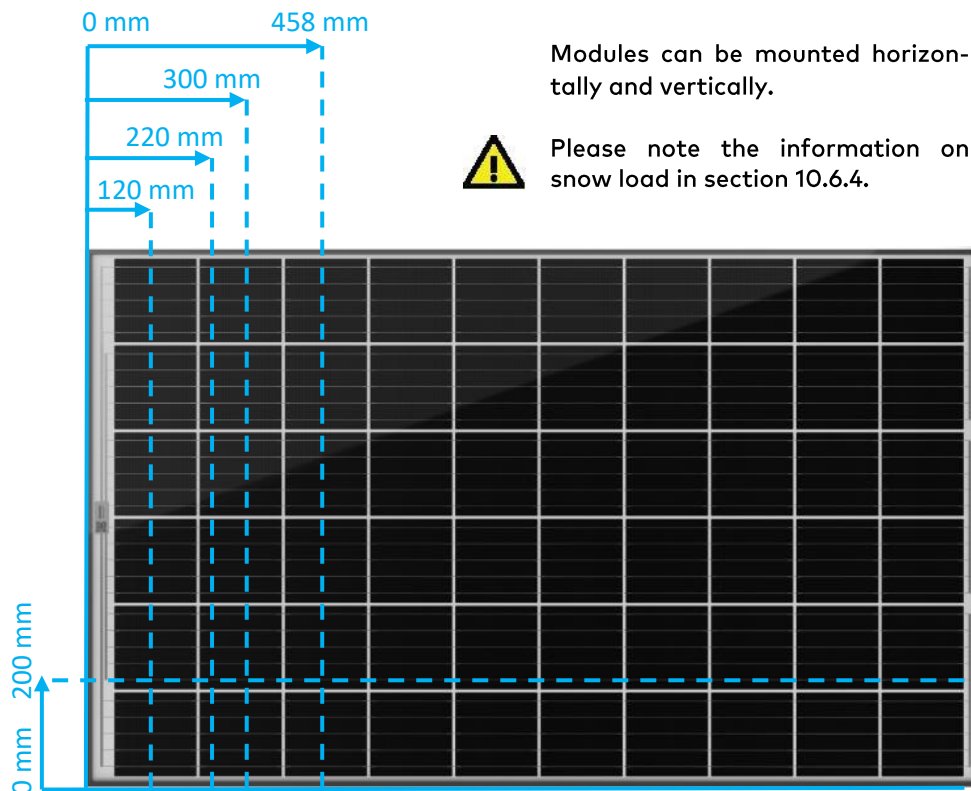

Fig. 10 Mounting X63/X83 with clamps

	Clamping area	Load level	Permissible pressure (test load)	Permissible suction (test load)
Clamping long side	0 mm – 458 mm	Load level I	2400 Pa	2400 Pa
	120 mm – 458 mm	Load level II	3900 Pa	2400 Pa
	220 mm – 458 mm	Load level III	5400 Pa	2400 Pa
	220 mm – 300 mm	Load level IV	8000 Pa	5400 Pa
Clamping short side	0 mm – 200 mm	Load level I	2400 Pa	2400 Pa

Table mounting areas clamping for X63, X83

	Load level	Permissible pressure (test load)	Permissible suction (test load)
Lay-in system long side	Load level II	3900 Pa	2400 Pa
Lay-in system short side	Load level I	2400 Pa	2400 Pa

Table lay-in system for X63, X83



### 11.7.2 Module X61, X81

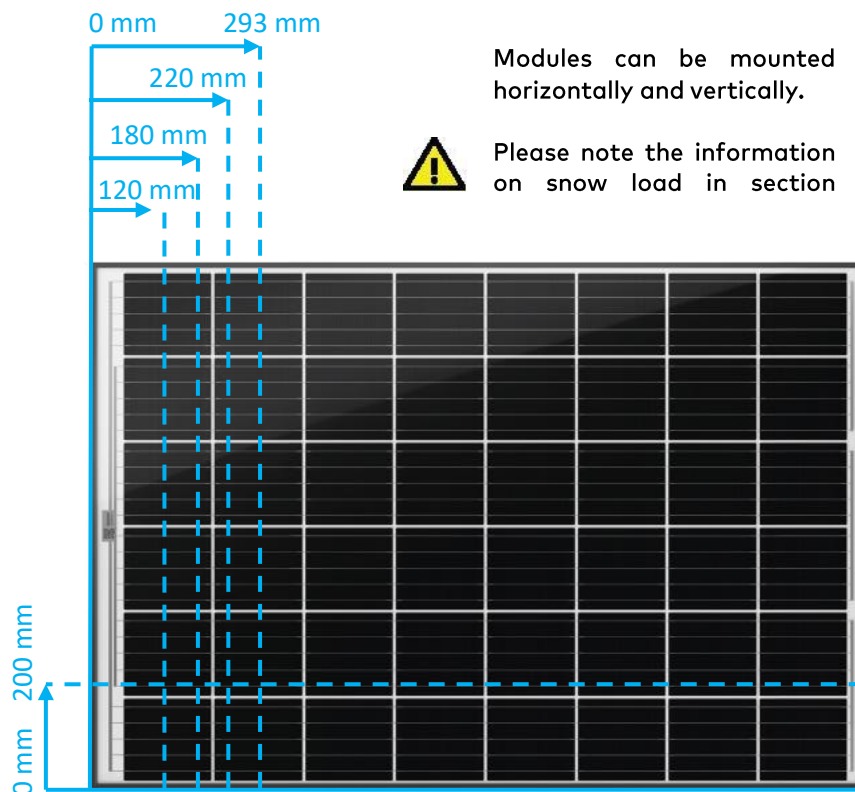

Fig. 11 Mounting X61/ X81 with clamps

	Clamping area	Load level	Permissible pressure (test load)	Permissible suction (test load)
Clamping long side	0 mm – 293 mm	Load level I	2400 Pa	2400 Pa
	120 mm – 293 mm	Load level II	3900 Pa	2400 Pa
	180 mm – 293 mm	Load level III	5400 Pa	2400 Pa
	180 mm – 220 mm	Load level IV	8000 Pa	5400 Pa
Clamping short side	0 mm – 200 mm	Load level I	2400 Pa	2400 Pa

Table mounting areas clamping for X61, X81

	Load level	Permissible pressure (test load)	Permissible suction (test load)
Lay-in system long side	Load level II	3900 Pa	2400 Pa
Lay-in system short side	Load level I	2400 Pa	2400 Pa

Table lay-in system for X61, X81

### 11.7.3 Module P23

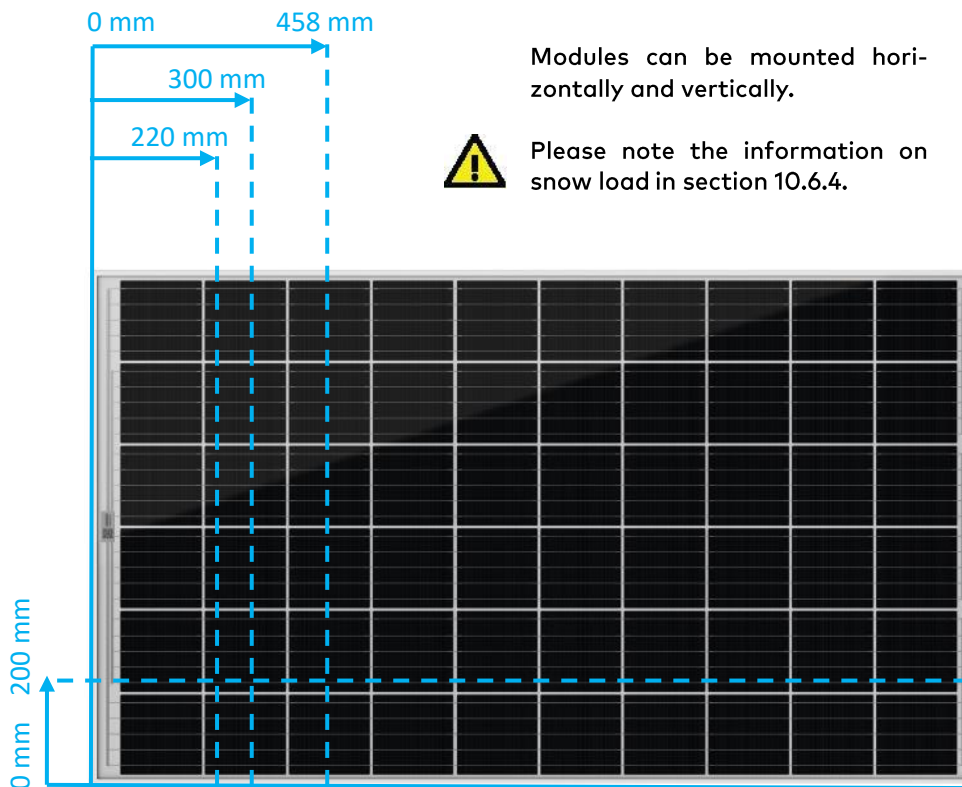

Fig. 12 Mounting P23 with clamps

	Clamping area	Load level	Permissible pressure (test load)	Permissible suction (test load)
Clamping long side	0 mm – 458 mm	Load level I	1400 Pa*	1400 Pa*
	220 mm – 458 mm	Load level II	3900 Pa	2400 Pa
	220 mm – 300 mm	Load level III	5400 Pa	2400 Pa
Clamping short side	0 mm – 200 mm	Load level I	1400 Pa	1400 Pa

Table mounting areas clamping for P23

	Load level	Permissible pressure (test load)	Permissible suction (test load)
Lay-in system long side	Load level I	2400 Pa	2400 Pa

Table lay-in system for P23

\* Based on IEC 61215

### 11.7.4 LEO (L64) / LEO Black (L84) – module with 108 half-cut cells



Abb. 2 Mounting LEO (L64) und LEO Black (L84) module with clamps

	Clamping area	Load level	Permissible pressure		Permissible suction	
			Test load	Design load	Test load	Design load
Clamping long side	0 mm – 426 mm	II	2400 Pa	1600 Pa	2400 Pa	1600 Pa
	230 mm – 426 mm	III	5400 Pa	3600 Pa	2400 Pa	1600 Pa
	230 mm – 300 mm	IV	8100 Pa	5400 Pa	3600 Pa	2400 Pa
Clamping short side	0 mm – 200 mm	I	1600 Pa*	1.067 Pa*	1600 Pa*	1.067 Pa*

Table mounting areas clamping for LEO (L64) und LEO Black (L84)

\* Based on IEC 61215

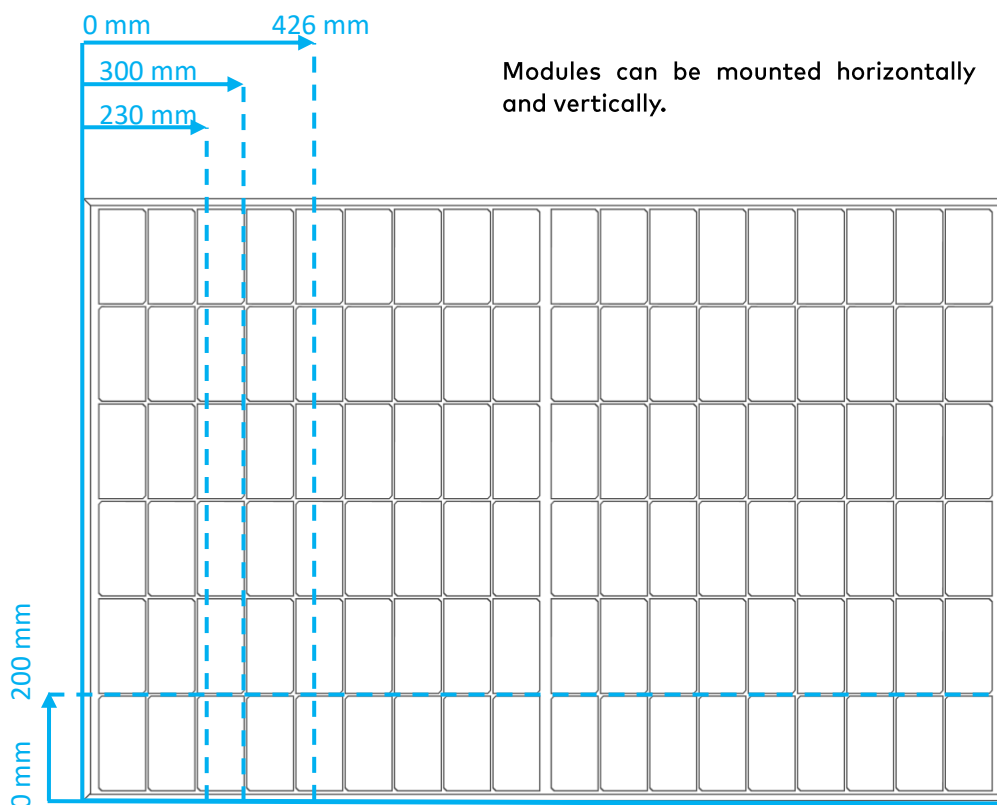
**11.7.5 LEO (L62) / LEO Black (L82) – module with 96 half-cut cells**



Abb. 3 LEO (L62) und LEO Black (L82) Modul with clamp

	Clamping area	Load level	Permissible pressure		Permissible suction	
			Test load	Design load	Testlast	Designlast
Clamping long side	0 mm – 332 mm	II	2400 Pa	1600 Pa	2400 Pa	1600 Pa
	200 mm – 332 mm	III	5400 Pa	3600 Pa	2400 Pa	1600 Pa
	200 mm – 270 mm	IV	8100 Pa	5400 Pa	3600 Pa	2400 Pa
Clamping short side	0 mm – 200 mm	I	1600 Pa*	1.067 Pa*	1600 Pa*	1.067 Pa*

Table mounting areas clamping for LEO (L62) and LEO Black (L82)

\* Based on IEC 61215

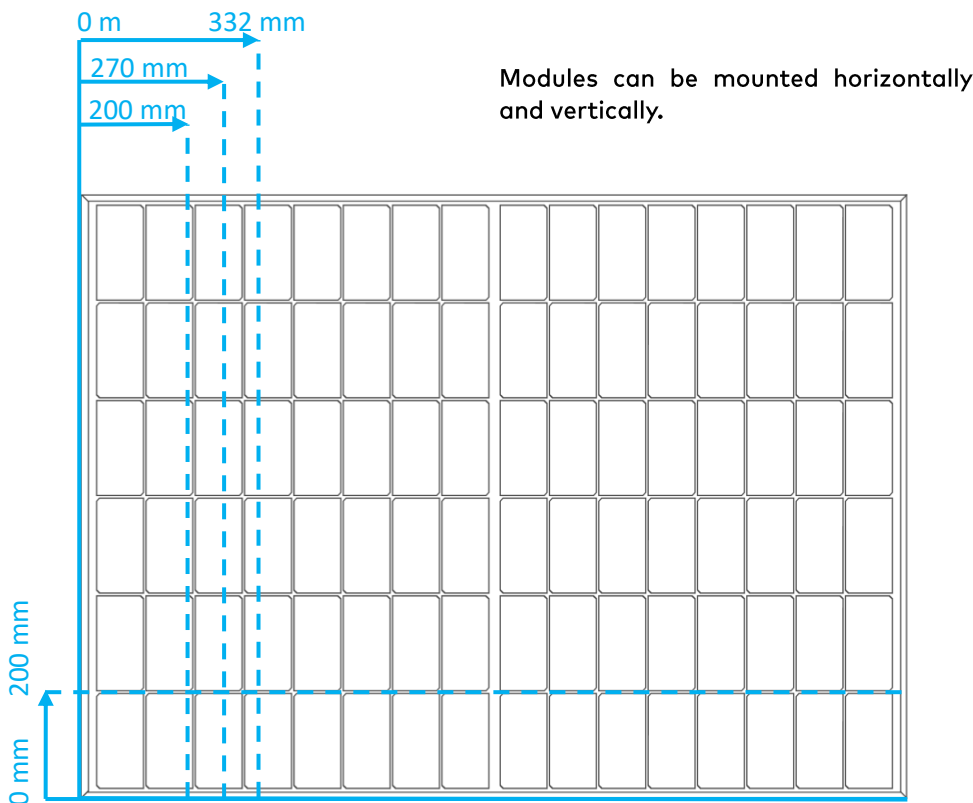
## 12 For operators: maintenance

### NOTE

Inspect and maintain your system to:

- keep it safe and reliable,
- achieve top output,
- prevent damage and,
- protect your investment.

aleo solar recommends carrying out regular inspections and maintenance so that any problems can be discovered reliably, and rectified.

### RECOMMENDATION

- aleo solar explicitly recommends annual inspections and a more thorough inspection and measurement every 4 years.
- We also recommend the use of a monitoring system to identify any outages or problems quickly.
- Inspecting the output of your photovoltaic system regularly can help to discover problems promptly, and ensures your photovoltaic system operates at top performance, preventing loss of output.
- For the proper maintenance and repair of your aleo solar photovoltaic system, contact your aleo solar dealer or get in touch with aleo solar directly (see chap. 2.2: „Contact“).

### 12.1 Inspection

aleo solar recommends an inspection every year. This should be a visual inspection. Refer to chap. 11.3: „Details for the inspections“.

The inspection includes the following aspects:

#### 12.1.1 Inspection of the generator

- strings: condition of the insulation and mounting,
- condition of the junction box,
- condition of the visible connectors,
- condition of the earthing conductors,
- for direct earthing: connection of the earthing conductors on the frames,
- for indirect earthing: connection of the frames to the sub-structure and the earthing conductors to the sub-structure,
- condition of the mounting system (in peripheral area),
- dirt on modules: type and degree of dirt. Clean the components, if necessary.
- shade circumstances (e.g. from trees or neighbouring houses).

#### 12.1.2 Inspection of the documentation and drawings

- check the module string plan,<sup>10</sup>
- check the inverter's status reports,
- determine and archive the annual output,
- create and archive the inspection report.

### 12.2 Review

aleo solar recommends carrying out a thorough review at least every 4 years. This includes the following work in addition to the inspection:

- measure the characteristics of individual strings (MPP current:  $I_{MPP}$ ; open-circuit voltage:  $U_{OC}$ ; power output:  $P_{MPP}$ ),
- measure the insulation resistance:  $R_{ISO}$ ,<sup>11,12</sup>
- evaluate the annual power output and compare the data with earlier readings,
- create and archive a review report.

### 12.3 Details for the inspections

#### 12.3.1 Mechanical inspection

- **Safety precautions:**  
Refer to the notes in chap. 6.2.2: „Mechanical safety precautions“.
- **Work steps:**  
During the inspection, check that the mechanical connections are clean, securely fitted and properly intact.

#### 12.3.2 Electrical inspection

- **Safety precautions:**  
Make sure you refer to the notes in chap. 6.2.1: „Electrical safety precautions“.
- **Work steps:**  
During the inspection, check that the electrical connections are clean, securely fitted and properly intact.  
Identify any defects or irregularities in the electrical installation and make a record of them. Then rectify the problem as quickly as possible.

### 12.4 Cleaning

Depending on the ambient conditions, modules are likely to get soiled more or less heavily over time. This can cause reduced output.

Dirt could be:

- dust, pollen or seed;
- leaves or twigs;
- deposits from stable vapour;

<sup>10</sup> Suggestion for external inspectors: perform a spot check to ensure that the module string plan matches the installation.

<sup>11</sup> According to the standard IEC 61215, a photovoltaic module should have an insulation resistance of at least 40 M $\Omega$ /m<sup>2</sup>.

<sup>12</sup> Some inverters provide the measured insulation resistance via an interface.

- moss, algae, fungi or bacteria growing on deposits (in short: biofilms);
- salt (in coastal regions).

#### 12.4.1 Safety precautions



#### CAUTION!

Contact of live parts with water: Risk of electric shock!

- Never use a high-pressure cleaner.

#### NOTE

You will also retain the manufacturer's warranty as a result of this measure.

#### 12.4.2 Glass surfaces

#### NOTE

The glass surfaces of aleo modules have microscopic structures or anti-reflex coatings. Ensure that these do not get damaged.

- Do not use any cleaning agents which will polish or scratch the surface.
- Avoid the use of very hard water.
- Also avoid the use of distilled or demineralised water if possible.<sup>13</sup>
- Avoid the use of acids, bases or other aggressive cleaning agents.

#### NOTE

Dirt- or water-repellent coatings subsequently applied to the modules can negatively affect the efficiency of the aleo modules and therefore the power output of the whole photovoltaic system. We therefore advise against the use of these agents.

### RECOMMENDATION

For cleaning the glass module surfaces, aleo solar recommends:

- rainwater without additives<sup>14</sup> with its temperature matching the temperature of the module<sup>15</sup>;
- a soft sponge or a soft brush.

<sup>13</sup> Distilled or demineralised water is often used by cleaning services but can damage glass surfaces with frequent intensive use over long periods of time. aleo solar therefore advises against the use of distilled or demineralised water.

<sup>14</sup> Rainwater has a low level of water hardness. It is beneficial to use it because a build-up of deposits is avoided.

<sup>15</sup> This prevents mechanical tension in the glass and ensures the module a longer service life.

If necessary, use a telescopic rod with a sponge or soft brush attached on the end. The rod can have a water pipe integrated.

For stubborn patches of dirt, use the following to help:

- Isopropanol:

aleo solar recommends a mixture of isopropanol and rainwater to the ratio of 1:1.

- Glass cleaner:

As an alternative, aleo solar recommends clear, colourless glass cleaner without ethanol or denaturants (e.g. Bitrex®).<sup>16</sup>

- Anti-reflex glass

aleo modules have an anti-reflex layer on the glass surface to achieve a higher output. This means that some marks (e.g. fingerprints) are more visible than on normal glass. These marks are mostly seen as shimmering patches.

These kinds of marks do not have any measurable effect on the module output and fade away after about 2 weeks of being exposed to weather conditions, as sunlight and rain break them down.

#### 12.4.3 Insulating back sheet

The insulating back sheet must not be cleaned. Nevertheless, if you still need to perform work behind the modules (e.g. to remove leaves):

- Make sure you refer to chap. 6.2.1: „Electrical safety precautions“ and chap. 6.2.2: „Mechanical safety precautions“.
- Avoid damaging the insulating back sheet.

#### 12.4.4 More frequent cleaning

### RECOMMENDATION

- In environments subject to heavy soiling, we recommend making the intervals for inspections and cleaning shorter than just once a year.
- For example, this applies to environments with a high exposure to dust, especially close to:
  - large livestock farms,
  - grain reloading stations,
  - green areas with heavy foliage, seeds or pollen or
  - factories with high levels of dust emission.

<sup>16</sup> Distilled or Ethanol contains denaturants. Some denaturants can leave streaks behind or damage an anti-reflex layer.

If frequent cleaning is necessary, aleo solar recommends contracting a specialised company to clean your photovoltaic generator properly without treading on the modules.

## 12.5 Repairs

### 12.5.1 Modules

For repairing aleo modules, only contract technicians who have been authorised by aleo solar to avoid loss of warranty.

A defective module can cause loss of output, as well as consequential damage. If an aleo module needs repairing, first get in touch with aleo solar (see chap. 2.2: „Contact“). Never, under any circumstances, repair an aleo module yourself.

Improper repairs can cause damage which may have repercussions years later, such as failure of electrical insulation. This could be fatal. Therefore, report any necessary repairs immediately.

Before you carry out any maintenance work on aleo modules, deactivate the module string or the whole generator if necessary. Observe the warnings and notes in chap. 6.2.2: „Mechanical safety precautions“ and chap. 6.2.1: „Electrical safety precautions“.

### 12.5.2 System parts

For repairing other system parts (e.g. substructure, connection boxes), contract authorised technicians to do the work or contact aleo solar directly (see chap. 2.2: „Contact“).

## 13 For operators: decommissioning

### 13.1 Safety precautions

Make sure you refer to the notes in chap. 6.2.1: „Electrical safety precautions“. If you would like to continue using the aleo module, also refer to chap. 7.1: „Handling aleo modules“.

### 13.2 Disposal

#### NOTE

- Dispose of the aleo modules at the end of their service life in the proper manner.
- To do this, contact a disposal company.
- Never dispose of aleo modules with household waste.

### 13.3 Returns

aleo solar is member of PV Cycle. Used or damaged PV modules from aleo solar are disposed of by PV Cycle without any costs. Under certain circumstances transport costs may apply in the context of disposal.

### 13.4 PV Cycle

PV CYCLE offers a comprehensive collection network for PV module waste, from fixed collection points to on-site pick-up.

Please contact [operations@pvcycle.org](mailto:operations@pvcycle.org) for your individual disposal solution.

**Aleo solar GmbH**

Marius-Eriksen-Straße 1  
17291 Prenzlau  
Germany

**Contact**

+49 (0)3984-8328-0  
[info@aleo-solar.com](mailto:info@aleo-solar.com)  
[www.aleo-solar.com](http://www.aleo-solar.com)

**aleo**