

Installation, use, maintenance manual

DualSun FLASH

Table of Contents

1. Introduction	3
1.1. General safety instructions	3
1.2. General standards to be observed	3
1.2.1. Photovoltaic solar standards	4
1.3. Solar thermal standards	4
2. General description	5
2.1. Technical characteristics	5
2.2. General recommendations	5
2.2.1. Handling	5
2.2.2. Transport	5
2.2.3. Storage	5
2.3. Technical considerations	5
2.3.1. Angle of inclination	6
2.3.2. Wind and snow load	6
2.3.3. System location	6
2.3.4. Types of mounting	6
2.3.5. Protection against fire / explosion	7
3. Mechanical installation	8
3.1. Installing DualSun modules	8
3.2. Assembly specifications	10
3.2.1. Installation areas on the rails of the mounting system	10
3.2.2.	23
4. Electrical Installation	25
4.1. Electrical connection	25
4.2. Position of the micro inverter for the FLASH 425 and the SPRING 425	26
4.3. Electrical fittings, cables and diodes	27
4.4. Bonding and lightning protection	28
4.5. Indirect lightning strike	28
5. Cleaning the surface of the modules	30
6. Decommissioning of the installation	31
6.1. Removing a module	31
6.2. Waste treatment	31
7. Responsibilities	32
7.1. Guarantee conditions	32
7.2. Disclaimer	32

1. Introduction

1.1. General safety instructions

Please read this installation manual thoroughly and in detail in order to be able to fully exploit the functionality of the product. DualSun disclaims all liability for defetcs and damages that would result from non-compliance with the installation instructions (improper use, incorrect installation, handling error, etc.).



IMPORTANT

- It is important to follow these instructions for personal safety. Improper mounting may cause serious injury. The end user must keep these safety instructions.
- The installation, control, commissioning, maintenance and repair of the installation must only be carried out by qualified personnel.
- The correct functioning of the installation is only guaranteed if the installation and assembly have been carried out in accordance with the rules of the art.



CAUTION

- The entire solar installation must be installed and operated in accordance with recognized technical rules.
- All electrical work must be done according to local guidelines.
- The installation must not be used if it shows signs of damage.



DANGER

- For installations on roofs, it is necessary to comply with personal safety standards, relating to roofing and waterproofing work and relating to scaffolding work with safety net by mounting the respective devices before starting work . Refer to the recommendation published by the national risk prevention organization.
- Gloves are compulsory when handling the panels to avoid any risk of injury or burns.
- Disconnect all connection cables from the power supply before working on the installation.

1.2. General standards to be observed

To ensure safe, ecological and economical operation, all applicable regional and national standards, rules and directives must be observed, particularly the international standards mentioned below:

1.2.1. Photovoltaic solar standards

- CEI / EN 61215 1 and 2: Design qualification and approval of crystalline silicon photovoltaic (PV) modules for terrestrial application.
- CEI / EN 61730 1 and 2: Qualification for dependability of photovoltaic (PV) modules - part 1: Requirements for construction and part 2: requirements for tests.

The installation instructions and safety instructions must be met.

Observe the regulations on the prevention of industrial accidents prescribed by professional associations, in particular those relating to work carried out on the roof.

1.3. Solar thermal standards

FLASH and SPRING DualSun panels must be recycled

2. General description

2.1. Technical characteristics

The technical characteristics of the DualSun panels can be found in the technical sheets published in our [online library](#)

2.2. General recommendations

2.2.1. Handling

DualSun modules should be handled like any glass product. To avoid accidents, injuries, or damage to the module during work, the following precautions must always be observed:

- Do not step on the modules.
- Do not drop anything on the modules.
- Protect the modules from possible scratches on the front and rear sides
- Do not exert mechanical tension on the connectors.
- Always lift and transport the modules with both hands and never use the junction box as a carrying handle.
- Never press on the exchanger part of the panel, you would damage it.

2.2.2. Transport

In order not to risk damaging the modules during transport, the following instructions must be observed:

- Transport the stacked modules vertically, with a separator supported by the frame of each module.
- Do not remove the original packaging until the time of installation.
- Do not apply mechanical pressure to the modules (for example, do not fasten the modules with a strap, or else do not place any object on the surface of the modules).

2.2.3. Storage

During storage, to avoid any accident or damage to the modules, the following instructions must be observed:

- Store the modules vertically.
- Do not store modules on the edges, on a corner, or on an uneven surface.
- Do not place any object on the surface of the modules.
- When choosing a suitable storage location, make sure that:
 - The location is dry and cool,
 - No object can fall on the module and thus damage it.



WARNING

If a DualSun module is damaged or broken, it must be replaced. Never install a damaged module.

2.3. Technical considerations

Throughout the year, the system is exposed to external weather and natural conditions (sun, wind, rain, hail, snow, thunderstorms, dead leaves, dust, bird droppings, etc.) which influence the performance and service

life of the modules. To extend the service life of the modules and ensure proper operation of the installation, important factors and adjustment parameters must be considered:

2.3.1. Angle of inclination

The optimal mounting position of the DualSun solar panels corresponds to an angle of incidence of the sun's rays of 90 ° relative to the surface of the panels (i.e. perpendicular to the panels). To optimize the output of the installation, the panels must be installed with the optimal orientation and angle of inclination. These positioning angles depend on the geographic location of the installation and can be calculated by a qualified solar installer. Wherever possible, the panels of a group must have the same orientation and the same inclination in order to avoid any underperformance of the system due to inconsistent productions.

DualSun recommends a minimum tilt angle of 5 ° from the horizontal to reduce the clogging effect.

The cleaning frequency should be increased for modules installed with a very low angle of inclination from the horizontal.

2.3.2. Wind and snow load

The module has been tested up to a pressure of **5400Pa** in positive pressure (snow) and **2400Pa** under negative pressure (wind) without damage under standard assembly conditions: 4 brackets along the long side (see chapter "Laying area on the rails of the installation system"). Some models have been tested up to 6600Pa in negative pressure and 3600Pa in positive, refer to the table "installation area on the rails". It therefore meets the requirements of the IEC/EN 61215 standard for wind speeds of up to 130 km/h.

2.3.3. System location

The overall yield of the photovoltaic system in series is always limited by the module delivering the lowest power. Different factors can influence the performance of a module (shading, different orientations, fouling ...) and these impact the entire system.

Therefore, it is necessary to study the layout to avoid a shading effect on the modules in series.

In addition, all panels must be mounted with the same orientation. It is advisable to align all the modules to the solar noon, to obtain optimal performance.

DualSun suggests installing the modules in areas where **temperatures are between -20°C and +40°C**, which corresponds to the minimum and maximum monthly average temperatures, **in accordance with IEC 60364-5-51**. The extreme operating temperatures of the modules are between -40°C and +85°C.

In regions with heavy snow cover and exposed to strong winds, the modules must be mounted in such a way as to ensure sufficient nominal resistance and in accordance with local regulations.

Certain operating environments are not recommended for DualSun modules, and **are excluded from the DualSun Limited Warranty**:

- No panel should be mounted on a site where it may be exposed to direct contact with :
 - salt water
 - acid rain
 - active chemical vapors or any other aggressive environment
- DualSun modules must not be installed near flammable liquids, gases, hazardous materials or on any type of vehicle.
- It is recommended to install the photovoltaic modules at altitudes below 2000 m

2.3.4. Types of mounting

The fixing of the modules must be done at least in 4 points distributed on the planned zones specified in the paragraph [Installation areas on the rails of the mounting system](#)

In-roof assembly

This assembly guarantees the retention of the original functionality of the roof. Special attention should be paid to the insulation as well as to the protection against rain and humidity. To achieve this level of sealing, the module must be mounted on a special frame that can route rainwater and withstand the wind and snow loads occurring in the geographical area of the installation.

On-roof assembly

The modules can be mounted on a frame designed to support the photovoltaic panels. This framework must be able to withstand the wind and snow loads occurring in the geographical area of the installation. When fastening and connecting the system to the building, it is necessary to avoid damage or destruction of the roof covering in order to maintain optimum resistance against rain and moisture.



WARNING

The instructions given in the installation guide for the mounting system must be followed for proper installation.

2.3.5. Protection against fire / explosion

Do not install the DualSun modules in the vicinity of highly flammable gases, vapours, or dust (e.g., next to a gas station or containers). The national and local fire prevention standards and regulations must be respected during installation. For installations located on a roof, the modules must be mounted on a fire-resistant roofing cover adapted to the application.

The photovoltaic (PV) module, component of the module (PVT) has a class C fire resistance according to CEI/EN 61730-2.

3. Mechanical installation



CAUTION

The management and installation of DualSun panels and the equipment making up the complete installation must be carried out by trained and qualified personnel. The system must be assembled and operated in accordance with the instructions provided, in accordance with the local and national health and safety, and risk prevention regulations.

During assembly and operation of the system, no unauthorized person may be on the roof or around the installation.

3.1. Installing DualSun modules

The DualSun FLASH and SPRING panels can be installed both in portrait and landscape.

DualSun does not provide the module fixing system: for proper installation, refer to the installation instructions for the chosen fixing system.



NOTE

The list of mounting systems compatible with DualSun modules is available in the "Mounting systems compatibility" document in our [online library](#)



CAUTION

Even when solar radiation is low, the photovoltaic system produces direct current (DC). This DC current flows from the module to the inverter, do not handle the module or connections without protection.

The modules are qualified for use in class II and comply with standards IEC / EN 61215-2 and IEC / EN 61730-1. These standards concern PV modules for use on buildings, or on ground structures.

Artificially concentrated solar radiation must not be directed onto the module.

The frame thickness and the dimensions of the SPRING panel are identical to photovoltaic panels. It adapts easily to photovoltaic mounting systems; however, it is necessary to ensure the positioning of the hoses in relation to the mounting system frame and to the roof covering surface.

The mounting system must have a flat surface for mounting the panel and must not cause twisting or stress on the panel, even in case of thermal expansion.

We also remind that the waterproofing of the roof is not ensured by the panels but by the panels mounting system and that the drainage must be provided.

It is necessary to provide a space between the frame of the panels and the structure or the floor to avoid damage to the cables and hydraulic fittings.

The panel mounting systems must be installed only on buildings that have been formally validated for structural integrity, and which have been considered capable of supporting the additional weight of the panels and mounting systems, by a certified building specialist or engineer.

The supplier of the mounting system must take into account the galvanic corrosion which may appear between the aluminium frame of the panels and the mounting system or the grounding parts if they are made of different metals.

The module is only certified when its original frame is completely intact. Do not remove or modify the module frame in any way. Drilling additional mounting holes is likely to damage the module and reduce the strength of the frame, and thus is not allowed.

The use of flanges and fasteners with additional grounding bolts or grounding connectors shall be in accordance with this safety and installation instruction manual and according to the conditions of [Bonding and lightning protection \[28\]](#).

The modules can be installed according to the following methods:

1. **Frame holes:** Attach the module to the structure using the factory-made mounting holes. It is recommended to use four M8x16 mm stainless steel screws with bolts, washers and lock washers for each module. The maximum tightening torque of the bolts is 24 N.m.



CAUTION

This method is only valid on the FLASH photovoltaic panel range. It is therefore not valid for our range of hybrid panels.

2. **Calipers or clamps :** the brackets can be mounted on the longitudinal (longest side) or lateral (shortest side) side of the module. The areas allocated to these clamps are specified in [Installation areas on the rails of the mounting system \[10\]](#).

When installing the clamps, please consider the following measures:

- Do not bend the frame of the module.
- Do not touch the glass or cast shadows on the front glass.
- Overlap in depth of the clamps on the frame: between 7mm and 12 mm
- Minimum clamps width: 50mm.
- Minimum Clamps thickness: 3mm

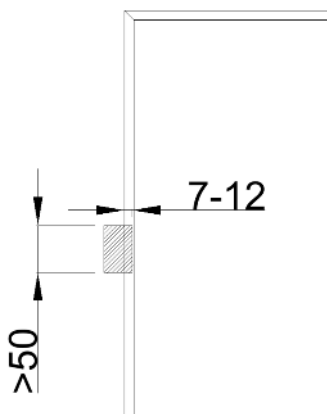

Installers must ensure that the resistance of the clamps is sufficient given the maximum pressure to which the module can be exposed. The clamps are not supplied by DualSun.



IMPORTANT

It is important to make sure that the clamping brackets do not distort the top of the aluminium frame of the DualSun panel, this may weaken or even break the glass.



CAUTION

The tightening torque of the clamps must not exceed 24 N.m.



WARNING

The compatibility of the mounting system with the modules must be assessed before any installation, especially when the system does not use brackets or clamps.

3.2. Assembly specifications



[Installation areas on the rails of the mounting system \[10\]](#)

3.2.1. Installation areas on the rails of the mounting system

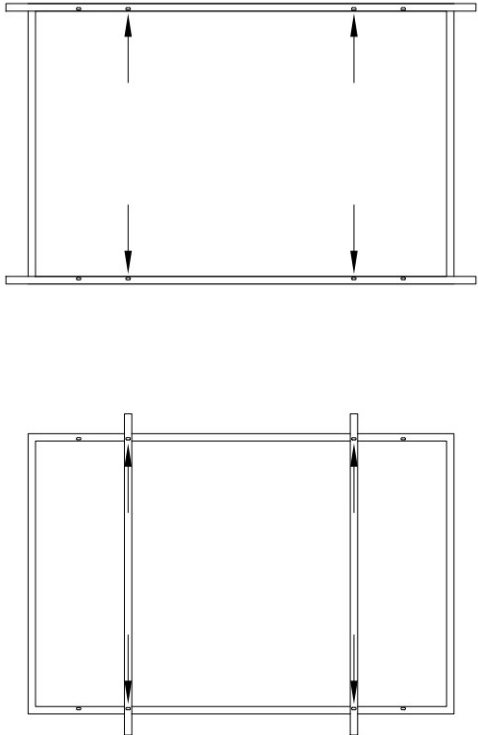

DualSun panels are **certified according to the IEC standard** for a maximum mechanical load of 5400 Pa positive (snow) and -2400 Pa negative (wind) in a **standard configuration with four stirrups along the long side**. The maximum design load is 3600/-1600Pa).

For details of the charges depending on the installation methods, please consult the table below. The technical name of your panel can be found on the technical sheet.

All dimensions specified in this table are in mm.

Panels: DSxxx-132M10-01; DSxxx-132M10B-01		
Installation method	4 bolts in the mounting holes on the long side	4 clamps on the short side
Installation		
Position of clamps		$0 < H < 1/4 * W$
Maximum test load not included in IEC 61730 certification	3600Pa positive, 2400Pa negative	2400Pa positive, 1600Pa negative

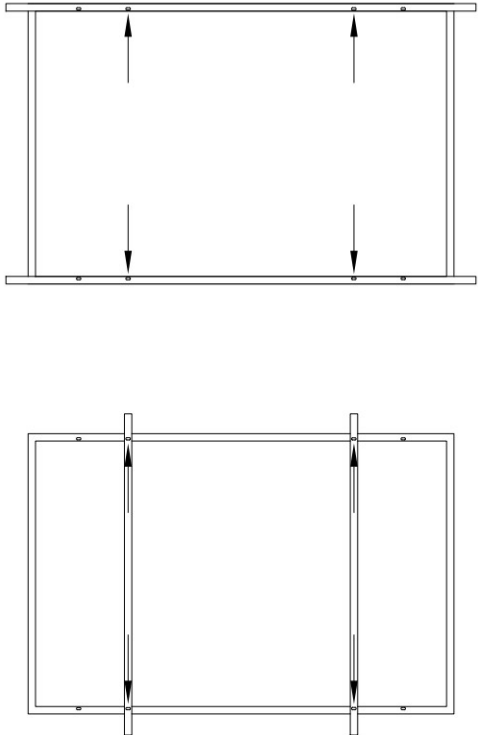
Panels: DSxxx-132M10-01; DSxxx-132M10B-01		
Installation method	4 clamps on the long side	6 clamps on the long side
Installation		
Position of clamps	$(1/5 * L - 50) < S < (1/5 * L + 50)$	$(1/2L - 80) < S < (1/2L - 30) ; (1/6L - 50) < H < (1/6L + 50)$
Maximum test load not included in IEC 61730 certification	5400Pa positive, 2400Pa negative	5400Pa positive, 3600 negative

DSxxx-108M10-02 ; DSxxx-108M10B-02 ;DSxxx-108M10TB-03		
Installation method	4 bolts in the mounting holes on the long side	4 clamps on the short side
Installation		
Position of clamps		$0 < H < 1/4 * W$
Maximum test load not included in IEC 61730 certification	5400Pa positive, 2400Pa negative	2400Pa positive, 1600Pa negative

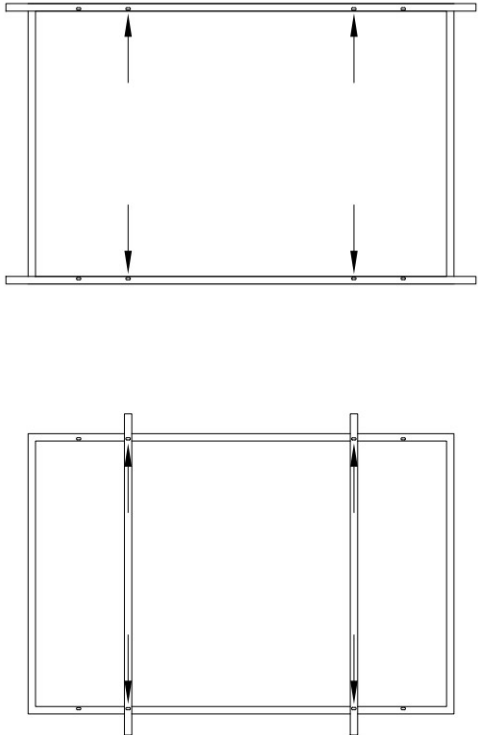
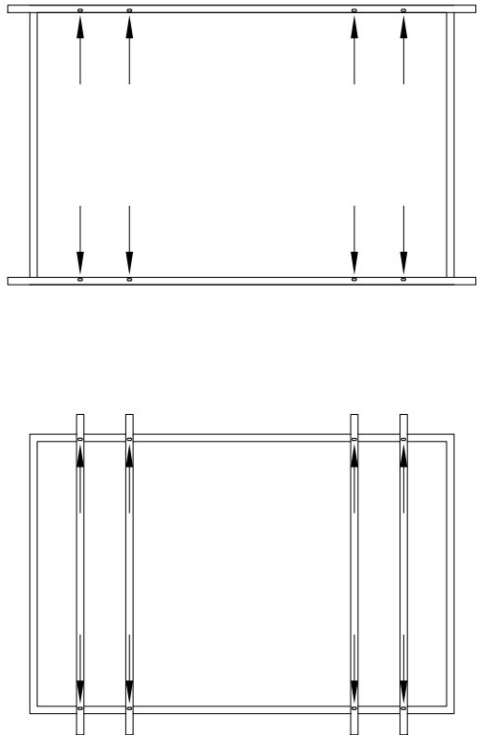

DSxxx-108M10-02		
Installation method	4 clamps on the long side	6 clamps on the long side
Installation		
Position of clamps	$(1/5 * L - 50) < S < (1/5 * L + 50)$	$(1/2L - 80) < S < (1/2L - 30) ; (1/6L - 50) < H < (1/6L + 50)$
Maximum test load not included in IEC 61730 certification	5400Pa positive, 2400Pa negative	5400Pa positive, 3600 negative

DSxxx-108M10B-02 ; DSxxx-108M10TB-03		
Installation method	4 clamps on the long side	6 clamps on the long side
Installation		
Position of clamps	$(1/5 * L - 50) < S < (1/5 * L + 50)$	$(1/2L - 80) < S < (1/2L - 30) ; (1/6L - 50) < H < (1/6L + 50)$
Maximum test load not included in IEC 61730 certification	6600Pa positive, 3600Pa negative	6600Pa positive, 3600Pa negative

DSxxxM2-60BB-02 ; DSxxxM6-120SW-01 ; DSxxx-120M6-02 ; DSxxx-120M6-02-V ; DSxxx-120M6B-02		
Installation method	4 bolts in the mounting holes on the long side	8 bolts in the mounting holes on the long side
Installation		
Maximum test load not included in IEC 61730 certification	5400Pa positive, 2400Pa negative	5400Pa positive, 3600 negative

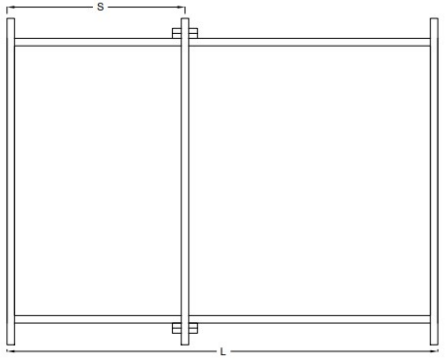
Panels: DSxxxM2-60BB-02; DSxxxM6-120SW-01; DSxxx-120M6-02; DSxxx-120M6-02-V; DSxxx-120M6B-02		
Installation method	4 clamps on the long side	6 clamps on the long side
Installation		
Position of clamps	$(1/4L-50) < S < (1/4L+50)$	$(1/2*L-80) < S < (1/2*L-30) ;$ $(1/6*L-50) < H < (1/6*L+50)$
Maximum test load not included in IEC 61730 certification	5400Pa positive, 2400Pa negative	5400Pa positive, 3600 negative

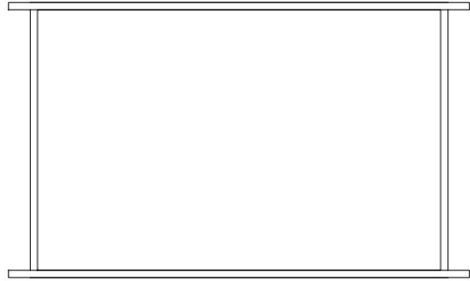

Panels: DSxxxM2-60BB-02; DSxxxM6-120SW-01; DSxxx-120M6-02; DSxxx-120M6-02-V; DSxxx-120M6B-02		
Installation method	4 clamps on the short side	Rail installation on the short side with clamps reinforcement on the long side
Installation		
Position of clamps	$0 < H < 1/4 * W$	$(1/2 * L - 80) < S (1/2 * L - 30)$
Maximum test load not included in IEC 61730 certification	2400Pa positive, 1600Pa negative	5400Pa positive, 2400Pa negative

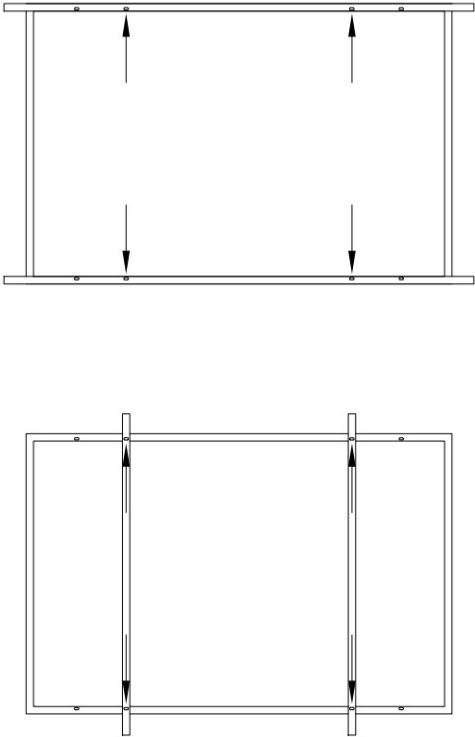
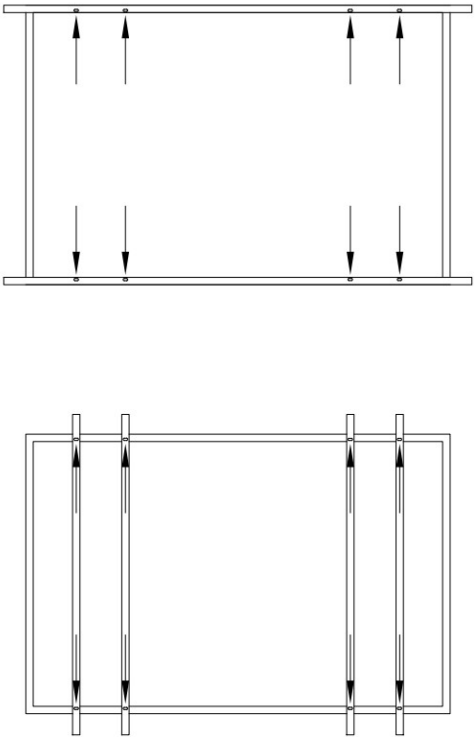

Panels: DSxxxM2-60BB-02; DSxxxM6-120SW-01; DSxxx-120M6-02; DSxxx-120M6-02-V; DSxxx-120M6B-02		
Installation method	Rail installation on the long side	Rail installation on the short side
Installation		
Maximum test load not included in IEC 61730 certification	5400Pa positive, 2400Pa negative	2400Pa positive, 1600Pa negative

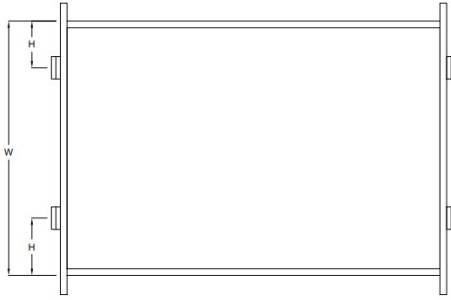
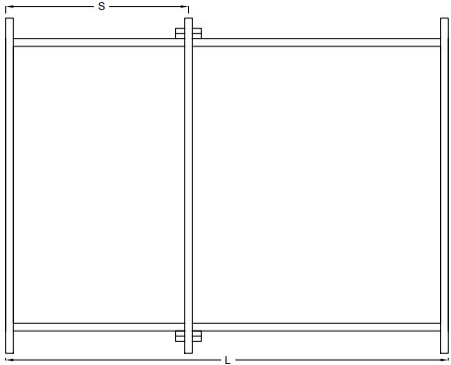
DSxxxM6-144BB-01		
Installation method	4 bolts in the mounting holes on the long side	8 bolts in the mounting holes on the long side
Installation		
Maximum test load not included in IEC 61730 certification	3600Pa positive, 2400Pa negative	5400Pa positive, 3600Pa negative

Panels: DSxxxM6-144BB-01		
Installation method	4 clamps on the long side	6 clamps on the long side
Installation		
Position of clamps	$(\frac{1}{4} * L - 50) < S < (\frac{1}{4} * L + 50)$	$(\frac{1}{2} * L - 80) < S < (\frac{1}{2} * L - 30) ;$ $(\frac{1}{6} * L - 50) < H < (\frac{1}{6} * L + 50)$
Maximum test load not included in IEC 61730 certification	5400Pa positive, 2400 negative	5400Pa positive, 3600 negative

Panels: DSxxxM6-144BB-01		
Installation method	4 clamps on the short side	Rail installation on the short side with clamps reinforcement on the long side
Installation		
Position of clamps	$0 < H < 1/4 * W$	$(1/2 * L - 80) < S < (1/2 * L - 30)$
Maximum test load not included in IEC 61730 certification	1600Pa positive, 1600Pa negative	5400Pa positive, 2400Pa negative

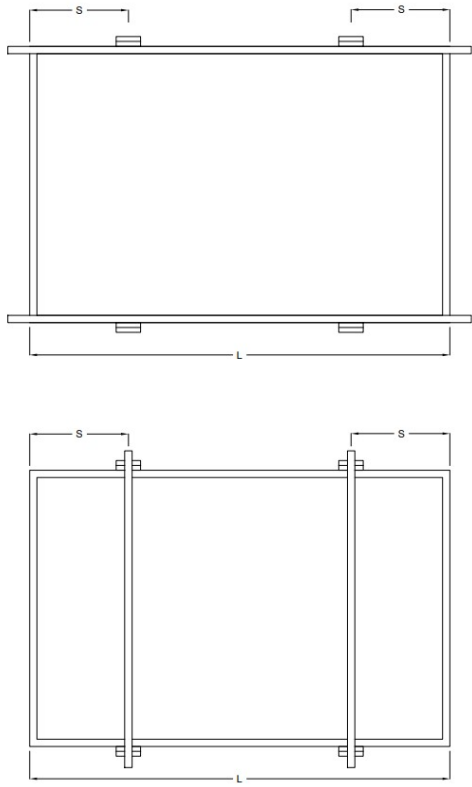
Panels: DSxxxM6-144BB-01		
Installation method	Rail installation on the long side	Rail installation on the short side
Installation		
Maximum test load not included in IEC 61730 certification	5400Pa positive, 2400Pa negative	1600Pa positive, 1600Pa negative

DSxxxM12-B320SBB7 ; DSxxxG1-360SBB5		
Installation method	4 clamps on the long side	4 clamps on the short side
Installation		
Position of clamps	$330 < S < 430$	$0 < H < 300$
Maximum test load not included in IEC 61730 certification	5400Pa positive, 2400Pa negative	2400Pa positive, 2400Pa negative

Panels: DSxxxM12-B320SBB7 ; DSxxxG1-360SBB5		
Installation method	6 clamps on the long side	
Installation		
Position of clamps	$(L/2 - 50) < S < (L/2 + 50)$; $50 < H < 100$	
Maximum test load not included in IEC 61730 certification	6000Pa positive, 3000Pa negative	



NOTE

Some roofs require a bracket fixing range of 333 mm on the long side. In this case, installation is authorized and the maximum authorized load values change as follows:

Table 1.

Maximum load certified for a range of 100 mm	Maximum certified load for 333 mm range
6600Pa positive, 3600Pa negative	5400Pa positive, 2400Pa negative
Other values	2400Pa positive, 1600Pa negative



CAUTION

Do not interface the rails of the laying system with the hydraulic connections, the areas of which are delimited in the plan above.



WARNING

No element fixed on the rails can be in contact with the rear face of the panel. For example micro-inverter or optimizer.

Use a mechanical mounting element suitable for the rails of the installation system to fix the micro-inverter or the optimizer in such a way as to ensure a minimum gap of 19 mm between the roof and the micro-inverter or optimizer and of 13 mm between the back of the SPRING module and the top of the microinverter or optimizer. See assembly example below:

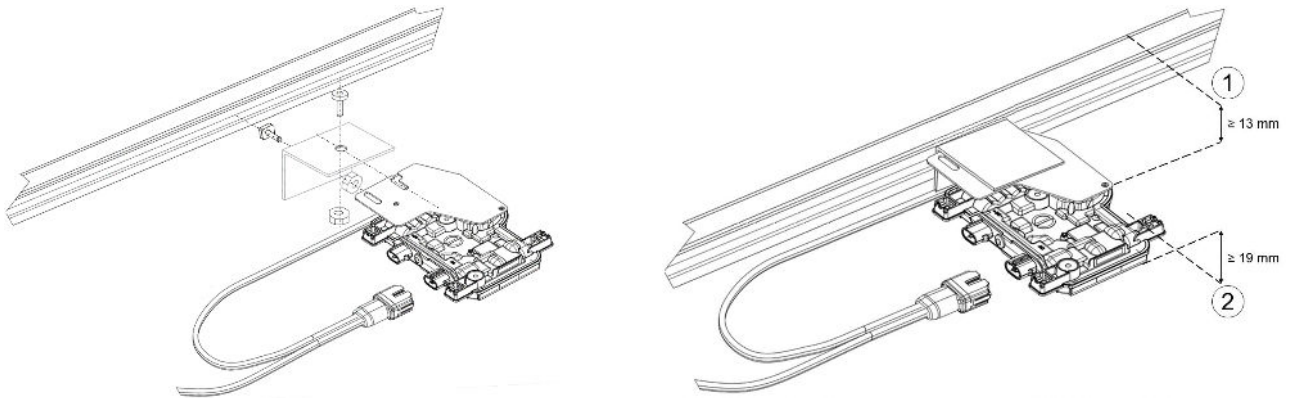

1. Bottom frame edge of SPRING panel
2. Roof

4. Electrical Installation

Electrical connection [25]

Electrical fittings, cables and diodes [27]

Bonding and lightning protection [28]

Indirect lightning strike [28]

4.1. Electrical connection

The nominal electrical parameters I_{cc} , V_{co} and P_{max} of the modules are determined under standard STC (Standard Test Condition) test conditions: illuminance of 1000 W/m^2 with a spectrum of 1.5 AM and a cell temperature of 25°C . These values can vary by $\pm 3\%$ for power and $\pm 4\%$ for I_{sc} and V_{oc} .



NOTE

Under normal conditions, a photovoltaic module is likely to be exposed to conditions which produce more current and / or voltage than what is measured under standard test conditions. Therefore, **the maximum values of I_{SC} and V_{OC} noted on the module should be multiplied by 1.25 when determining the rated voltage of the components, the nominal current of the conductors, the size of the fuses, and the size of the control tools connected to the PV output**

Wiring in series

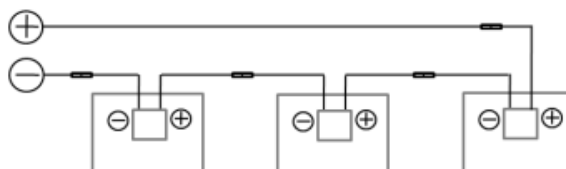

Wiring in parallel

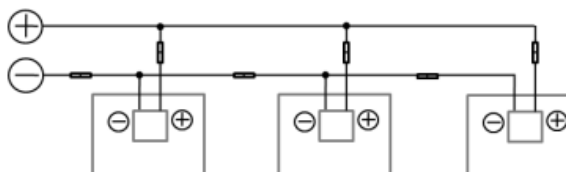

Serial / parallel wiring

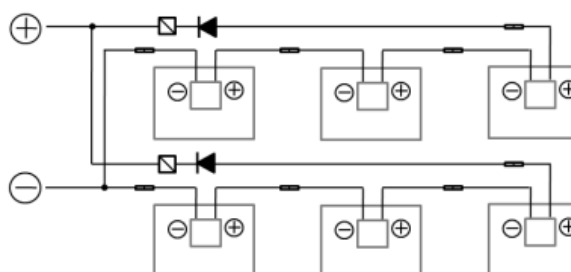

Diode



Overcurrent protection



Connector

1. Wiring in series

To wire modules in series, the maximum number of connectable modules must be determined. For this it is necessary to determine the maximum voltage of the string. This is calculated by adding the open

circuit voltage (V_{OC}) of each module when the ambient temperature is at its minimum value. Apply the temperature coefficient to know the V_{OC} value at the temperature considered.

The maximum open circuit voltage of the string should never exceed the maximum system voltage.
See [module data sheet](#).

Determination of the maximum number of modules that can be connected in series:

$$N = \text{Maximum_system_voltage} / (1.15 * V_{OC})$$

Where:

- N = Maximum number of modules in series
- V_{OC} = open circuit voltage of each module, when the ambient temperature is at its minimum value (refer to the product technical sheet)



WARNING

If additional PV modules must be installed in string with DualSun modules, their power and current must be equal to those of DualSun panels within the limits of manufacturers' tolerances

2. Wiring in parallel

For DualSun modules connected in parallel, a corresponding overcurrent protection must be used. To this end, a DC voltage fuse must be used to avoid reverse current. Refer to the maximum reverse current value in the product data sheet to determine the protection value. In addition, the operating conditions and design rules of the inverter manufacturer must be observed.

In case no string circuit breaker is used, the maximum number of authorized strings in parallel is limited to 2. For 3 strings in parallel or above, string circuit breakers correctly sized have to be used. In this case, the maximum number of strings in parallel is limited by the combiner box or inverter electrical characteristics and the system designer has to check these components technical datasheet to correctly define the number of strings in parallel.



CAUTION

Refer to the instructions of the inverter used



WARNING

For modules connected in parallel, only modules with the same nominal voltages will be used

The electrical installation must be carried out by qualified personnel and in accordance with current safety standards and IEC / EN 61730.

Refer to the grid operator requirements when installing the system.

The installation must be equipped with a circuit breaker to isolate at the same time all the cables that are not grounded by a minimum spacing of 3 mm at the contact level.

4.2. Position of the micro inverter for the FLASH 425 and the SPRING 425

When fixing the micro inverters on the roof structure, it is important to take care to anticipate the length of the cables.

This requires placing the micro inverter close to the edge of the panel (~5cm maximum). Thus when connecting the panel, when it is on the edge, the distance between the micro-inverter and the box will be minimal and the cables will be slack.

The side depends on the assembly direction of the panels. If you start with the leftmost panel on the line, you have to put the panels on the left edge, so align the micro inverters with the left side of the panel. To be reversed if the panels are added from right to left.

4.3. Electrical fittings, cables and diodes

The DualSun solar modules are supplied with cables, connectors, and a pre-equipped junction box. Before installation, check that the plugs and connections are not damaged.

Connect the positive plug of a module to the negative plug of the next module; see identification of the polarity of the EVO2 (manufacturer : Stäubli) connectors below:



To connect the modules, special solar cables with a minimum diameter of 4 mm² should be used. Only identical connectors (same brand and model) should be used. We therefore recommend the use of Stäubli Electrical type EVO2 connectors which are those present on the panels. These cables must be UV and wear resistant. Avoid leaving cables exposed to the elements or place them in a protective sheath.

Respect a minimum bending radius of 40 mm.

When connecting the connectors, it is important to ensure that they are connected in a watertight manner (minimum IP67).

When handling these cables, make sure that the tools used are dry.

All modules are supplied with pre-installed bypass diodes to minimize hot spots and module current losses in the event of (partial) shading.



CAUTION

Never connect or disconnect a live circuit



CAUTION

Never open the junction box

The junction box of the DualSun module contains bypass diodes which are in parallel connection with the cell wires. If a hot spot occurs locally on one or more cells, the diode will enter into service to prevent the main

current from flowing through the hot cells in order to limit overheating and loss of performance of the module. However, the bypass diode is not the overcurrent protection device.

If the LED appears to be out of order, the installer or system service agent should contact DualSun.

The maximum rating of a fuse connected in series with a cell chain is generally 15A, but the specific rating of the module can be found on the product label and in the product data sheet.

The diodes which are used as blocking diodes must have:

- Maximum average value tolerable by the junction [IF (AV)] above the maximum system current at the highest operating temperature of the module.
- Maximum repetitive peak value tolerable by the junction [VRRM] above the maximum system voltage at the lowest module operating temperature.

4.4. Bonding and lightning protection



CAUTION

The evaluation and design of the bonding and lightning protection system of PV installations must be carried out by trained and qualified personnel. It is imperative to refer to the local regulations in force to comply with specific requirements

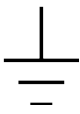

DualSun modules must be bonded with prongs, lugs or other suitable means.

Bonding can be done through the holes made for this purpose as part of each module. These holes allow the earth cable to be attached and connected to the equipotential bonding.

The frame of the panels is delivered with two earthing holes at each corner of the frame.



NOTE

Make sure that the Bonding is carried out with the appropriate connections (**stainless steel**), to avoid anodizing or oxidation of the module frame at the hole provided for bonding. The bonding device must be in good contact with the aluminum frame of the module.

Avoid direct contact between aluminum and copper by using an intermediate metal such as stainless steel or tin.

4.5. Indirect lightning strike

The installation must also be protected from indirect lightning strikes. Indeed, the drivers of the system can become inductive if a lightning strike erupts in the vicinity of the installation. To prevent this phenomenon, the

electrical cable loops must be avoided and the surface between the cables must be as small as possible, as can be seen in the graph below:

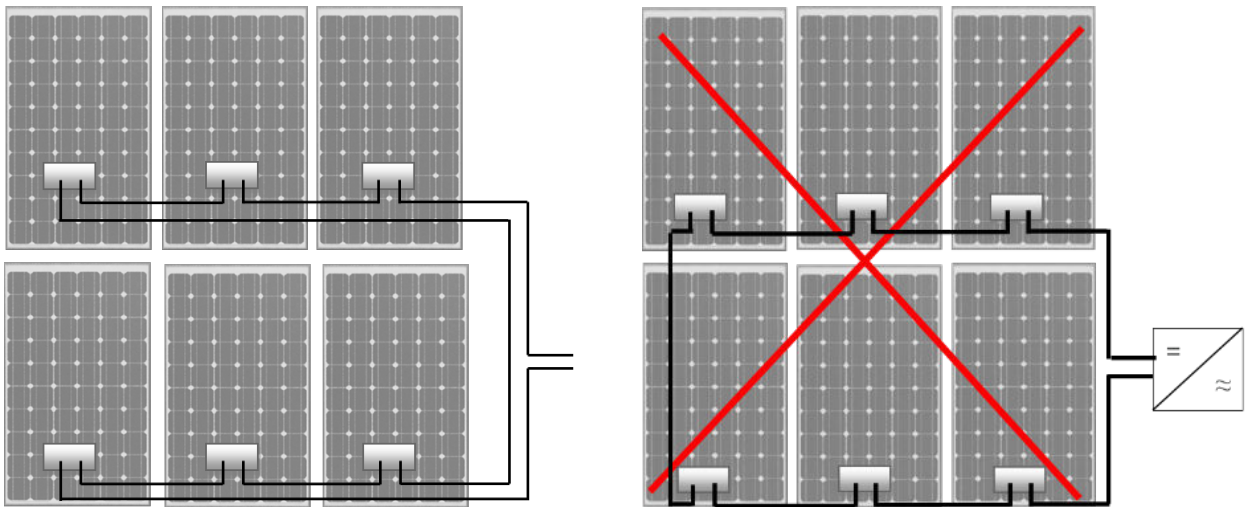

5. Cleaning the surface of the modules

The greater the degree of contamination of the surface of the PV system, the less the cells are able to absorb the energy contained in the incident sunlight.

By tilting the panels slightly in relation to the horizontal, rain and snow can clean the surface, and thus temporarily protect them from additional contamination. However, after a while, dust, leaves or bird droppings will dirty the glass on the front panel and thereby reduce the output power.

In case of persistent soiling, the panels should be washed with cold water and a soft sponge.

To clean greasy stains such as fingerprints (especially just after installation) you can use isopropyl alcohol.



CAUTION

Never use solvents or a pressure washer, and never scrape the panel surface. Cleaning operations must be carried out by qualified professionals.



DANGER

Work at height: Refer to the recommendation published by the national risk prevention body.

6. Decommissioning of the installation

Before any intervention on the device / installation, cut off the power supply and injection (via the appropriate fuse or a general switch, for example) and prevent any recommissioning.

For any intervention involving dismantling of the controllers, make sure that the internal components are not likely to cause a discharge of static electricity.

[Removing a module \[31\]](#)

[Decommissioning of the installation \[31\]](#)

6.1. Removing a module

If it is necessary to dismantle a module, the following procedure must be followed:

- Cut the electrical circuit upstream and downstream of the inverter.
- Risk of electric shock. For this, refer to the manufacturer's manual for the inverter / microinverter. For this it may be necessary to use a particular disconnection tool. Separate the module from its support.
- Disconnect the electrical connectors.
- Disconnect the module grounding.

6.2. Waste treatment

When handling waste from a used DualSun system, the applicable regional and national regulations must be observed.

DualSun is a PV Cycle member.

7. Responsibilities

DualSun	Installer	User
DualSun products are produced in compliance with the requirements of the various applicable European directives.	<p>The installation and the first commissioning must be carried out in the rules of the art in accordance with:</p> <ul style="list-style-type: none"> • The information in the installation instructions, • Legislation and standards in force. <p>The installer must inform the user of the need for regular maintenance.</p>	<p>The user must call on qualified professionals:</p> <ul style="list-style-type: none"> • To carry out the installation and carry out the initial commissioning, • To have regular maintenance performed on the installation. <p>The user must keep the installation documents near the system components.</p>

7.1. Guarantee conditions

See the document “[DualSun Contractual Guarantee](#)” for DualSun products.

For the other components of the installation, see the warranty conditions of the various manufacturers.

7.2. Disclaimer

DualSun cannot be held liable in the following cases:

- Failure to comply with the instructions contained in the Notice concerning the installation, use, operation and maintenance of the installation.
- Non-compliance with the safety rules defined in the recommendation published by the national risk prevention organization