

The smart system for solar roofs

The photovoltaic in-roof system Solrif

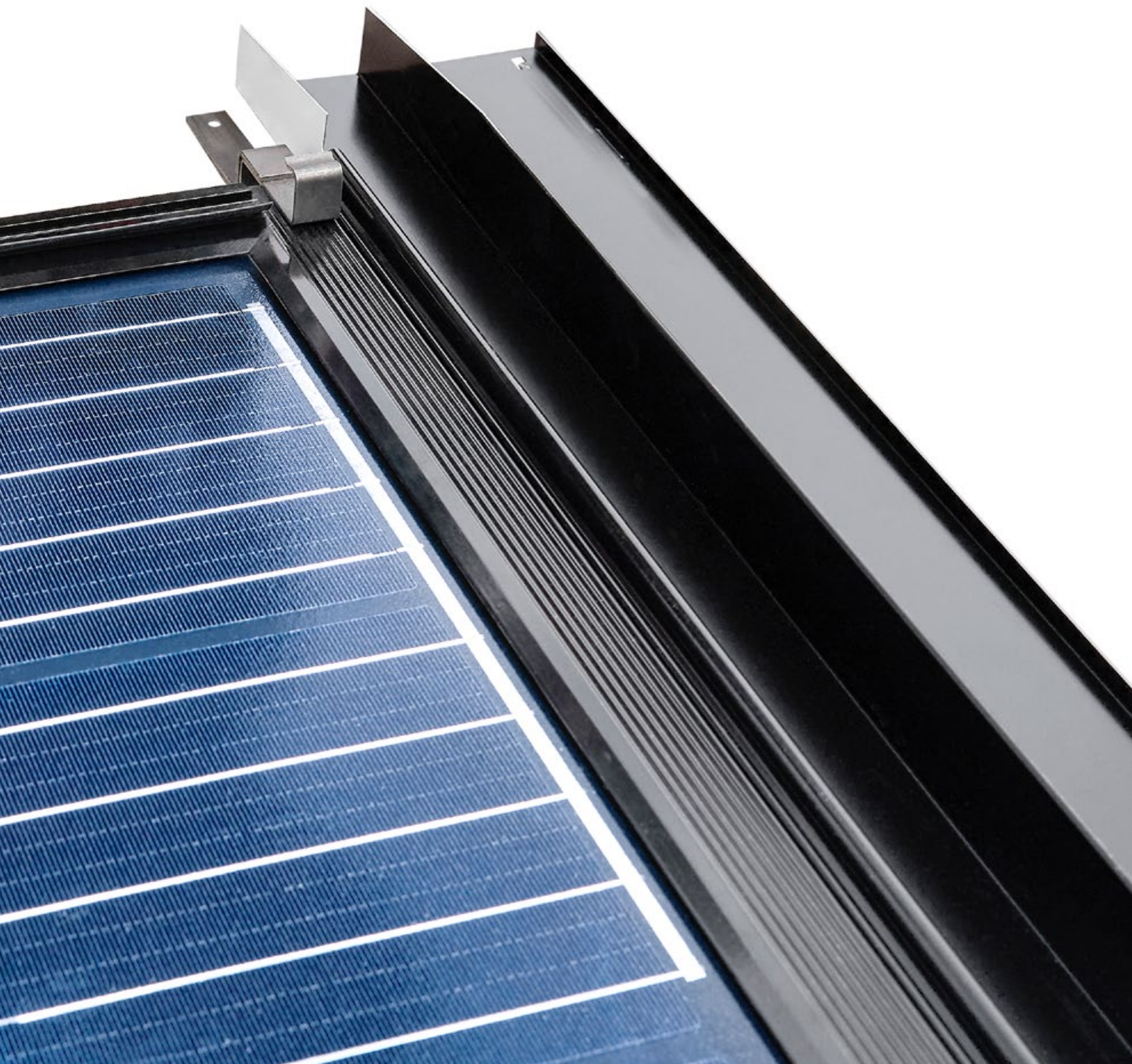

Solrif modules are a sustainable alternative to roof tiles

Solrif, the patented photovoltaic (PV) in-roof system from Schweizer, transforms a frameless standard module into a solar roof tile and thus replaces classic tile roofing on pitched roofs. Instead of tile battens, Solrif mounting battens measuring 120 × 30 mm are screwed into the substructure to hold the mounting clamps in place. Solrif creates the basis for PV solutions of high aesthetic quality for new buildings and renovation projects.

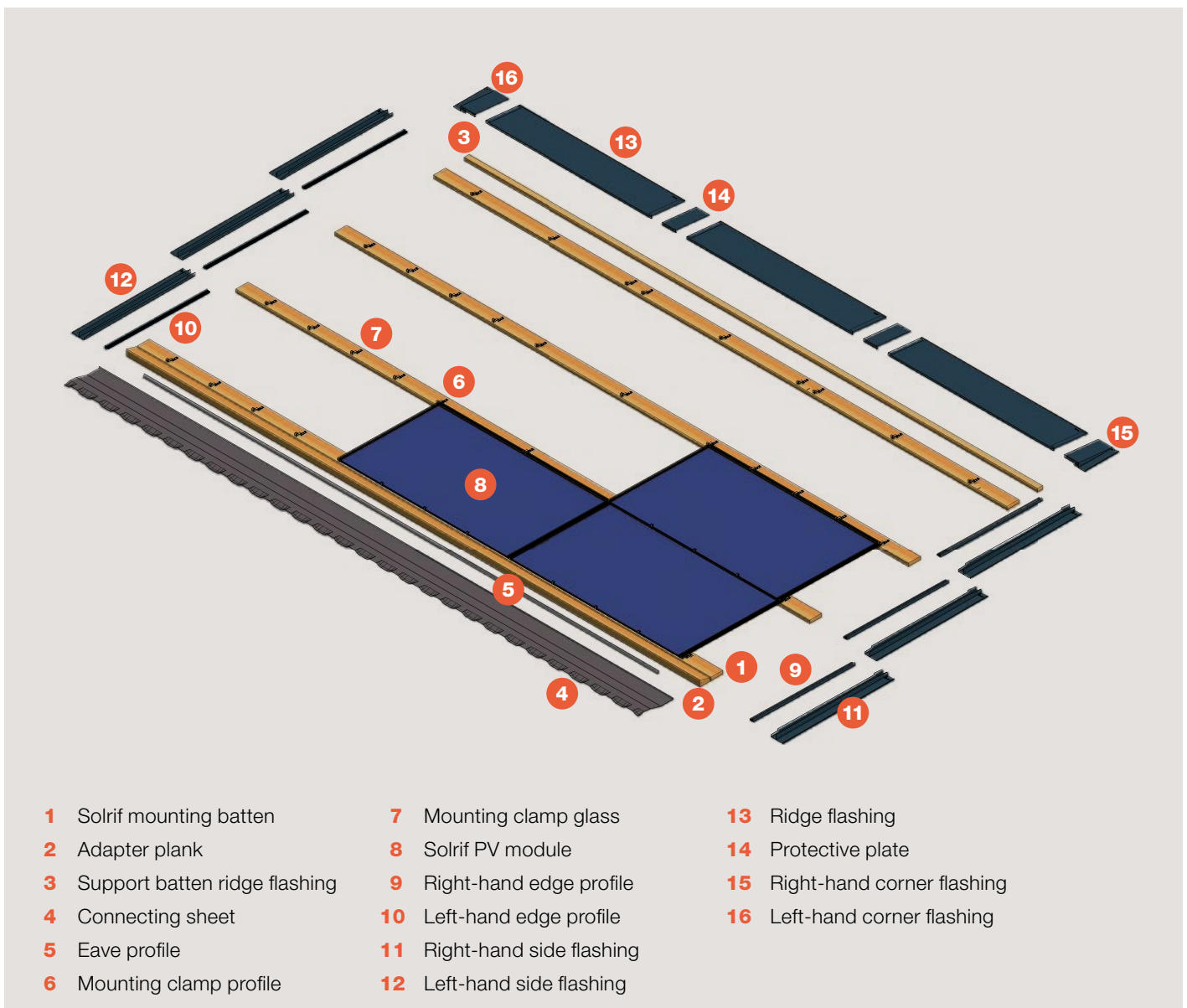

Solrif modules are the optimum alternative to tiles, either for new buildings or for roof renovations. They combine many practical advantages with aesthetic appeal. The roof substructure design is similar to that of a conventional tiled roof. The tiles required for the conventional roof can be dispensed with. In addition, there is a high degree of design freedom. The special design of the profiles also favours self-cleaning by rainwater and the slipping off of snow – the Solrif modules can thus always produce the maximum of electricity.



Easy installation

Solrif modules are held in place by mounting clamps fixed to the roof battens.

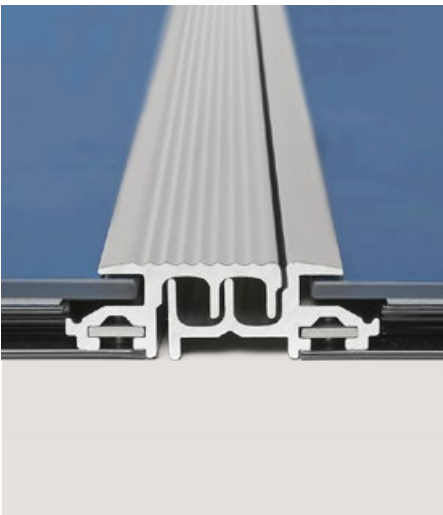

Optimum rain protection

Solrif frames of adjacent modules interlock on the left and right by means of a double fold and overlap from top to bottom – similar to roof tiles.

Solrif at a glance

Meeting the highest aesthetic standards

- Compelling design solutions, even for challenging projects and listed buildings

Reliable and high-quality

- Perfect rainproofing
- Straightforward service: modules individually replaceable
- Modules are floating, not clamped
- Laid cables are weatherproof
- Swiss quality

Environmentally friendly and efficient

- Forms a water-bearing layer and replaces the usual roof covering
- No maintenance required and good self-cleaning properties due to the open glass edge on the module underside
- No accumulation of dirt under the modules (birds' nests, martens, etc.)
- Good rear ventilation ensures high yield
- Short payback period for energy and ecological factors
- Lower CO₂ footprint compared to on-roof PV systems

Simple and quick installation

- For roof surfaces from 10° to 70° pitch
- Blind modules for obstacles or sloping roof ends
- Our own planning software: Solar.Pro.Tool
- Training, personal consultation and advice on mounting and installation on site

Planning made easy – with Solar.Pro.Tool

The web-based planning software supports the entire planning process – all project data can be entered directly and efficiently. Several simple building models are provided by the system for initial clarifications. Through the use of GIS data, even complex roofs can be quickly defined – and, if available, CAD plans can be uploaded. Partial roofs in combination with tile roofing or complete roofs are automatically optimised and designed. Static calculations and load limit checks are like-wise carried out automatically. An integrated tool for electrical design and yield simulation based on Polysun is also available.

Advantages of Solar.Pro.Tool

- User-friendly project planning with system design, structural assessment, electrics and possible alternatives
- Capture of building geometrics from Google, PDF, JPG or DXF
- Scalable to suit your requirements, unlimited number of planning projects and versions
- Planning with multiple module sizes possible
- Multiple roofs and houses in one design
- Cloud storage of the data enables convenient web-based access from any computer, even for entire teams
- Top-quality support from Schweizer specialists

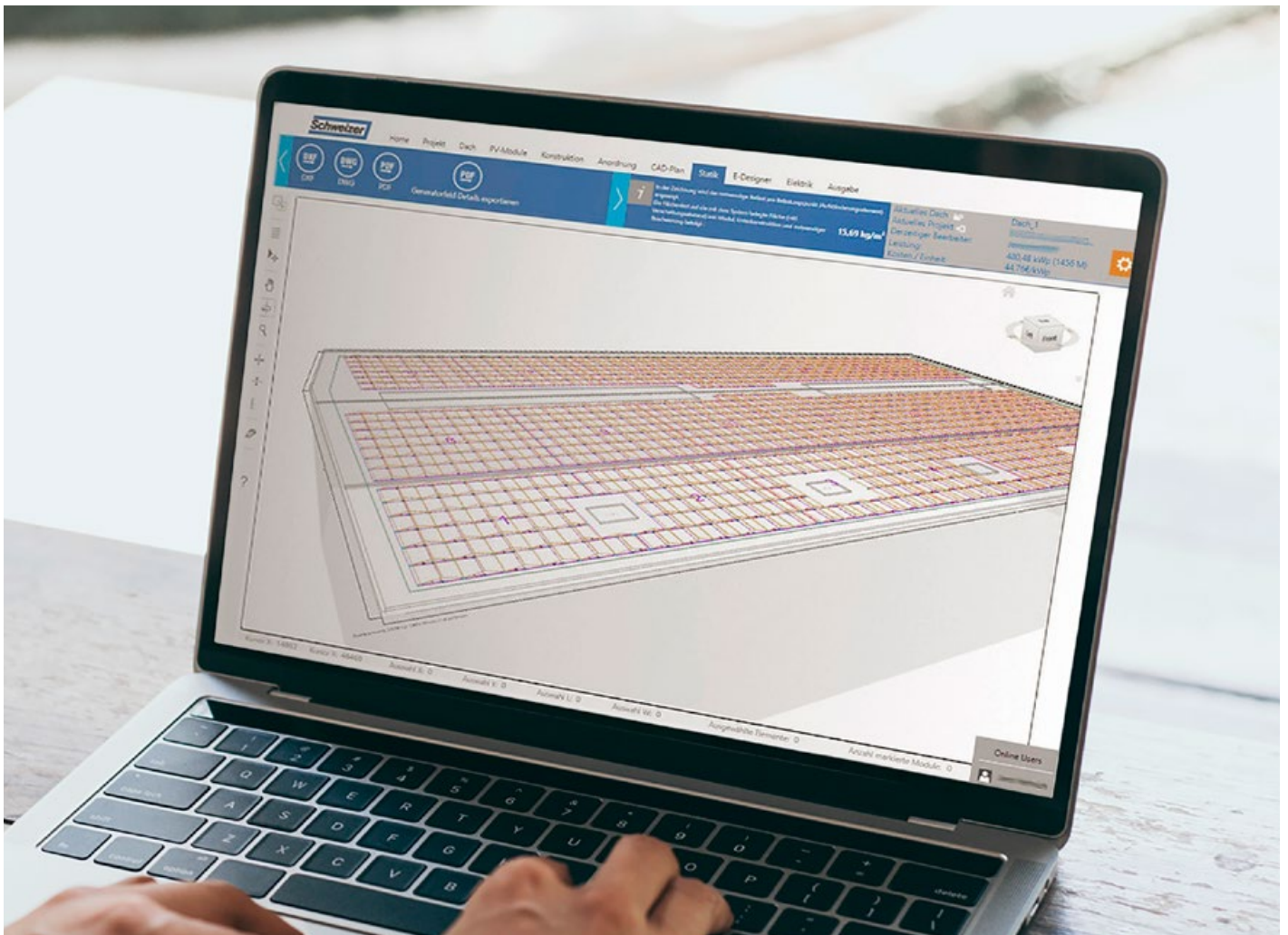

Precise sectional drawings enable building-specific implementation

For precise implementation, the grid sizes and installation dimensions (horizontal and vertical) and the exact field measurements are required. Sectional drawings from the Installation Guide supplement the information in the planning software.

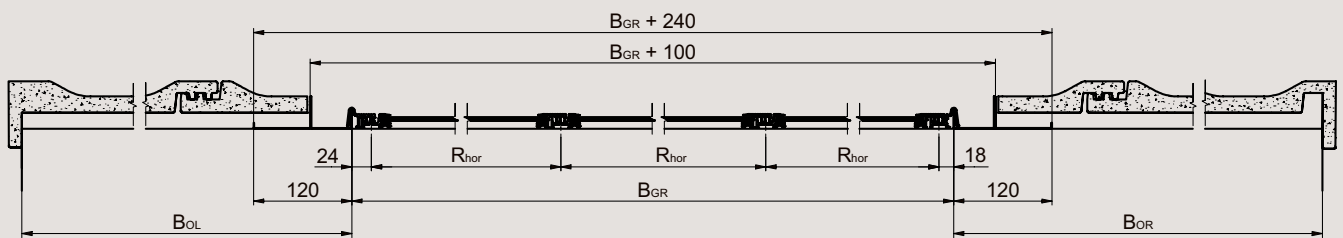

Horizontal section Solrif

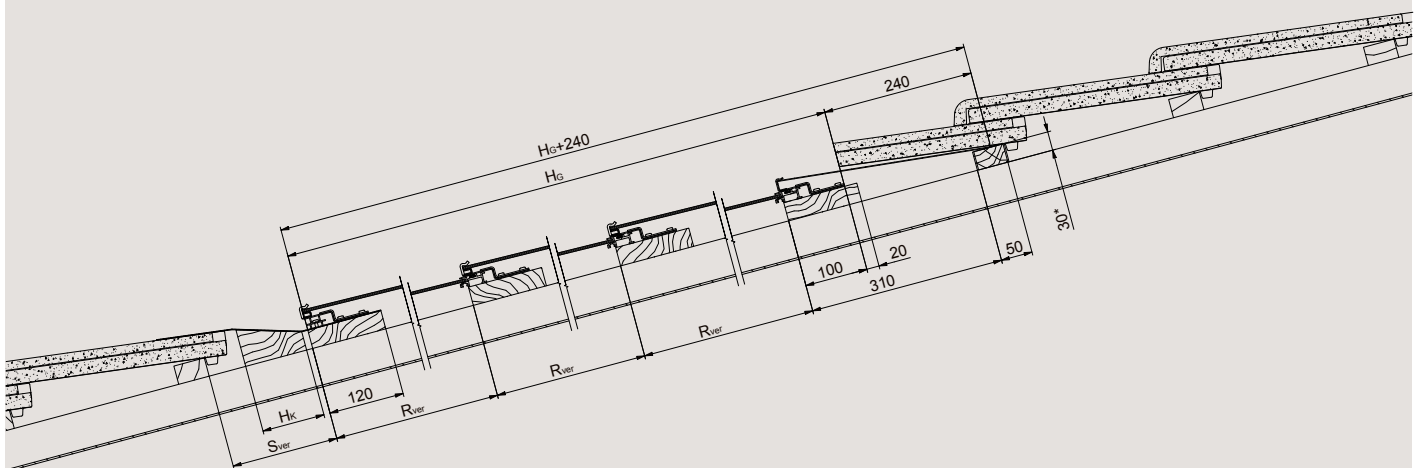

Vertical section Solrif

Request your personal licence now at:
en.solrif.com/planungssoftware



The in-roof system for all pitched roofs

The photovoltaic in-roof system Solrif can be used on all pitched roofs. It is mounted from bottom to top and from right to left. Thanks to the high degree of flexibility and modularity, projects can be implemented to meet any requirements. Solutions are available for complete roof coverings, partial areas and obstacles (skylights, chimneys, etc.).

Just a few working steps will give you a Solrif-solar roof:

1. Study planning report, parts list and site check list
2. Check delivery for completeness and conformity with the planning report
3. Measure the Solrif field (left, right, top and bottom) and consider possible obstacles
4. Check Solrif mounting batten distances; if necessary, mount additional battens or correct positioning according to plan
5. Mount lower transition element with adapter plank and eave apron or inlet plate in the rain gutter
6. Place eave profile on the edging apron
7. Mount the bottom row of clamps using the mounting gauge
8. Attach edge plates (if ordered) and edge profiles from the right, and lay modules including the electrical connections
9. Place further rows of clamps and insert modules
10. For a partial roof, cover the remaining area with tiles, for a full roof, place the sheet metal flashing at verge and ridge

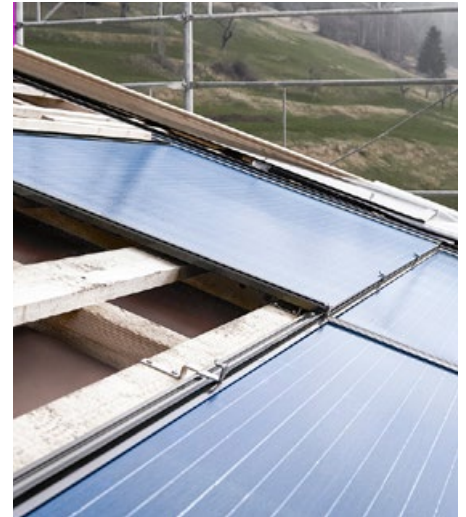

Solrif – tested and certified

Technical data

- Roof pitch: 10° to 70° (with foil subroof)
- Underlay and sarking membrane to prevent condensation and moisture in accordance with ZVDH/SIA 232/1
- Timber substructure: analogous to tiled roof or on vertical counter-battens

Certifications

Requirements	Standard	Certificate no.
TÜV design certificate	TÜV 2PfG1794	R 60100560
Design suitability and approval	EN 61215	TÜV 21226580.002
Corrosion resistance (ammonia)	IEC 62716	TÜV 21220296a_AC
Corrosion resistance (salt mist)	IEC 61701	TÜV 21220296a_SMC
Rain impact resistance	CEN/TR 15601	TU Berlin AZ 130208
Fire properties Kl. E	EN 13501-1	MPA Stuttgart 230009602-2
Fire resistance BROOF(t1)	EN 13501-5	MPA Stuttgart 902 5821 000-2
Design certification	CSTB GS no 21	Avis Technique 21/12-22
Patent	Europe	EP 1 060 520 B1

Our partners

The photovoltaic in-roof system Solrif is offered in combination with high-quality PV modules by the following module suppliers:



Aleo Solar GmbH
www.aleo-solar.de



AxSun Solar GmbH
www.axsun.de



BISOL Proizvodnja d.o.o.
www.bisol.com



CS-Wismar GmbH
www.sonnenstromfabrik.com



Soli tek cells, UAB
www.solitek.eu



Activ'Glass
www.activ-glass.com

Other solutions from Schweizer: MSP PV mounting system

The MSP modular PV on-roof system is the ideal solution for every roof – from flat to pitched to trapezoidal sheet metal roofs. In terms of technology and structural stability, it is leading-edge and quick and easy to mount. Once installed, the quality of materials and durability of the system are outstanding.

