

Solar Inverter

DRM0-INTERFACE

Quick Installation Guide

In addition to what is explained in this quick installation guide, the safety and installation information provided in the product manual must be read and followed. The technical documentation for the product is available at the website.
The device must be used in the manner described in the manual. If this is not the case the safety devices guaranteed by the inverter might be ineffective.

1. Preliminary operations

⚠ ATTENTION – REFER SERVICING TO QUALIFIED SERVICE PERSONNEL.

For safety reasons, only a qualified electrician who has received training and/or demonstrated skills and knowledge of the inverter's structure and operation may install this device in the inverter.

⚠ ATTENTION – Before the DRM0-INTERFACE has been installed on the inverter, the REMOTE ON/OFF function of the inverter have to be enabled to allow at the DRM0-INTERFACE to power-off the inverter when it is needed: Refer to the Product Manual of the related inverter to know how to enable the REMOTE ON/OFF function.



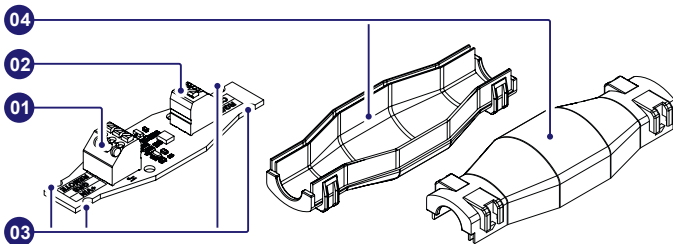

2. Main components

The main components of the DRM0-INTERFACE are shown in the figure and described in the following table:

Main components	
01	Inverter side connector
02	DRM0 side connector
03	Fixing eyelet
04	Enclosure

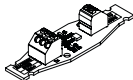
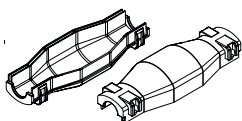
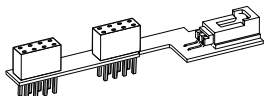

3. List of components supplied

Available components*	Quantity
	DRM0-INTERFACE board 1
	Plastic enclosure 1
	Adapter board 1
	Standoff 1
	Standoff screw 1
	DRM available label 1
	Cable tie 2

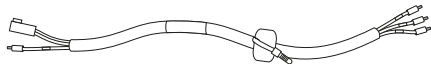

Cable Model 1
Single wire + adapter board connector

1

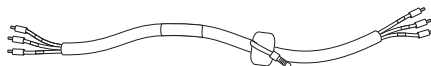

Cable Model 2
3-wires Cable

1

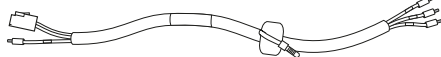

Cable Model 3
Single wire + RJ45 connector

1

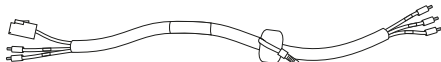

Cable Model 4
2-wires + Connector

1



Technical documentation

1

*The content of the packaging may depend on the DRM0-INTERFACE kit related to the single inverter model.

4. Lifting and transporting

- ⚠ WARNING –** To avoid risks of electrical shock, all wiring operations on the inverter must be carried out:
- with the DC disconnect switch internal (if present) and external (if present, applying LOTO procedures on it) to OFF position.
 - with the AC disconnect switch internal (if present) and external AC disconnect switch (applying LOTO procedures on it) to OFF position.
 - without any voltage supplied on the signal terminals (if present disconnect the voltage and applying LOTO procedures on it).

• **DRM0 side connection:**

To connect the DRM0-INTERFACE to the distribution grid use the DRM0 side connector **(02)** located in the DRM0-INTERFACE board marked by "J2" silkscreen.

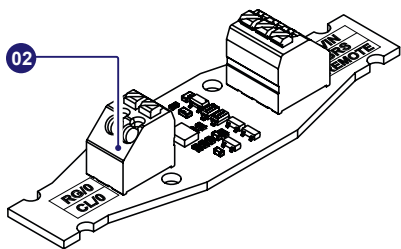

• **Inverter side connection:**

To connect the DRM0-INTERFACE to the inverter use the Inverter side connector **(01)** located in the DRM0-INTERFACE board marked by "J1" silkscreen. Each cable type have three wires marked with the same name of terminal of the Inverter side connector **(01)** (marked in the board silkscreen).

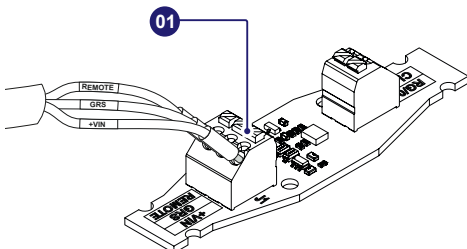

PVI-3.0/3.6/4.2-TL-OUTD (Construction A)

Cable to be used: Model 1
 Adapter board: Yes

DRM0-INTERFACE	Inverter terminals
REMOTE	+R (J42)
two poles connector	two poles connector on adapter board

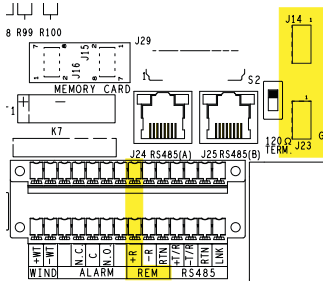

PVI-3.0/3.6/4.2-TL-OUTD (Construction B)

Cable to be used: Model 1
 Adapter board: Yes

DRM0-INTERFACE	Inverter terminals
REMOTE	+R (J9)
two poles connector	two poles connector on adapter board or on J4 METER connector (only if J4 connector is not already used by METER)

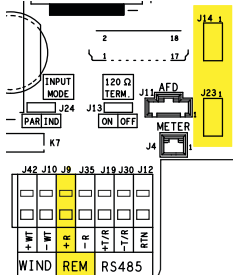

PVI-5000/6000-TL-OUTD (Construction A)

Cable to be used: Model 1
 Adapter board: Yes

DRM0-INTERFACE	Inverter terminals
REMOTE	+R (J49)
two poles connector	two poles connector on adapter board



PVI-5000/6000-TL-OUTD (Construction B)

Cable to be used: Model 1
 Adapter board: Yes

DRM0-INTERFACE	Inverter terminals
REMOTE	+R (J31)
two poles connector	two poles connector on adapter board or on J19 METER connector (only if J19 connector is not already used by METER)

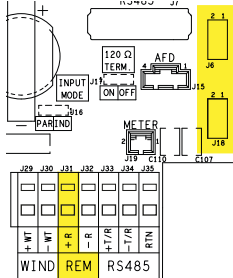

PVI-10.0/12.5-TL-OUTD (Construction A)

Cable to be used: Model 1
 Adapter board: Yes

DRM0-INTERFACE	Inverter terminals
REMOTE	+R (J47)
two poles connector	two poles connector on adapter board

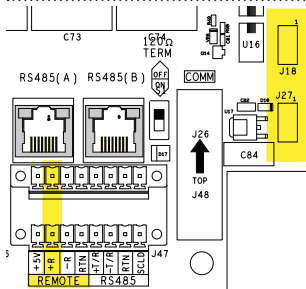

PVI-10.0/12.5-TL-OUTD (Construction B)

Cable to be used: Model 1
Adapter board: Yes

DRM0-INTERFACE	Inverter terminals
REMOTE	+R (J47)
two poles connector	two poles connector on adapter board

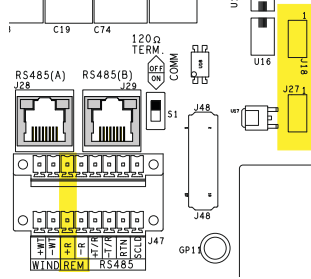

UNO-2.0/3.0-TL-OUTD

Cable to be used: Model 1
Adapter board: No

DRM0-INTERFACE	Inverter terminals
REMOTE	+R (J2)
two poles connector	(J17) "+12V" two poles connector

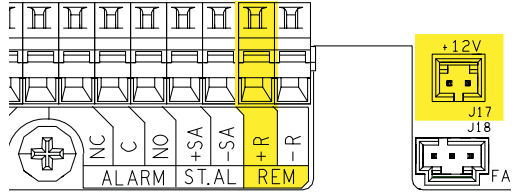

UNO-3.6/4.2-TL-OUTD

Cable to be used: Model 1
Adapter board: No

DRM0-INTERFACE	Inverter terminals
REMOTE	+R (J13)
two poles connector	(J27) two poles connector

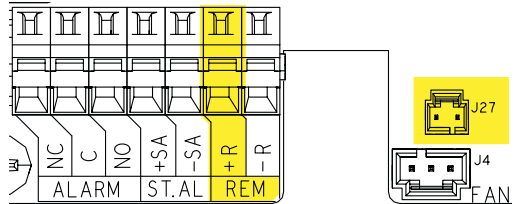

TRIO-5.0/5.8/7.5/8.5-TL-OUTD

Cable to be used: Model 3
Adapter board: No

DRM0-INTERFACE	Inverter terminals
REMOTE	R1 ON/OFF (J4)
two poles connector	J7 (RJ45 Connector)

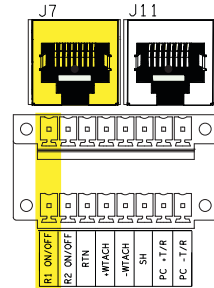

TRIO-20.0/27.6-TL-OUTD

Cable to be used: Model 2
Adapter board: No

DRM0-INTERFACE	Inverter terminals
REMOTE	R ON/OFF (J4)
+VIN	+5VOUT (J4)
GRS	GND COM (J4)

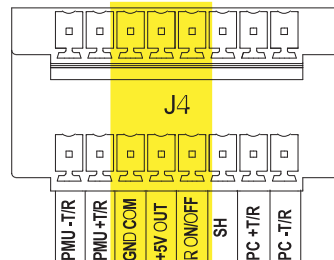

TRIO-50.0/60.0 TL/TM

Cable to be used: Model 2
Adapter board: No

DRM0-INTERFACE	Inverter terminals
REMOTE	R1 ON/OFF (J7)
+VIN	+5V (J7)
GRS	RTN (J7)

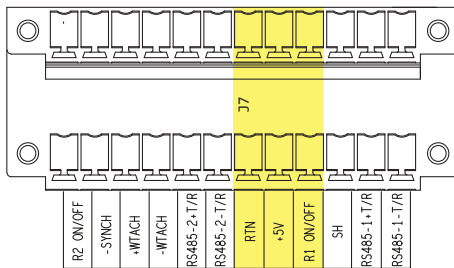

REACT-UNO-3.6/4.6-TL-OUTD

Cable to be used: Model 2
Adapter board: No

DRM0-INTERFACE	Inverter terminals
REMOTE	4 (J3)
+VIN	6 (J3)
GRS	12 (J3)

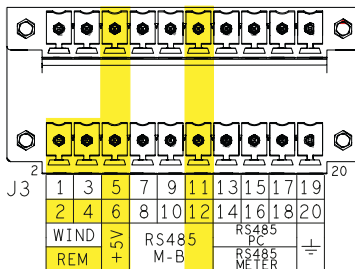

REACT2-UNO-3.6/5.0-TL

Cable to be used: Model 2
Adapter board: No

DRM0-INTERFACE	Inverter terminals
REMOTE	2 (J31)
+VIN	6 (J31)
GRS	4 (J31)

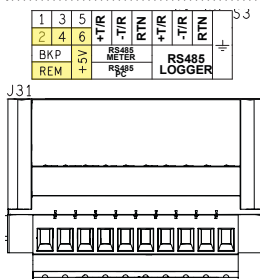

PVS-100/120-TL

Cable to be used: Model 4
Adapter board: No

DRM0-INTERFACE	Inverter terminals
REMOTE	1 (J1 - REMOTE ON/OFF)
+VIN	J38 (two poles connector)
GRS	2 (J1 - REMOTE ON/OFF)

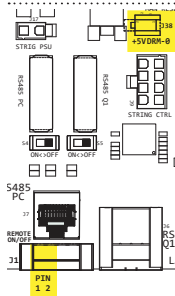

PVS-50/60-TL

Cable to be used: Model 2
Adapter board: No

DRM0-INTERFACE	Inverter terminals
REMOTE	R1 ON/OFF (J7)
+VIN	+5V (J7)
GRS	RTN (J7)

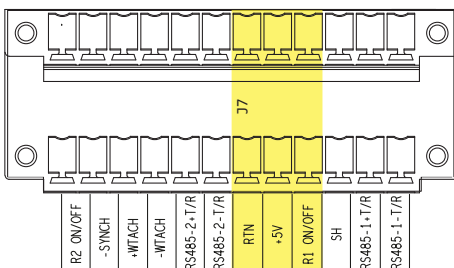

5. Installation of the adapter board

For the models that require the installation of the adapter board (refer to the previous table), see picture (A).

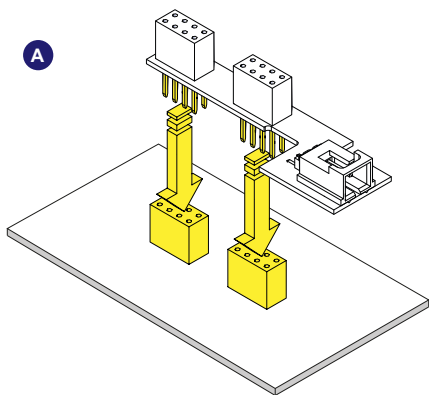

Note for installation on inverter equipped with WIFI LOGGER CARD (VSN300):

In this case it is necessary to install the standoff (supplied with the packaging) under the mechanical mounting bracket as shown in the picture (B).

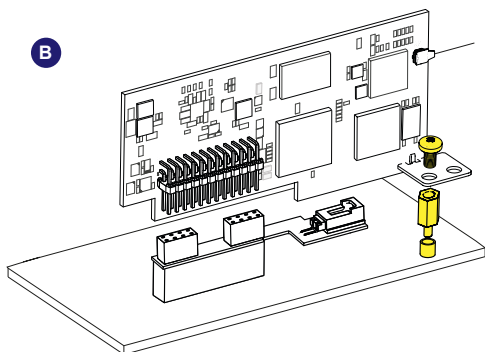

After the installation of the adapter board to the inverter it will be possible to connect the DRM0-INTERFACE to the adapter board using the specific connector of cable "Model 1" as shown in the picture (C).

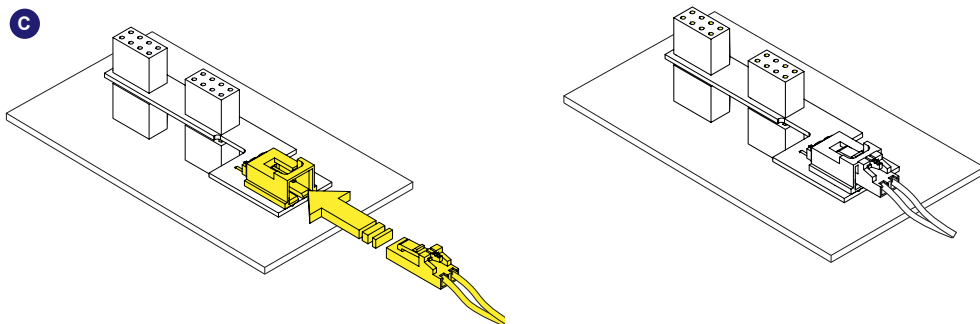

6. Final assembly and check

After the installation on the inverter board it will be possible to fix the wires on DRM0-INTERFACE board using the fixing eyelet (03) with the supplied cable tie on both sides.

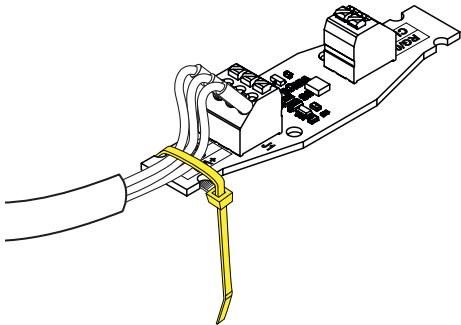

After the cable fixing, close the enclosure (04) to complete the DRM0-INTERFACE assembly.

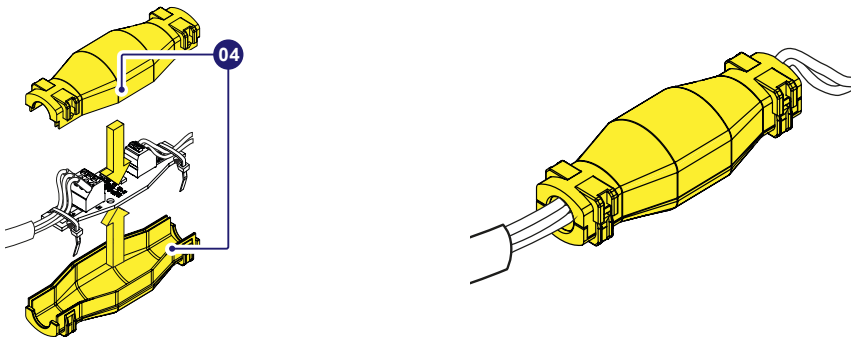

After the assembly, make sure to put the DRM0-INTERFACE inside the inverter enclosure in a suitable position: The DRM0-INTERFACE device position cannot interfere with mobile parts of the inverter (fans, switch...) or dangerous electrical parts.

To check if the DRM0-INTERFACE works, switch on the inverter and disconnect the wire from DRED: in case of a correct installation the inverter should power-off.

At the end of installation phase, apply the supplied "DRM available label" near the Regulatory label of the inverter. The DRM available label shows which type of DRM is available for the inverter.

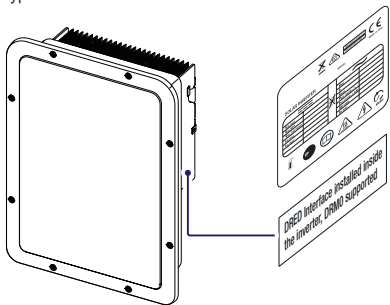

For more information please contact your local FIMER representative or visit:

fimer.com

We reserve the right to make technical changes or modify the contents of this document without prior notice. With regard to purchase orders, the agreed particulars shall prevail. FIMER does not accept any responsibility whatsoever for potential errors or possible lack of information in this document.

We reserve all rights in this document and in the subject matter and illustrations contained therein. Any reproduction, disclosure to third parties or utilization of its contents – in whole or in parts – is forbidden without prior written consent of FIMER. Copyright© 2021 FIMER. All rights reserved.