



SolarEdge Home Hub Inverter - Three Phase

For Europe and APAC

Version 1.1

Disclaimers

Important Notice

Copyright © SolarEdge Inc. All rights reserved.

No part of this document may be reproduced, stored in a retrieval system or transmitted, in any form or by any means, electronic, mechanical, photographic, magnetic or otherwise, without the prior written permission of SolarEdge Inc.

The material furnished in this document is believed to be accurate and reliable. However, SolarEdge assumes no responsibility for the use of this material. SolarEdge reserves the right to make changes to the material at any time and without notice. You may refer to the SolarEdge web site (www.solaredge.com) for the most updated version.

All company and brand products and service names are trademarks or registered trademarks of their respective holders.

Patent marking notice: see <http://www.solaredge.com/patent>

The general terms and conditions of delivery of SolarEdge shall apply.

The content of these documents is continually reviewed and amended, where necessary. However, discrepancies cannot be excluded. No guarantee is made for the completeness of these documents.

The images contained in this document are for illustrative purposes only and may vary depending on product models.

This manual describes installation of the SolarEdge Home Hub Inverters - Three Phase. Read this manual before you attempt to install the product, and follow the instructions throughout the installation process. If you are uncertain about any of the requirements, recommendations, or safety procedures described in this manual, contact SolarEdge Support immediately for advice and clarification. The information included in this manual is accurate at the time of publication. However, the product specifications are subject to change without prior notice. In addition, the illustrations in this manual are meant to help explain system configuration concepts and installation instructions. The illustrated items may differ from the actual items at the installation location.

Contents

Disclaimers	1
Important Notice	1
Revision History	4
HANDLING AND SAFETY INSTRUCTIONS	5
Safety Symbols Information	5
IMPORTANT SAFETY INSTRUCTIONS	5
Chapter 1: Overview	9
The SolarEdge Home Hub Solution Components	9
Installation Equipment List	10
Inverter Transport and Storage	11
Chapter 2: Installing the Power Optimizers	13
Safety	13
Installation Guidelines	15
Step 1: Mounting the Power Optimizers	18
Step 2: Connecting a PV module to a Power Optimizer	19
Step 3: Connecting Power Optimizers in Strings	20
Step 4: Verifying Proper Power Optimizer Connection	21
Chapter 3: Installing the Inverter	22
Inverter Package Contents	22
Identifying the Inverter	22
Unpacking the inverter	22
Inverter Interfaces	23
Mounting the Inverter	24
Selecting a Residual Current Device (RCD)	26
Chapter 4: Installing the Battery	27
Chapter 4: Installing the BUI	28
Chapter 5: Connecting the Inverter	29
Opening the Inverter Cover	29
Connecting PV Strings to the Inverter	30
Connecting the Battery	31
Closing the Inverter Cover	35
Chapter 6: Activating, Commissioning and Configuring the System	37
Step 3: Verifying Proper Activation and Commissioning	40
Chapter 7: Setting Up Communication with the Monitoring Platform	41
Communication Options	41
Creating an Ethernet (LAN) Connection	43
Creating RS485 Bus Connection	46

RS485 Bus Configuration	48
Verifying the Connection	49
Reporting and Monitoring Installation Data	50
Appendix A: Errors and Troubleshooting	53
Identifying Errors	53
Troubleshooting Communication	54
SolarEdge Home Hub Inverter - Three Phase Troubleshooting	55
Power Optimizer Troubleshooting	56
Appendix B: Mechanical Specifications	58
Appendix C: SafeDC™	59
Support Contact Information	60

Revision History

Version 1.1 (April 2023)

 Various updates

Version 1.0 (August 2022)

 Initial version

HANDLING AND SAFETY INSTRUCTIONS

Safety Symbols Information

The following safety symbols are used in this document. Familiarize yourself with the symbols and their meaning before installing or operating the system.

WARNING!



Denotes a hazard. It calls attention to a procedure that, if not correctly performed or adhered to, could result in **injury or loss of life**. Do not proceed beyond a warning note until the indicated conditions are fully understood and met.

CAUTION!



Denotes a hazard. It calls attention to a procedure that, if not correctly performed or adhered to, could result in **damage or destruction of the product**. Do not proceed beyond a caution sign until the indicated conditions are fully understood and met.



NOTE

Denotes additional information about the current subject.



IMPORTANT SAFETY FEATURE

Denotes information about safety issues.

Disposal requirements under the Waste Electrical and Electronic Equipment (WEEE) regulations:



NOTE

Discard this product according to local regulations or send it back to SolarEdge.

IMPORTANT SAFETY INSTRUCTIONS

SAVE THESE INSTRUCTIONS

WARNING!



The inverter cover must be opened only after shutting off the inverter P/ON/OFF switch located at the bottom on the inverter. This disables the DC voltage inside the inverter. Wait five minutes before opening the cover. Otherwise, there is a risk of electric shock from energy stored in the capacitors.



P = Program/Pair
1 = ON
0 = OFF

Figure 1: P/ON/OFF switch

WARNING!

Before operating the inverter, ensure that the inverter AC power cable and wall outlet are grounded properly. This product must be connected to a grounded, metal, permanent wiring system, or an equipment-grounding conductor must be run with the circuit conductors and connected to the equipment grounding terminal or lead on the product.

WARNING!

Opening the inverter and repairing or testing under power must be performed only by qualified service personnel familiar with this inverter.

WARNING!

Do not touch the PV panels or any rail system connected when the inverter switch is ON, unless grounded.

WARNING!

SafeDC complies with IEC60947-3 when installing the system with a worst case SafeDC voltage (under fault conditions) < 120V.



The worst case voltage is defined as: $V_{oc,max} + (\text{String Length} - 1) * 1V$, where:

$V_{oc,max}$ = Maximum Voc (at lowest temperature) of the PV modules in the string (for a string with multiple modules, use the max value)

- String Length = number of power optimizers in the string

CAUTION!

This unit must be operated according to the technical specification datasheet provided with the unit.

CAUTION!

HEAVY OBJECT. To avoid muscle strain or back injury, use proper lifting techniques, and if required - a lifting aid.

NOTE

The inverter is IP65 rated . Unused conduit openings and glands should be sealed with appropriate seals.

NOTE

Use PV modules rated according to IEC 61730 class A.

NOTE

The symbol  appears at grounding points on the SolarEdge equipment. This symbol is also used in this manual.

NOTE

SolarEdge inverters can be installed in sites with an alternative power source such as a generator. SolarEdge requires installing a physical or electronic interlock, which will signal to the inverter when the grid has been disconnected. Interlock procurement, installation, maintenance and support are the responsibility of the installer. Damage to the inverter due to incorrect interlock installation or use of an interlock that is incompatible with the SolarEdge system will render the SolarEdge warranty invalid.

For more information on connecting an alternative power source to SolarEdge inverter, refer to

<https://www.solaredge.com/sites/default/files/se-inverter-support-of-voltage-sources.pdf>.

**NOTE**

The following warning symbols appear on the inverter warning label:



Risk of electric shock



Risk of electric shock from energy stored in the capacitor. Do not remove cover until 5 minutes after disconnecting all sources of supply.



Hot surface – To reduce the risk of burns, do not touch.



Caution, risk of danger

**WARNING!**

Before operating the system, make sure all components are properly grounded.

**WARNING!**

When handling the battery, adhere to all manufacturer safety instructions.

**CAUTION!**

This unit must be operated under the specified operating conditions as described in the technical specifications supplied with the unit.

**NOTE**

The battery used with the inverter must conform to all local certification requirements.



NOTE

For battery decommissioning and disposal, follow the manufacturer requirements and instructions.

Chapter 1: Overview

SolarEdge Home Hub™ solution for Smart Energy Management enables connecting a compatible and external Storage to the inverter as well as operation on grid outage (AKA "Backup operation"). Backup operation of the inverter requires installation of backup Interface (AKA "BUI"), to be purchased separately from SolarEdge.

Power is stored in the battery and can be used for various applications such as: backup operation during grid outage, maximized self-consumption, and time of user profile programming.

The SolarEdge Home Hub Solution Components

- **SolarEdge Home Hub Inverter - Three Phase** is connected to a battery and supplies control and monitoring signals to the battery for operation, in addition to its traditional functionality as a DC-optimized PV inverter.
- **Energy Meter** - The meter is used by the inverter for export/ consumption readings, and for Smart Energy Management applications, such as: export limitation, and maximizing self-consumption.
- **Energy Storage** - A 48V battery designed to work with the SolarEdge Home Hub system. Make sure to use SolarEdge-approved batteries only.
- **Backup Interface** - an external component that enables the Home Hub inverter to work under grid outage.
- **Smart devices**

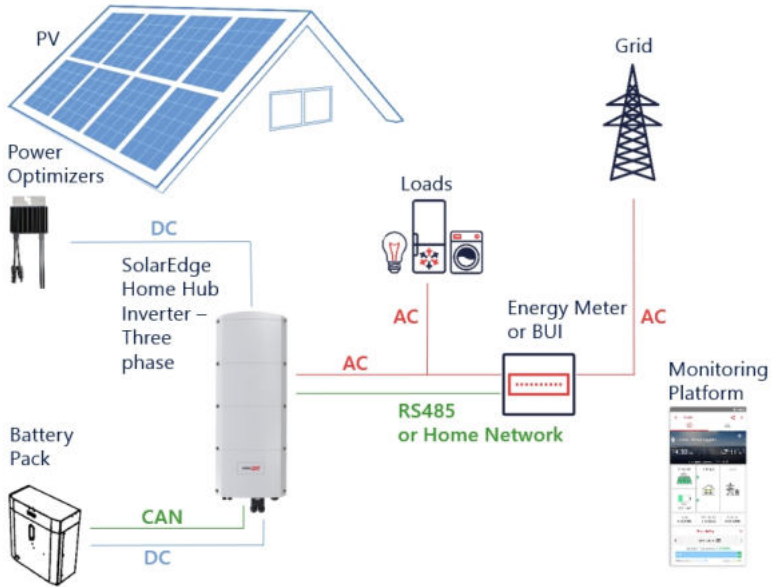

Figure 2: SolarEdge Home Hub system components

NOTE

- Additional SolarEdge inverters (with or without batteries) can be connected through RS485, or SolarEdge Wireless Network (needs specific adapter). The inverters will participate in export limitation and Smart Energy Management.
- PV modules connected to power optimizers are not mandatory for charge/ discharge profile programming.



Installation Equipment List

Standard tools can be used during the installation of the SolarEdge Home Hub system. The following is a recommendation of the equipment needed for installation:

- Allen screwdriver for 5mm screw type for the inverter cover and inverter side screws
- Allen screwdriver for M5/M6/M8 screw types
- Safety gloves
- Standard flat-head screwdrivers set
- Non-contact voltage detector

- Cordless drill (clutch) or screwdriver and bits suitable for the surface on which the inverter and optimizers will be installed. Use of an impact driver is *not* allowed
- Appropriate mounting hardware (for example: stainless bolts, nuts, and washers) for attaching:
 - the mounting bracket to the mounting surface
 - the power optimizer to the racking (not required for smart modules)
- Wire cutters
- Wire strippers
- Voltmeter

For installing the communication options, if not using Home Network, make sure you have the following:

- For Ethernet:
 - CAT5/6 twisted pair straight Ethernet cable with RJ45 connector
 - If using a CAT6 cable spool: RJ45 connector and RJ45 crimper
- For RS485:
 - Four- or six-wire shielded twisted pair cable.
 - Watchmaker precision screwdriver set
- For CAN
 - Six-wire shielded twisted pair cable with RJ45 connector
 - CAT5 twisted pair straight Ethernet cable with RJ45 connector

For connecting the battery's DC to the inverter, use copper cables with the following parameters:

- Maximum length: 5m
- Cross-section area: 35², double isolation 600V
- Crimping tools
- Shrinking tools
- Supplied shoe cable

Inverter Transport and Storage

Transport the inverter in its original packaging, facing up and without exposing it to unnecessary shocks. If the original package is no longer available, use a similar box that can withstand the weight of the inverter (refer to the inverter weight in the specification

datasheet provided with the unit), has a handle system and can be closed fully. Store the inverter in a dry place where ambient temperatures are -25°C to $+65^{\circ}\text{C}$ / -13°F to 149°F .

Chapter 2: Installing the Power Optimizers

Safety

The following notes and warnings apply when installing the Power Optimizers. Some of the following may not be applicable to smart modules:

WARNING!



When modifying an existing installation, turn OFF the inverter ON/OFF/P switch and the AC circuit breaker on the main AC distribution panel.

CAUTION!



Power Optimizers are IP68/NEMA6P rated. Choose a mounting location where Power Optimizers will not be submerged in water.

CAUTION!



The Power Optimizer must be operated according to the technical specifications provided with the Power Optimizer.

CAUTION!



Cutting the Power Optimizer input or output cable connector is prohibited and will void the warranty.

CAUTION!



All PV modules must be connected to a Power Optimizer.

CAUTION!



If you intend to mount the Power Optimizers directly to the module or module frame, first consult the module manufacturer for guidance regarding the mounting location and the impact, if any, on module warranty. Drilling holes in the module frame should be done according to the module manufacturer instructions.

CAUTION!

Installing a SolarEdge system without ensuring compatibility of the module connectors with the Power Optimizer connectors may be unsafe and could cause functionality problems such as ground faults, resulting in inverter shut down. To ensure mechanical and electrical compatibility of the Power Optimizer connectors with the PV module connectors to which they are connected:

- Use identical connectors from the same manufacturer and of the same type on the Power Optimizers, modules and the inverter DC input; or
- Verify that the connectors are compatible in the following way:
 - The module connector manufacturer should explicitly verify compatibility with the Power Optimizer connectors and the Inverter DC input connectors.
 - A third-party test report by one of the listed external labs (TUV, VDE, Bureau Veritas UL, CSA, InterTek) should be obtained, verifying the compatibility of the connectors.

For more information, refer to

<https://www.solaredge.com/sites/default/files/optimizer-input-connector-compatibility.pdf>

**IMPORTANT SAFETY FEATURE**

Modules with SolarEdge Power Optimizers are safe. They carry only a low safety voltage before the inverter is turned ON. As long as the power optimizers are not connected to the inverter or the inverter is turned OFF, each Power Optimizer will output a safe Voltage of 1V.

Installation Guidelines

- For the minimum and maximum number of Power Optimizers in a PV string (PV string length), see the Power Optimizer datasheets. Refer to the Designer for PV string length verification. The Designer is available on the SolarEdge website at: <https://www.solaredge.com/products/installer-tools/designer#/>.
- Do not use extension cables between a module and a Power Optimizer, between two modules connected to the same Power Optimizer, or between two Power Optimizers other than in the following cases:

Between a Power Optimizer and a module:

- Extension cables of up to 1.8 m are allowed for all Power Optimizers (0.9 m for DC+, and 0.9 m for DC -).
- SolarEdge Sense Connect technology monitors the S-Series Power Optimizer cable connectors and the direct connection created between them and another connector.
- P-Series Power Optimizers with the 4-type suffix in their part number (Pxxx-4xxxxxx) and the Mxxx-Series - extension cables of up to 16 m can be installed per Power Optimizer (8 m for DC+, and 8 m for DC-).

Between two PV modules connected in series to a Power Optimizer

When connecting two PV modules in series to supported Power Optimizers – an extension cable may be installed between the two modules, if the following conditions are met:

- The total round-trip cable length between the (+) and the (-) input terminals of the power optimizer (including the extension cable between the modules and the module output cables) does not exceed 16m/52.5ft.
- Supported Commercial Power Optimizers with the following part numbers are used:
 - Pxxx-4xxxxxx (P Series with 4-type in part number suffix)
 - Sxxx-1xxxxxx (S Series with 1-type in part number suffix)
- The connectors on each end of the extension cable must be identical to PV module's output connectors.



NOTE

The extension cable between two modules is considered as auxiliary equipment and is not covered by the SolarEdge warranty.

NOTE

When using a serial input optimizer for up to two modules connected in series, and PV modules installed in landscape orientation, it is recommended to use PV modules with long output cables to avoid the use of an extension (jumper cable) between two modules.



"Modules with long output cables" refers to modules with longer cables intended for landscape installation. The output cables length is usually specified in the Mechanical Characteristics section of the PV Module Datasheet.

For planning considerations when connecting multiple PV modules to an Power Optimizer, refer to:

<https://www.solaredge.com/sites/default/files/application-note-connecting-solaredge-power-optimizers-to-multiple-pv-modules.pdf>

Between two Power Optimizers or between a Power Optimizer and the inverter:

- Extension cables can be installed between Power Optimizers only from row to row, around obstacles or pathways within a row and from the end of the PV string to the inverter. The total length of the extension cables may not exceed the following values:

Single Phase Inverters	Three Phase Inverters
All - 300 m	SExxK-RWB - 200 m / 650 ft
	SE17K and below - 300 m / 1000 ft
	SE9KUS, SE20KUS - 300 m / 1000 ft
	SE17.5K and above - 700 m / 2300 ft

*The same rules apply for Synergy units of equivalent power ratings, that are part of the modular Synergy technology inverter.

- Frame-mounted Power Optimizers are mounted directly on the module frame, regardless of racking system (rail-less or with rails). For installation of frame-mounted Power Optimizers, refer to http://www.solaredge.com/sites/default/files/installing_frame_mounted_power_optimizers.pdf.
- The Power Optimizer can be placed in any orientation.
- Position the Power Optimizer close enough to its module so that their cables can be connected.

- Make sure to use Power Optimizers that have the required output and input conductor length.
- Completely shaded modules may cause their Power Optimizers to temporarily shut down. This will not affect the performance of the other Power Optimizers in the PV string, as long as the minimum number of unshaded Power Optimizers connected in a PV string of modules is met. If under typical conditions fewer than the minimum Power Optimizers are connected to unshaded modules, add more Power Optimizers to the PV string.
- To allow for heat dissipation, maintain the following clearance:
For All Power Optimizers, except for the M1600

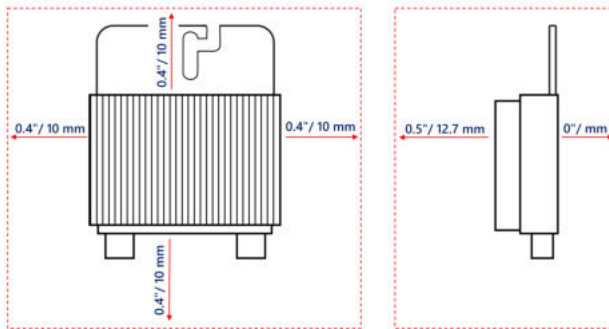

Figure 3: Clearance for heat dissipation around the Power Optimizer

- When installing PV modules in a confined space such as Building-integrated photovoltaic (BIPV) modules, ventilation measures may be required to ensure that the Power Optimizers are not exceeding the maximum temperatures stated in their specifications.

Step 1: Mounting the Power Optimizers

For each of the Power Optimizers⁽¹⁾:

1. Determine the Power Optimizer mounting location and use the Power Optimizer mounting brackets to attach the Power Optimizer to the support structure. It is recommended to mount the Power Optimizer in a location protected from direct sunlight. For frame-mounted Power Optimizers follow the instructions supplied with the optimizers, or refer to https://www.solaredge.com/sites/default/files/installing_frame_mounted_power_optimizers.pdf.



2. If required, mark the mounting hole locations and drill holes.

CAUTION!



Drilling vibrations may damage the Power Optimizer and will void the warranty. Use a torque wrench or an electric drill with adjustable clutch that meets the mounting torque requirements. *Do not* use impact drivers for mounting the Power Optimizer.

Do not drill through the Power Optimizer or through the mounting holes.

3. Attach each Power Optimizer to the rack using M6 or M8 stainless steel bolts, nuts and washers or other mounting hardware. Apply torque of 9-10 N*m.
4. Verify that each Power Optimizer is securely attached to the module support structure.
5. Record Power Optimizer serial numbers and locations, as described in *Reporting and Monitoring Installation Data* on page 50.

⁽¹⁾Not applicable to smart modules.

Step 2: Connecting a PV module to a Power Optimizer

NOTE



Improper wiring may cause electrical faults in a PV system. To avoid electrical faults, verify proper locking of connectors and avoid cable tension and friction. Proper planning, materials and installation reduce the risk of electric arcs, short-circuits and ground faults in the PV system.

NOTE



Images are for illustration purposes only. Refer to the label on the product to identify the plus and minus input and output connectors.

For each of the Power Optimizers:

- Connect the Plus (+) output connector of the module to the Plus (+) input connector of the Power Optimizer.
- Connect the Minus (-) output connector of the module to the Minus (-) input connector of the Power Optimizer.

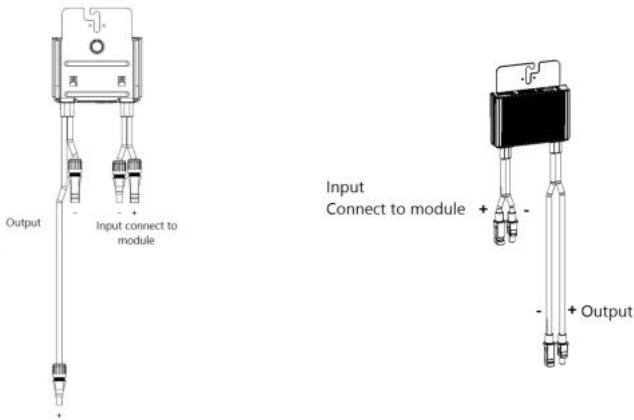

Figure 4: S-Series (left) and P-Series (right) Power Optimizer connectors

Step 3: Connecting Power Optimizers in Strings

You can construct parallel strings of unequal length, that is, the number of power optimizers in each string does not have to be the same. The minimum and maximum string lengths are specified in the power optimizer datasheets. Refer to the [Designer](#) for string length verification.



1. Connect the Minus (-) output connector of the string's first power optimizer to the Plus (+) output connector of the string's second power optimizer. When connecting S-Series Power Optimizers, be sure to connect the short Minus (-) output connector of one Power Optimizer to the long Plus (+) output connector of the next Power Optimizer.
2. To minimize electromagnetic interference (EMI), make sure to minimize the distance between the positive and negative DC cables.

For detailed instructions, see:

<https://www.solaredge.com/sites/default/files/se-emi-performance-application-note.pdf>.



3. Connect the rest of the power optimizers in the string in the same manner.



WARNING!

If using a dual-input power optimizer and some inputs are not used, seal the unused input connectors with the supplied pair of seals.

4. If you intend to monitor the installation, using the monitoring platform, record the physical location of each power optimizer, as described in *Creating Logical and Physical Layout using Installation Information* on page 51

Step 4: Verifying Proper Power Optimizer Connection

When a module is connected to a Power Optimizer, the Power Optimizer outputs a safe voltage of 1V ($\pm 0.1V$). Therefore, the total PV string voltage should equal 1V times the number of Power Optimizers connected in series in the PV string. For example, if 10 Power Optimizers are connected in a PV string, then 10V should be produced.

Make sure the PV modules are exposed to sunlight during this process. The Power Optimizer will only turn ON if the PV module provides at least 2W.

In SolarEdge systems, due to the introduction of Power Optimizers between the PV modules and the inverter, the short circuit current I_{SC} and the open circuit voltage V_{OC} hold different meanings from those in traditional systems.

For more information about the SolarEdge system's PV string Voltage and current, refer to the *V_{OC} and I_{SC} in SolarEdge Systems Technical Note*, available on the SolarEdge website at:

https://www.solaredge.com/sites/default/files/isc_and_voc_in_solaredge_sytems_technical_note.pdf



→ To verify proper Power Optimizer connection:

- Measure the voltage of each PV string individually before connecting it to the other PV strings or to the inverter. Verify correct polarity by measuring the PV string polarity with a voltmeter. Use a voltmeter with at least 0.1V measurement accuracy.



NOTE

Since the inverter is not yet operating, you may measure the PV string Voltage and verify correct polarity on the DC wires. inside the .

For troubleshooting Power Optimizer operation problems, refer to *Power Optimizer Troubleshooting* on page 56.

Proper Power Optimizer connection can also be verified in the Designer application.

For more information, refer to

<https://www.solaredge.com/products/installer-tools/designer#/>.



Chapter 3: Installing the Inverter

Install the inverter either before or after the modules and power optimizers have been installed.



CAUTION!

Do not rest the connectors at the bottom of the inverter on the ground, as it may damage them. To rest the inverter on the ground, lay it on its back.

Inverter Package Contents

- SolarEdge Home Hub Inverter - Three Phase with pre-installed Home Network and Antenna
- Wall mounting bracket
- DC connection box (DC kit)
- Antenna bracket with its two screws
- Two screws for securing the inverter to the wall bracket
- Two screws for grounding
- One ferrite bead for the AC cable
- Two-three cable holder stickers
- Four springs
- Two nuts
- Two shoe cables
- Compact installation guide

Identifying the Inverter

Refer to the sticker on the inverter that specifies its **Serial Number** and its **Electrical Ratings**. Provide the serial number when contacting SolarEdge support. The serial number is also required when opening a new site in the SolarEdge monitoring platform.

Unpacking the inverter

- Extract the inverter out of the carton box following the on-package instruction.



CAUTION!

Do not place the inverter vertically on the ground as this may damage the connectors.

Inverter Interfaces

The following figure shows the inverter connectors and components, located at the bottom of the inverter.

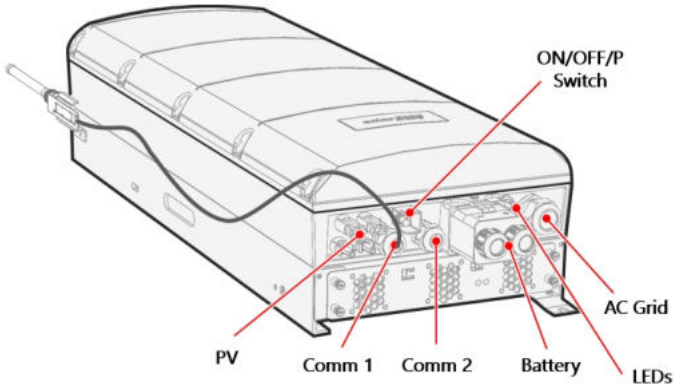

Figure 5: Inverter Interfaces

- **AC grid gland:** AC output gland Ø15–21mm.
- **PV input connectors:** Two pairs of MC4 connectors.
- **Two communication glands:** for connection of inverter communication options. Each gland can accommodate 2 CAT 5E cables and a single RF antenna cable provided as accessory kit from SolarEdge.
- **Battery DC kit:** includes two battery shoe cables for connecting charging cables (+ and -), supplied in the inverter kit and but mounted. For mounting instructions, refer to *Connecting the DC cable and the grounding cable* on page 33.
- **ON/OFF/P switch**
Refer to *Activating, Commissioning and Configuring the System* on page 37
- **LEDs**
Refer to *Activating, Commissioning and Configuring the System* on page 37

Mounting the Inverter

The inverter is supplied with a mounting bracket.

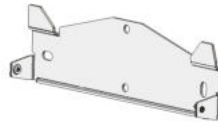

Figure 6: Mounting bracket

NOTE



Make sure the mounting surface or structure can support the weight of the inverter and bracket, and make sure that it spans the width of the bracket.

CAUTION!



HEAVY OBJECT. To avoid muscle strain or back injury, use proper lifting techniques, and if required - a lifting aid.

CAUTION!

SolarEdge inverters and Power Optimizers can be installed at a minimum distance of 50 m from the shoreline of an ocean or other saline environment, as long as there are no direct salt water splashes on the inverter or Power Optimizer.



For SolarEdge inverters installed at a distance of 200 m or closer to the shoreline, special brackets must be purchased separately from SolarEdge and SS304 stainless screws are required. For details, please contact your local sales representative.

1. Determine the inverter mounting location, on a wall, stud framing or pole. It is recommended to mount the inverter in a location protected from direct sunlight.
2. To allow for proper heat dissipation, follow the guidelines specified in *Application Note - Clearance Guidelines*.

<https://www.solaredge.com/sites/default/files/se-clearance-guidelines-for-multiple-inverter-mounting.pdf>



Maintaining proper clearance between the inverter and other objects prevents power reduction due to excessive temperature.

3. Position the mounting bracket against the wall/pole, level it, and mark the drilling hole locations. :
 - Ensure that the flat edge of the bracket is at the bottom, as in *Figure 8*.
 - Use at least two outer bracket holes to secure the mounting bracket, if you wish to use more, determine which and how many holes to use according to mounting surface type and material.
4. Drill the holes and mount the bracket. Verify that the bracket is leveled and firmly attached to the mounting surface.

NOTE

When mounting an inverter on an uneven surface, you may use spacers/washers behind the top mounting hole of the bracket. Depending on the angle, use the appropriate size and number of spacers so that the bracket is perpendicular to the ground.

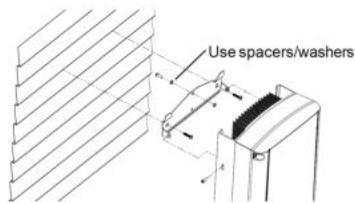

Figure 7: Mounting on uneven surfaces

5. Hang the inverter on the bracket (see *Figure 8*): Lift the inverter from the sides, or hold it at the top and bottom of the inverter to lift the unit into place.
6. Align the two indentations in the inverter enclosure with the two triangular mounting tabs of the bracket, and lower the inverter until it rests on the bracket evenly.

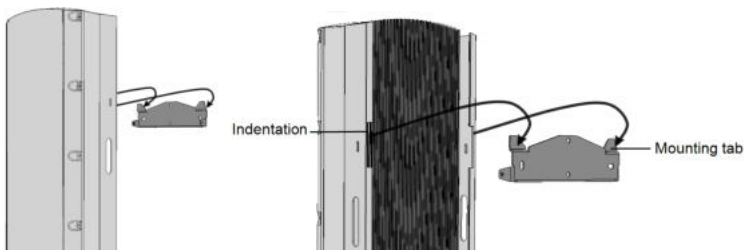

Figure 8: Hanging the inverter on the bracket

7. Insert the two supplied screws through the outer heat sink fins on both sides of the inverter and into the bracket (see *Figure 8*).

Tighten the screws with the torque of 4.0 N*m / 2.9 lb.*ft.

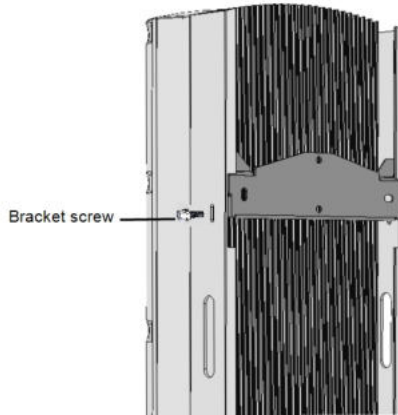

Figure 9: Inserting the bracket screws

Selecting a Residual Current Device (RCD)

The Inverter supports both type A and Type B RCD. For information on Residual Current Device, refer to the *RCD Selection for SolarEdge Inverters Application Note*, available on the SolarEdge website at http://www.solaredge.com/sites/default/files/application_note_ground_fault_rcd.pdf.



Chapter 4: Installing the Battery

Install the battery in accordance with the manufacturer instructions.

In addition, follow these guidelines:

- Make sure the battery's circuit breaker switch is OFF.
- Measure the necessary length between the inverter and the battery for all cables. Maximum length is 5m.
- Mark polarity on DC cables. The red cable (+) needs to be connected to the red connectors, or to the connectors marked with "+". The black cable (-) needs to be connected to the black connectors, or to the connectors marked with "-".

Chapter 4: Installing the BUI

Refer to BUI (Backup User Interface) installation manual

[se-home-backup-interface-three-phase-quick-installation-guide.pdf](#)



Chapter 5: Connecting the Inverter

This chapter explains how to connect the inverter to:

- AC grid
- DC strings of modules with power optimizers
- Energy Meter
- Battery

Opening the Inverter Cover

1. Switch the inverter ON/OFF/P switch to OFF. Wait 5 minutes for the capacitors to discharge.
2. Disconnect AC to the inverter by turning off the circuit breaker on the distribution panel.
3. Turn off the battery.
4. Using Allen 4 mm key, loosen all bolts of the inverter cover half a turn.

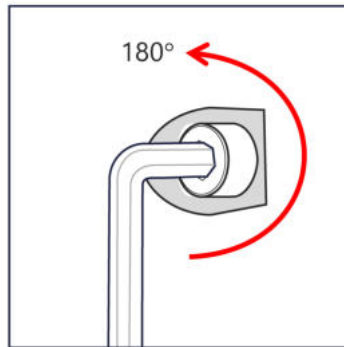

Figure 10: Loosening the bolts

- Release all bolts fully, use the following sequence for opening and closing the inverter cover.



Figure 11: Opening and closing sequence

- Carefully remove the inverter cover: pull the cover horizontally before lowering it.

Connecting PV Strings to the Inverter

Connect the homerun cables from the PV strings to the PV input connectors (MC4).

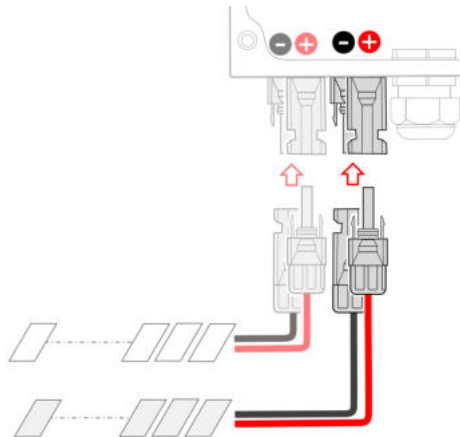

Figure 12: Connecting the PV strings

If required, connect the strings to an external combiner box. Then, connect the DC cables from the combiner box to the inverter's DC input connectors.

NOTE

Functional electrical earthing of DC-side negative or positive poles is prohibited because the inverter has no transformer. Grounding (earth ground) of module frames and mounting equipment of the PV string modules is acceptable.

NOTE

SolarEdge fixed input voltage architecture enables the parallel strings to be of different lengths. Therefore, they do not need to have the same number of Power Optimizers, as long as the length of each string is within the permitted range.

Connecting the Battery

Connecting the communication cable

First, connect the communication cable between the battery tower and the inverter. Communication cable uses CAN bus communication protocol.

1. Open the communication gland and pass the CAN bus connector and the communication cable through the gland. Note the cable size and the gland pass-through.

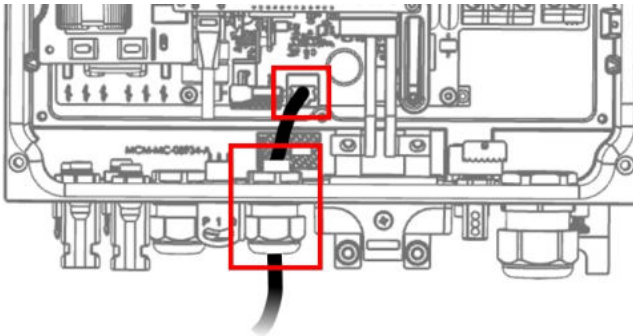

Figure 13: Battery communication cable

2. Connect the cable to the CAN bus connector located next to the gland.

Connecting the AC grid cable

Use a five-wire cable. The maximum wire size for the input terminal blocks is 6 mm².

1. Open the AC Gland, insert the cable through the gland and through the ferrite bead (supplied with the Inverter).

2. Recommended cable diameter is 15-21, recommended cable cross-section is between 4-6mm².
3. Strip around up to 8-9mm of the internal wire and crimp the edge with ferrule.

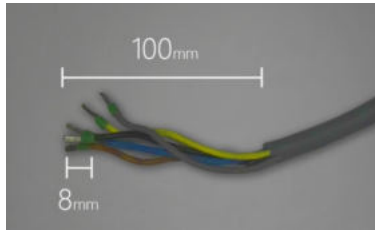

Figure 14: Wire ferrule

4. Connect the AC cable to the AC terminals. Note the marking on the connectors. Connect the PE wire first. Note that in case of multiple inverters installation, you **MUST** connect all the phases accordingly e.g. if the brown is L1, it should be L1 on all inverters connected on this installation.
5. Strip up to 8mm of the internal wire and crimp the edge with ferrule.

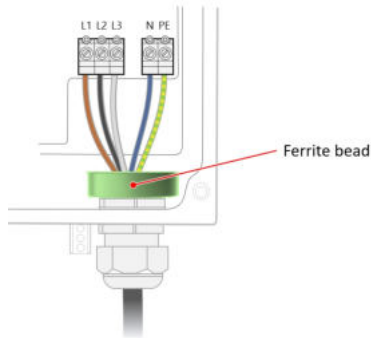

Figure 15: AC cable

**NOTE**

Connect the PE (grounding) wire first.

6. Tighten the connection screws. Check that the wires are fully inserted and cannot be pulled out easily.
7. Tighten the AC cable gland.

Connecting the DC cable and the grounding cable

1. Before making any connection to the inverter, make sure that all battery CBs are OFF.
2. Take the DC connection kit out of the box.
3. Open the cable gland nuts on the connection kit and pass the Battery DC cables (already crimped with the symmetric ring terminal supplied by SolarEdge) through the gland. Note that the polarity is indicated on the connection kit, make sure that the snap is facing you. Make sure the sealing ring (shown below in gray) is in place and intact.



Figure 16: Connection kit

4. Connect the battery DC cables to their connectors on the inverter side. First, assemble the symmetric ring terminals supplied by SolarEdge, then the flat washer, then the spring, and finally place the nut. Use torque of $8\text{N}\cdot\text{m}$.

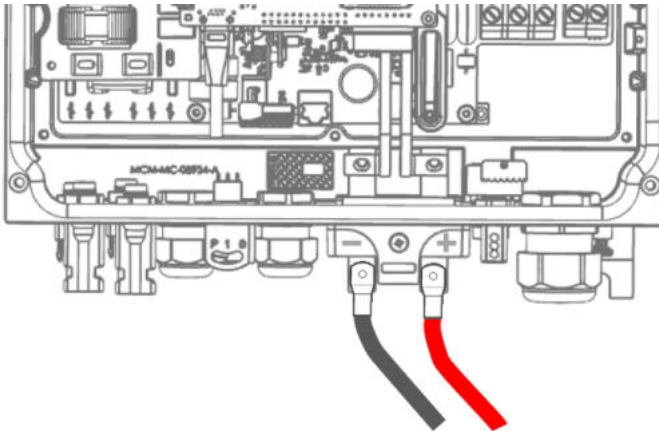

Figure 17: DC cables

5. Open the securing screw, but not all the way, just enough so the connection kit may pass without damaging the sealing ring. You will feel with the finger if the screw is not interfering the box insertion.

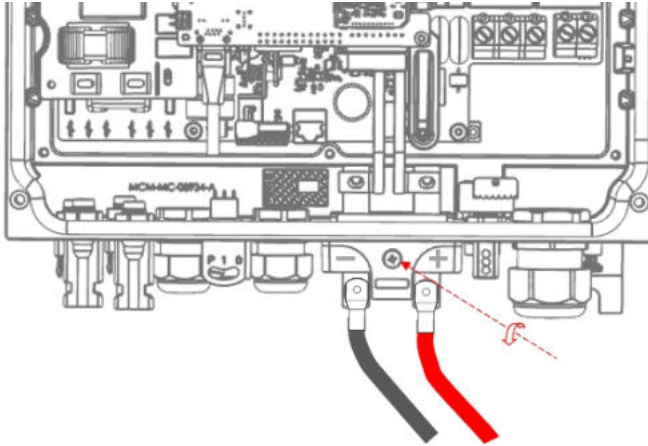

Figure 18: Securing screw

6. Insert the kit box until you hear a click.

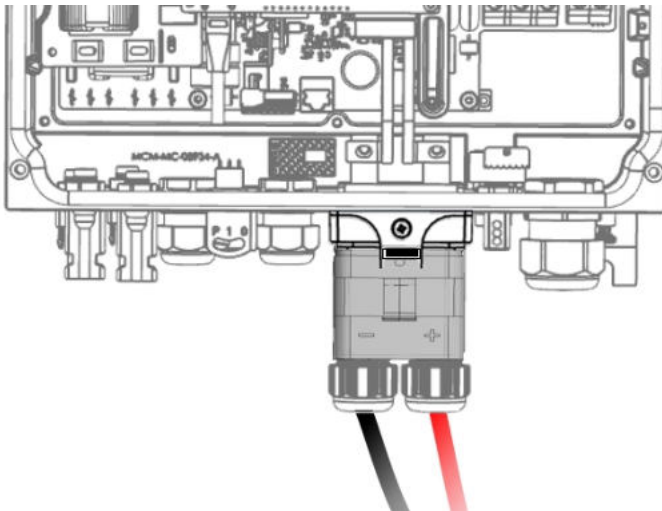

Figure 19: Connection kit box

7. Fasten the securing screw using the torque of 2.2N*m.
8. Close the glands.
9. Depending on the local regulation, connect the battery grounding cable either to the inverter (then use the screw shown below), or to the home ground utility. The grounding cable cross-section must match the DC cable cross-section as follows: if Phase and Neutral are less than 10mm², use 6mm²; if Phase and Neutral are up to 35mm², use 16mm² for grounding.

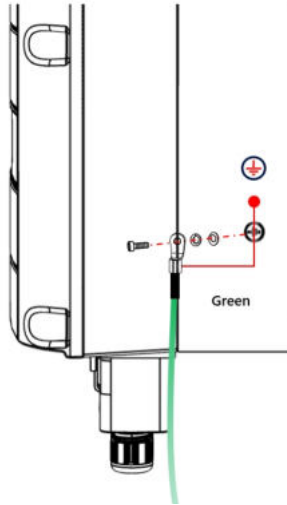

Figure 20: Grounding cable

NOTE

Before closing the cover, set up communication with the monitoring platform -- refer to *Setting Up Communication with the Monitoring Platform* on page 41

Closing the Inverter Cover

1. Mount the cover.
2. Fasten all bolts slightly with a hand, so that they hold the cover.

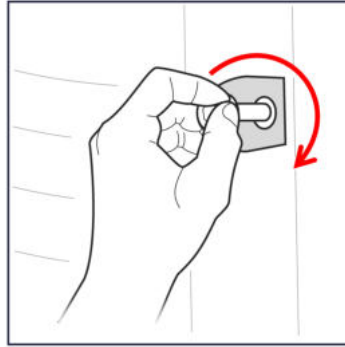

Figure 21: Fastening the bolts

3. Fasten all bolts to a torque of 4 N*m in the order shown below. Use the same sequence that was used for opening.

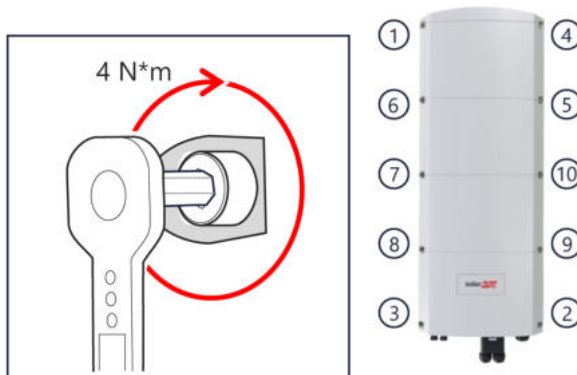

Figure 22: Closing and opening sequence

Chapter 6: Activating, Commissioning and Configuring the System

After the solar system is installed, it is important to activate and commission the solar system. Activation and commission of the system is performed using the inverter SetApp mobile application.

During the activation and commissioning, the inverter discovers and communicates with all connected components in the solar system, such as: optimizers, peripheral communication devices and other linked inverters. When commissioning is performed, the user is required to set the grid parameters and backup Voltage information (if used).

Before starting the activation and commissioning, verify the all the communication hardware is properly connect. For communication options, refer to: *Setting Up Communication with the Monitoring Platform* on page 41.

Before arriving at the site, download SolarEdge SetApp application to your mobile device from Apple App Store or Google Play .

Before activation and commissioning, download the SetApp application from:



For downloading SetApp, Internet connection, one-time registration and logging are required. No registration is required for using the SetApp.

Step 1: Activating the Installation

During system activation, a Wi-Fi connection is created between the mobile device and the inverter and the system firmware is upgraded.

Before activation

- Download, register (first time only) and login to SetApp on your mobile device. Verify that the application is updated with the latest version.

- If applicable, turn on all devices (battery, Energy Meter) connected to the inverter, so that the devices may be auto-detected.

→ **To activate the inverter:**

1. Turn-on the AC circuit breaker on the main distribution panel.
2. Turn-on the DC Disconnect Switch (if applicable).
3. Open SetApp and follow the on-screen instructions (scan the inverter barcode; move the ON/OFF/P switch to P position for 2 seconds and release).
SetApp creates a Wi-Fi connection, upgrades the inverter firmware and activates the inverter.
4. When the activation is complete, do one of the following:
 - Select **Connect to Another Device** to continue activating additional inverters.
 - Select **Start Commissioning** for pairing and other system configuration.

Step 2: Commissioning and Configuring the Installation

This section describes how to use the SetApp menus for commissioning and configuring the inverter settings.

Menus may vary in your application depending on your system type.

→ **To access the Commissioning screen:**

Do one of the following:

- During first time installation: Upon activation completion, in the SetApp, tap **Start Commissioning**.
- If the inverter has already been activated and commissioned:
 - If not already ON - turn ON AC to the inverter by turning ON the circuit breaker on the main distribution panel.
 - Open SetApp and follow the on-screen instructions (scan the inverter QR code, move the ON/OFF/P switch to P position for 2 seconds and release).
The mobile device creates a Wi-Fi connection with the inverter and displays the main Commissioning screen.

Setting Country, Grid and Language

The inverter must be configured to the proper settings in order to ensure that it complies with the country grid code and functions. Unless these settings are selected, the inverter will not start production.

1. From the **Commissioning** screen, select **Country & Grid**.
2. From the **Country & Grid** drop-down list, select the required option and tap **Set Country & Grid**.
3. If relevant, from the **Language** drop-down list, select your language and tap **Set Language**.
4. To save the information to a read-only file, tap the **PDF** icon (iOS) or the **JPEG** icon (Android) at the bottom of the screen.

Pairing

1. From the **Commissioning** menu, select **Pairing**.
2. Tap **Start Pairing**.
3. When **Pairing Complete** is displayed, the system startup process begins:
Since the inverter is ON, the Power Optimizers start producing power and the inverter starts converting AC.

WARNING!



When you turn ON the inverter ON/OFF/P switch, the DC cables carry a high Voltage and the Power Optimizers no longer output a safe output.

When the inverter starts converting power after the initial connection to the AC, the inverter enters Wake up mode until its working voltage is reached. This mode is indicated by the flickering green inverter LED.

When working voltage is reached, the inverter enters Production mode and produces power. The steadily lit green inverter LED indicates this mode.

4. Tap **OK** to return to the **Commissioning** menu.

Communication

Communication settings can be configured only after communication connections are complete. Refer to *Setting Up Communication with the Monitoring Platform* on page 41.

- From the Commissioning menu, select **Monitoring Communication** > **Auto Select**. SetApp will automatically detect your connection method. Follow the on-screen instructions to complete the configuration and establish communication with the monitoring platform.
- From the Commissioning menu, Select **Site Communication** to configure communication between multiple SolarEdge devices or external non SolarEdge devices, such as batteries or data loggers.

For more information on the Monitoring Platform, refer to "The Monitoring Platform" section and to the Monitoring Platform web page at:

<https://www.solaredge.com/products/pv-monitoring/>

Power Control

Power control options are detailed in the *Power Control Application Note*, available on the SolarEdge website at: https://www.solaredge.com/sites/default/files/application_note_power_control_configuration.pdf.

The Grid Control option may be disabled. Enabling it opens additional options in the menu.

The Energy Manager option is used for setting power export limitation, as described in the *Export Limitation Application Note*, available on the SolarEdge website at: https://www.solaredge.com/sites/default/files/feed-in_limitation_application_note.pdf.

Step 3: Verifying Proper Activation and Commissioning

1. Select **Information** and verify that the correct firmware versions are installed on each inverter.
2. Select **Status** and verify that inverter is operating and producing power.
3. Verify that additional configurations were properly set by viewing the relevant Status screens.
4. Verify that the green inverter LED is steadily lit.

Your SolarEdge power harvesting system is now operational.

Chapter 7: Setting Up Communication with the Monitoring Platform

The inverter sends the following information to the monitoring platform:

- Power Optimizer information received via the DC power lines (the PV output circuit)
- Inverter information
- Information of any other connected devices

This chapter describes how to set up communication between:

- The inverter and the monitoring platform through the Internet (wired/ wireless)
- Multiple inverters for a leader-follower configuration

Communication setup is not required for power harvesting, however it is needed for using the monitoring platform.



CAUTION!

Communication Options

The following types of communication can be used to transfer the monitored information from the inverter to the monitoring platform.

Only communication products offered by SolarEdge are supported.

Ethernet

Ethernet is used for a LAN connection.

RS485

RS485 is used for the connection of multiple SolarEdge inverters on the same bus in a leader-follower configuration. RS485 can also be used as an interface to external devices, such as meters and third party data loggers.

Wi-Fi

This communication option enables using a Wi-Fi connection for connecting to the monitoring platform.

The Wi-Fi access point is built into the inverter. An antenna is required and available from SolarEdge for connection to the monitoring platform.

Wireless Gateway, Wireless Repeater(s)

The Wireless Gateway collects inverter data using a dedicated Wi-Fi connection and connects to the monitoring platform with the help of a home router. Wireless Repeater(s) extend the Wi-Fi signal range between the Wireless Gateway and inverter. Wireless Gateway and Wireless Repeaters can be purchased separately from SolarEdge. For more information, refer to <https://www.solaredge.com/sites/default/files/se-wireless-gateway-wireless-repeater-installation-guide.pdf>.



Cellular

This wireless communication option enables using a cellular connection to connect one or several devices (depending on the data plan used) to the monitoring platform.

The Cellular Plug-in is provided with a user manual, which should be reviewed prior to connection. Refer to <https://www.solaredge.com/sites/default/files/se-cellular-plug-in-for-inverters-with-setapp-installation-guide.pdf>



SolarEdge Home Network

SolarEdge Home Hub Inverter comes with a pre-installed SolarEdge Home Network communication board and antenna. This wireless communication option enables connecting one or more SolarEdge Home Network enabled devices to inverter with an installed SolarEdge Home Network plug-in.

The SolarEdge Home Network plug-in is provided with a user manual which should be reviewed prior to connection. Refer to:

<https://www.solaredge.com/sites/default/files/se-energy-net-plug-in-installation-guide.pdf>



ZigBee

This option enables wireless connection to one or several Smart Energy products, which automatically divert PV energy to home appliances.

The Smart Energy ZigBee connections require a ZigBee plug-in and an external antenna, available from SolarEdge.

The ZigBee Plug-in for Smart Energy is provided with an installation guide, which should be reviewed prior to connection. Refer to <https://www.solaredge.com/sites/default/files/se-zigbee-plug-in-for-setapp-installation-guide.pdf>

The Smart Energy products are provided with an installation guide, which should be reviewed prior to connection. Refer to [https://www.solaredge.com/products/device-control#./](https://www.solaredge.com/products/device-control#/).



Creating an Ethernet (LAN) Connection

This communication option enables using an Ethernet connection to connect the inverter to the monitoring platform through a LAN.

Ethernet cable specifications:

- Cable type – a shielded Ethernet cable (CAT5E or CAT6) may be used
- Maximum distance between the inverter and the router – 100 m/ 330 ft.

NOTE

If using a cable longer than 10 m / 33 ft in areas where there is a risk of induced voltage surges by lightning, SolarEdge recommends using external surge protection devices to prevent damage to the inverter.

For details refer to:

http://www.solaredge.com/files/pdfs/lightning_surge_protection.pdf.



→ To connect the Ethernet cable as described above:

1. Remove the inverter cover as described in *Mounting the Inverter* on page 24.
2. Open Communication Gland 1.



CAUTION!

The gland includes a rubber waterproof fitting, which should be used to ensure proper sealing.

3. Remove the plastic seal from one of the large openings.
4. Remove the rubber fitting from the gland and insert the CAT6 cable through the gland and through the gland opening in the inverter.
5. Push the cable into the cut opening of the rubber fitting.

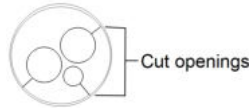

Figure 23: Rubber fitting

CAT6 standard cables have eight wires (four twisted pairs), as shown in the diagram below. Wire colors may differ from one cable to another. You can use either wiring standard, as long as both sides of the cable have the same pin-out and color-coding.

RJ45 Pin #	Wire Color ⁽¹⁾		10Base-T Signal 100Base-TX Signal
	T568B	T568A	
1	White/Orange	White/Green	Transmit+
2	Orange	Green	Transmit-
3	White/Green	White/Orange	Receive+
4	Blue	Blue	Reserved
5	White/Blue	White/Blue	Reserved
6	Green	Orange	Received-
7	White/Brown	White/Brown	Reserved
8	Brown	Brown	Reserved

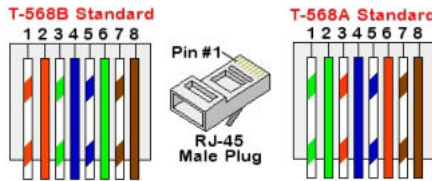

Figure 24: Standard cable wiring

6. Use a pre-terminated cable to connect via gland #1 to the RJ45 plug on the inverter's communication board or, if using a spool of cable, connect as follows:
 - a. Insert the cable through Communication Gland 1.
 - b. Remove the cable's external insulation using a crimping tool or cable cutter and expose eight wires.
 - c. Insert the eight wires into an RJ45 connector, as described in *Figure 24*.

⁽¹⁾The inverter connection does not support RX/TX polarity change. Supporting crossover Ethernet cables depends on the switch capabilities.

- d. Use a crimping tool to crimp the connector.
- e. Connect the Ethernet connector to the RJ45 port on the communication board.

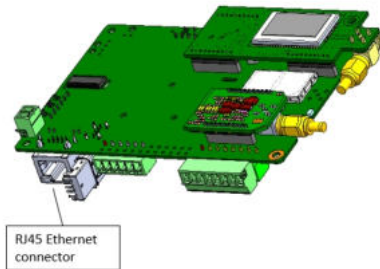

Figure 25: RJ45 Ethernet connection

7. For the switch/router side, use a pre-crimped cable or use a crimper to prepare an RJ45 communication connector: Insert the eight wires into the RJ45 connector in the same order as above (*Figure 24*).
8. Connect the cable RJ45 connector to the RJ45 port of the Ethernet switch or router. You can connect more than one inverter to the same switch/router or to different switches/routers, as needed. Each inverter sends its monitored data independently to the monitoring platform.
9. The inverter is configured by default to LAN. If reconfiguration is required:
 - a. Make sure the ON/OFF/P switch is OFF.
 - b. Turn ON the AC to the inverter by turning ON the circuit breaker on the main distribution panel.
 - c. Configure the connection as described in *Communication* on page 40.

NOTE



If your network has a firewall, you may need to configure it to enable the connection to the following address:

- Destination Address: prodssl.solaredge.com
- TCP Port: **443** (for incoming and outgoing data)

10. Verify the connection, as described in *Verifying the Connection* on page 49.

Creating RS485 Bus Connection

The RS485 option enables creating a bus of connected inverters, consisting of up to 31 follower inverters and 1 leader inverter. Using this option, inverters are connected to each other in a bus (chain), via their RS485 connectors. The first and last inverters in the chain must be terminated as described on page 47.

RS485 wiring specifications:

- Cable type: CAT6 and higher with shielding protection of the twisted pairs of wires and an outer foil or braided shielding
- Wire cross-section area: 0.2- 1mm²
- Maximum nodes: 32
- Maximum distance between first and last devices: 1000m.

The following sections describe how to physically connect the RS485 bus and how to configure the bus.

→ **To connect the RS485 communication bus:**

1. Remove the inverter cover, as described *Mounting the Inverter* on page 24.
2. Open Communication Gland and insert the cable through one of the openings.
3. Remove the connector from the RS485-2 port, as shown below, and loosen its screws.

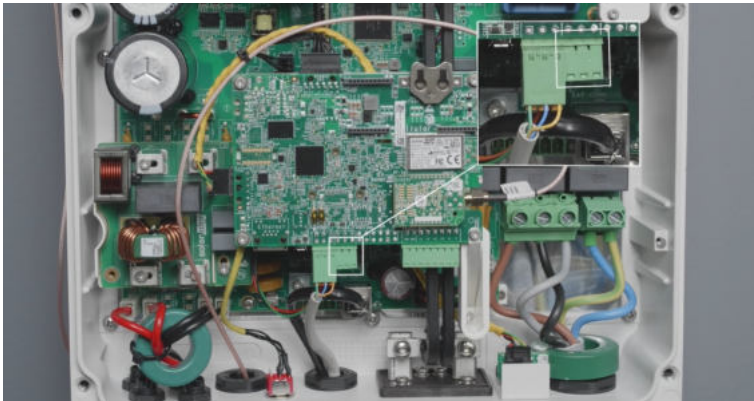

Figure 26: RS485 connector on the communication board

4. Insert the wire ends into the **B**, **A** and **G** opening on the connector.
You can use any color wire for each of the **B**, **A** and **G** connections, as long as:

- The same color wire is used for all A pins the same color for all B pins and the same color for all G pins
 - The wire for G is not from the same twisted pair as A or B.
5. For creating an RS485 bus, connect all B, A and G pins in all inverters.

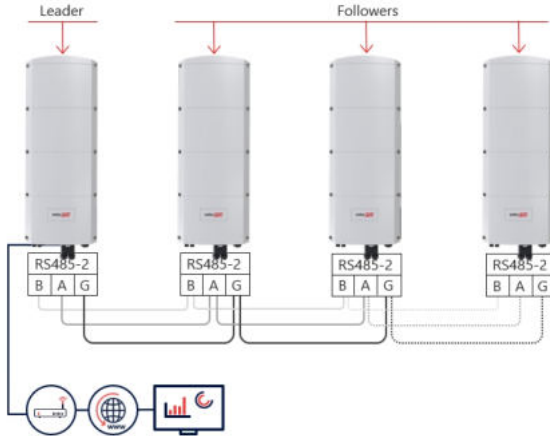

Figure 27: Connecting the inverters in a chain



NOTE

Do not cross-connect B, A and G wires.

6. Tighten the connector screws.
7. Check that the wires are fully inserted and cannot be pulled out easily.
8. Connect the RS485-2 connector to the RS485 port on the communication board.
9. Terminate the first and last SolarEdge inverter in the chain. The inverter can be terminated by switching on (up) the left DIP switch on the communication board.

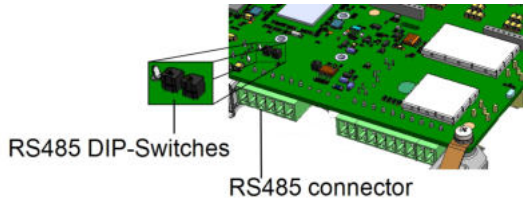

Figure 28: RS485 termination switch

NOTE



Only the first and last SolarEdge inverter in the chain must be terminated. In the other inverters in the chain, the DIP switch must be in the off (down) position.

10. If no surge protection is used, connect the grounding wire to the first inverter in the RS485 chain; make sure the grounding wire is not in contact with other wires. For inverters with a Home Hub Connection Unit, connect the grounding wire to the grounding bus-bar in the Home Hub Connection Unit.

RS485 Bus Configuration

→ To connect to the monitoring platform:

1. Designate a single inverter as the connection point between the RS485 bus and the monitoring platform. This inverter will serve as the leader inverter.
2. Connect the leader to the monitoring platform using Ethernet (refer to *Creating an Ethernet (LAN) Connection* above).

→ To configure the RS485 bus:

All inverters are configured by default as followers. The *leader* is the inverter connected to the Home network and the one that the meter **MUST** be connected to. To configure the leader:

1. Make sure the inverter's ON/OFF/P switch is off.
2. Make sure that the AC circuit breaker on the main distribution panel is on.
3. Access SetApp, as described in *Communication* on page 40.
4. From the **Commissioning** screen, select **Site Communication** > **RS485-** > **Protocol** > **SolarEdge** > **SolarEdge Leader**.
5. Return to the **RS485-** screen and select **Follower Detect**.
The system starts automatic detection of the follower inverters connected to the leader inverter. The inverter should report the correct number of followers. If it does not, verify the connections and terminations in all inverters in the chain.
6. To check the follower IDs and last communication time, select **RS485-** > **Follower List**.
7. Verify the connection of the leader to the monitoring platform, as described below.

Verifying the Connection

After connecting and configuring a communication option, perform the following steps to check that the connection to the Monitoring platform has been successfully established.

1. Commission the inverter as describe in "**Activating, Commissioning and Configuring the System**" on page 37.
2. Access SetApp and select **Status** from the **Configuring** screen.
3. In the **Summary** section, under **Server Comm.**, make sure **S_OK** is displayed together with the selected communication option.
4. Scroll down to the **Communication** section and check that the communication options are as required.

Reporting and Monitoring Installation Data

Monitoring the site requires connecting the inverter to the monitoring platform, using any of the wired or wireless options available from SolarEdge. Refer to *Setting Up Communication with the Monitoring Platform* on page 41.

The Monitoring Platform

The monitoring platform provides enhanced PV performance monitoring and inverter yield assurance through immediate fault detection and alerts at the module, PV array and system level.

Using the platform, you can:

- View the latest performance of specific components.
- Find under-performing components, such as modules, by comparing their performance to that of other components of the same type.
- Pinpoint the location of alerted components using the physical layout.

The monitoring platform enables accessing site information, including up-to-date information viewed in a physical or logical view:

- **Logical Layout:** Shows a schematic tree-layout of the components in the system, such as: inverters, Power Optimizers, PV arrays, modules, meters and sensors, as well as their electrical connectivity. This view enables you to see which modules are connected in each PV array, which PV arrays are connected to each inverter, and so on.
- **Physical Layout:** Provides a bird's eye view of the actual placement of modules in the site, and allows pinpoint issues to the exact location of each module on a virtual site map.

If you do not report the mapping of the installed Power Optimizers, the monitoring platform will show the logical layout, indicating which Power Optimizers are connected to which inverter, but will not show PV strings or the physical location of Power Optimizers.

The monitoring platform includes a built-in help system that guides you through the monitoring functionality.

For more information, refer to <https://www.solaredge.com/products/pv-monitoring#/>.

Creating Logical and Physical Layout using Installation Information

To display a logical layout, insert the inverter serial number in the new site created in the monitoring platform. When the communication between the inverter and the monitoring server is established, the logical layout is displayed.

To display a physical layout, you need to map the locations of the installed power optimizers. To map the locations, use one of the methods described in the next sections.

Designer

Designer recommends inverter and Power Optimizer selection per site size and enables report generation. You can create a project in Designer and export the site design with the PV array layout to the monitoring platform.

For more information, refer to <https://www.solaredge.com/products/installer-tools/designer#/>.

Mapper Application

Use the Mapper smart phone application to scan the Power Optimizer and inverter 2D barcodes and create a virtual map of a PV site for enhanced monitoring and easier maintenance.

The Mapper application is integrated with the Monitoring platform and enables:

- Simple on-site registration of new systems.
- Creating, editing and verifying system physical layout.
- Scanning and assigning the Power Optimizer serial number to the correct module in the system physical layout.

For detailed information, refer to the *Mapper* demo movies:

- [Creating new sites using the Mapper mobile application](#)
- [Mapping existing sites using the Mapper mobile application](#)

Physical Layout Editor

1. If you are a registered installer, access the monitoring platform site creation page at <https://monitoring.solaredge.com/solaredge-web/p/home#createSites>. If you have not yet signed up, go to <https://monitoring.solaredge.com/solaredge-web/p/createSelfNewInstaller>.

2. Fill out all required information in the screen, which includes information about your installation, as well as details about its logical and physical mapping.

Appendix A: Errors and Troubleshooting

This appendix describes general system problems, and how to troubleshoot them. For further assistance, contact SolarEdge Support.

Identifying Errors

Errors may be indicated in various system interfaces: On the inverter bottom panel, a red LED indicates an error. In the monitoring platform and SetApp, errors are displayed with codes.

For more information on the codes displayed for error and warning messages, refer to <http://www.solaredge.com/sites/default/files/se-inverter-installation-guide-error-codes.pdf>. This document describes errors that appear in SetApp, monitoring platform, and LCD (for inverters with LCD). To identify the error types, use the methods described below.



→ To identify the error type using the inverter LEDs:

1. Move the ON/OFF/P switch to **P** position for **2 seconds** and release it.
2. Observe the LED lights and use the following table to identify the error type. For more information, refer to:

<https://www.solaredge.com/leds>



Error Type	Inverter LED Color and State		
	Red	Green	Blue
Arc detected	ON	OFF	OFF
Isolation or RCD problem	Blinking	OFF	OFF
Grid error	OFF	ON	OFF
High temperature	OFF	Blinking	OFF
Pairing failed	OFF	OFF	ON
Other issue	OFF	OFF	Blinking

→ To identify the error type using the monitoring platform:

1. Open the site dashboard and click the **Layout** icon.
2. Right-click the inverter and select **Info** from the menu. The inverter details window is displayed.
3. Click the **Errors** tab. The list is displayed.

Troubleshooting Communication

Troubleshooting Ethernet (LAN) Communication

The possible errors and their troubleshooting are detailed in the following table:

Error Message	Possible Cause and Troubleshooting
LAN cable disconnected	Physical connection fault. Check the cable pin-out assignment and cable connection.
No DHCP	IP settings issue. Check the router and inverter configuration. Consult your network IT.
Configure Static IP or set to DHCP	
Gateway not responding	Ping to router failed. Check the physical connection to the switch/ router. Check that the link LED at the router /switch is lit (indicating phy-link). If OK - contact your network IT, otherwise replace the cable or change it from cross to straight connection.
No Internet connection	Ping to google.com failed. Connect a laptop and check for internet connection. If internet access is unavailable, contact your IT admin or your internet provider. For Wi-Fi networks, ensure that user-name and password are as defined in the internet provider AP/ router.

Troubleshooting RS485 Communication

- If the message **RS485 Leader Not Found** appears in the Status screen, check the connections to the leader device and fix if required.
- If after follower detection the number of followers displayed for the leader under **RS485- > Follower Detect** is lower than the actual number of followers, refer to the following application note to identify missing followers and troubleshoot connectivity problems:
https://www.solaredge.com/sites/default/files/troubleshooting_undetected_RS485_devices.pdf

Additional Troubleshooting

1. Check that the modem or hub/router is functioning properly.
2. Check that the connection to the internal connector on the communication board is properly done.
3. Check that the selected communication option is properly configured.
4. Use a method independent of the SolarEdge device to check whether the network and modem are operating properly. For example, connect a laptop to the Ethernet router and connect to the Internet.
5. Check whether a firewall or another type of network filter is blocking communication.

SolarEdge Home Hub Inverter - Three Phase Troubleshooting

Error Code	Error Message	Possible Cause and Troubleshooting
1Dx7D	High battery voltage	Verify that the battery is connected to the inverter as required.
1Dx7E	Low battery voltage	Verify that the battery is connected to the inverter as required.
1Dx88	Internal communication error	Verify that the RS485 connector on the communication board is connected as required.
1Dx89	Internal DC power connection error	Verify that the connection between the DCDC PCB and the inverter PCB is connected as required.
1Dx8A	High DC voltage fault	Verify that the connection between the DCDC PCB and the inverter PCB is connected as required and check for short in string - inverter power connection.
1Dx8D	High battery voltage	Verify that the battery is connected to the inverter as required.
1Dx8E	Low battery voltage	Verify that the battery is connected to the inverter as required
1Dx9F	Battery communication error	Verify that the CAN connectors are connected as required.

1DxA0	Battery error	Call battery vendor support.
1DxA1	Battery not selected	Configure battery as required.
1DxA2	Operation conditions verification failed	Verify that the battery is connected to the inverter as required, battery voltage is within range and the battery is enabled (power and communication).

Power Optimizer Troubleshooting

Malfunction	Possible Cause and Corrective Action
Pairing failed	<p>Power Optimizers are shaded.</p> <p>If you connected the inverter to the monitoring platform, retry pairing remotely (during sunlight). Make sure to leave the inverter ON/OFF/P switch ON and that S_OK appears in the status screen.</p>
PV string Voltage is 0V	<p>Power Optimizer (s) output is disconnected.</p> <p>Connect all Power Optimizer outputs.</p>
PV string voltage not 0V but lower than number of Power Optimizers	<p>Power Optimizer(s) not connected in the PV string.</p> <p>Connect all Power Optimizers.</p>
	<p>Panel(s) not connected properly to Power Optimizer inputs (not applicable to smart modules).</p> <p>Connect the modules to the Power Optimizer inputs.</p>
	<p>PV string reverse polarity.</p> <p>Check PV string polarity using a voltmeter and correct if needed.</p>

Malfunction	Possible Cause and Corrective Action
<p>PV string Voltage is higher than number of Power Optimizers</p> <p>WARNING! If the measured voltage is too high, the installation may not have a safe low voltage. PROCEED WITH CARE! A deviation of $\pm 1\%$ per PV string is reasonable.</p> 	<p>Extra Power Optimizer(s) connected in the PV string (not applicable to smart modules). Check if an extra Power Optimizer is connected in the PV string. If not – proceed to next solution.</p> <p>A module is connected directly to the PV string, without a Power Optimizer (not applicable to smart modules). Verify that only Power Optimizers are connected in the PV string and that no module outputs are connected without a Power Optimizer. If the problem persists, proceed to the next step.</p> <p>Power Optimizer(s) malfunction.</p> <ol style="list-style-type: none"> 1. Disconnect the wires connecting the Power Optimizers in the PV string. 2. Measure the output voltage of each Power Optimizer to locate the Power Optimizer that does not output 1V safety Voltage. If a malfunctioning Power Optimizers located, check its connections, polarity, module, and Voltage. 3. Contact SolarEdge Support. Do not continue before finding the problem and replacing the malfunctioning Power Optimizer. If a malfunction cannot be bypassed or resolved, skip the malfunctioning Power Optimizer, thus connecting a shorter PV string.

Appendix B: Mechanical Specifications

The following figure provides inverter dimensions in mm [in].



Figure 29: SolarEdge Home Hub Inverter - Three Phase: dimensions

Appendix C: SafeDC™

The SolarEdge inverters are certified for compliance with the following standards as disconnection devices for PV generators, meaning that they can replace a DC disconnect:

- IEC 60947-3:1999 + Corrigendum: 1999 + A1:2001 + Corrigendum 1:2001 + A2:2005;
- DIN EN 60947-3
- VDE 0660-107:2006-03
- IEC 60364-7-712:2002-05
- DIN VDE 0100-712:2006-06.

In compliance with these standards, follow the instructions below to disconnect DC power:

1. Move the inverter P/ON/OFF switch to OFF (0) and wait 5 minutes for the capacitors to discharge.
2. Disconnect the AC to the inverter by turning OFF the circuit breakers on the distribution panel.

Support Contact Information

If you have technical problems concerning SolarEdge products, please contact us:



<https://www.solaredge.com/service/support>

Before contact, make sure to have the following information at hand:

- Model and serial number of the product in question.
- The error indicated on the SetApp mobile application, on the monitoring platform, or by the LEDs, if there is such an indication.
- System configuration information, including the type and number of modules connected and the number and length of strings.
- The communication method to the SolarEdge server, if the site is connected.
- The product's software version as it appears in the status screen.

solaredge