



aleo

ELEGANTE

BIPV modules

INSTALLATION MANUAL 1.5

07/2022

Please read this carefully
prior to installation.
Store in a safe place for
maintenance.

→ 1 Table of content

2	Product support	2
3	Explanation of safety guidelines	3
4	About this manual	3
4.1	Detailed information for installers and planners	3
5	About aleo modules	3
5.1	Intended use	3
5.2	Product-specific information	3
6	Installation	4
7	Mounting specifications	7
7.1	Safety glass regulations	7
7.2	Linearly supported modules	7
7.3	Punctually supported modules	7
8	Electrical installation	8
8.1	Personal protection	8
8.2	Electrical Connections	8
8.3	Junction box	9
8.4	Cable couplers for junction boxes	9
8.5	Connectors	9
8.6	Cables	9
8.7	Laying the string cables	9
9	Maintenance	10
9.1	Review	10
9.2	Inspections	10
9.3	Cleaning	11
9.4	Repairs	11
10	Decommissioning	12
10.1	Disposal	12
10.2	PV CYCLE	12

→ 2 Product support

In addition to this installation Manual, aleo solar also provides further information on its website.

→ www.aleo-solar.de

Contact aleo solar GmbH

Marius-Eriksen-Straße 1
17291 Prenzlau
Germany

Tel. +49 (0)3984 8328-0
Fax +49 (0)3984 8328-115
E-Mail info@aleo-solar.com
Web www.aleo-solar.com

© 2022 aleo solar GmbH

This installation Manual is protected by copyright. All rights reserved. Copying, reproduction, translation, or conversion to any type of electronic media or machine readable form, in its entirety or parts, is not permitted. An exception will be made for a backup copy for your own use. aleo solar reserves the right to change this document without prior notice.

aleo® and aleo solar® are registered, protected trademarks of aleo solar GmbH.

Deutsch (de-DE)	Wenn Sie diese Insatallationsanleitung in deutscher Sprache benötigen, wenden Sie sich bitte an aleo solar, siehe Kap. 2.
English (en-GB)	If you require this installation manual in English, please contact aleo solar, see chap. 2.

→ 3 Explanation of safety guidelines

The information on warning and cautions is structured as follows



- The **WARNING** symbol indicates an imminently or potentially dangerous situation which can lead to serious injuries if not avoided.



- **NOTE** indicates a potentially dangerous situation which can cause material damage if not avoided.



- If this symbol also appears on a danger or warning product label, it is warning you of the danger caused by electric current or voltage which can lead to personal injury if you fail to observe the instructions.

→ 4 About this manual

This Edition 1.5 installation manual GG Elegante is released with the edition date 07/2022. Installation manuals related to other aleo products (framed modules) do not lose their validity. aleo solar constantly strives to improve its products and their documentation. Therefore, we advise you to use the latest version of the manual at all times.

Hand over this installation manual to the operator after installation and ensure you have confirmation of receipt.

4.1 Detailed information for installers and planners

4.1.1 Information on the aleo solar website

You can find the latest release of the installation manual and additional information on aleo solar's website

- www.aleo-solar.com

4.1.2 Information sources for operators

If you have any queries about the latest release, contact your aleo solar specialist partner or aleo solar directly (see ch. 2 „Contact“).

→ 5 About aleo modules

5.1 Intended use

aleo modules are suitable for installations near livestock farms and coastal regions.

Observe all the applicable legislation, regulations, guidelines and standards when installing the modules.



- Do not install aleo modules on vehicles and do not use them in air, space or seafaring applications.

- Do not use aleo modules if they are exposed to concentrated sunlight or strong artificial light, or if they could be immersed in water or other liquids or exposed to vapour.

5.2 Product-specific information

Product-specific information (e.g. the data sheet) contains details of a particular type of module.

This module is rated for use in application class A according to IEC 61730. For electrical ratings please refer to the data sheet. Data sheets may change without prior notice. If the information in the data sheet differs from this manual, the data sheet takes precedence.

Under normal conditions, solar modules are likely to experience conditions that produce more current and/or voltage than reported at standard test conditions.

Accordingly, the values of ISC and VOC marked on the modules should be multiplied by a faktor of 1.25 when determining component voltage ratings, conductor ampacities, fuse sizes, and size of controls connected to the PV output.

→ 6 Installation

 → Do not stack packaging units.







 → Leave the modules in the original packaging until installation.

→ Store the modules safe in dry rooms. The packaging is not weatherproof!

→ Store the modules at an ambient temperature of max. 40°C







 → Check the packaging for damage.

→ Follow the packaging instructions.

→ If the packaging is damaged, contact the shipping company.









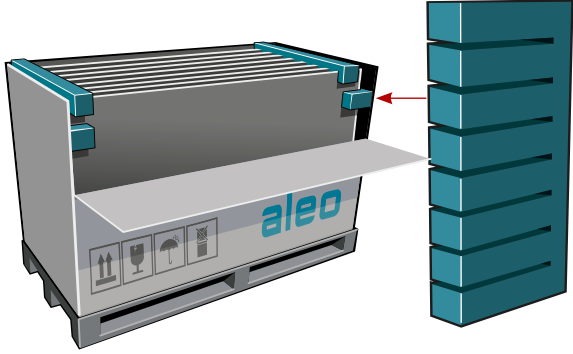

 → Side pads serve as packaging stability

→ Before unwrapping the module remove the side pads at the top



 → NOTE ! Damage to the modules!

→ Open the packaging as shown in the picture

→ Two persons are required to lift the modules!

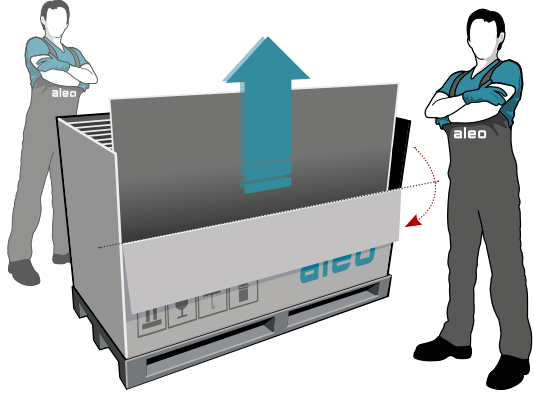

 → NOTE ! Damage to the modules!

→ Do not stack the modules.

→ Leave the modules in the packaging before mounting





! → **WARNING ! Danger due to electric shock!**
→ Only use components which are in perfect condition. Do not install solar modules with visible damages.

! → **NOTE ! Damage to the modules!**
→ store modules in an upright position on wedges with suitable padding. Use adequate padding also between individual modules.

! → Always carry the aleo modules with one other person.

! → **NOTE ! Damage to the modules!**
→ Use glass suction cups to transport the modules.
→ Hold modules on their long sides.

! → **NOTE ! Damage to the modules!**
→ When transporting modules make sure not to put any strain or pressure on the junction box and cables.

! → **WARNING ! Danger due to electric shock!**
→ Block off the danger zone for people or animals before beginning the installation.

! → Protect yourself from burning by wearing gloves and suitable clothing.
→ Only use approved, insulated tools for installation or maintenance work on live parts.



! → NOTE ! Damage to the modules!
→ Changes may be made to the module only in case they have been approved by aleo in writing.



! → Work in dry conditions.

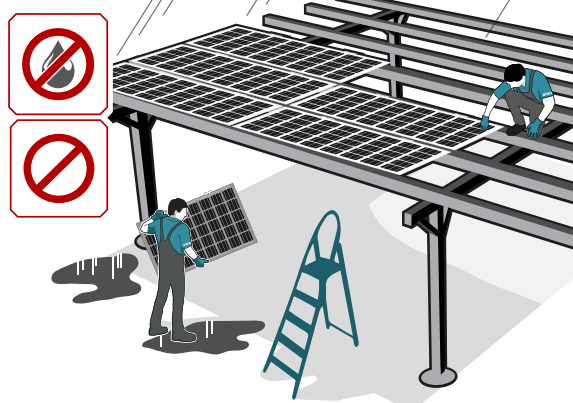

! → NOTE ! Damage to the modules!
→ Risk of modules falling or colliding with other objects!



! → NOTE ! Damage to the modules!
→ Never step on the modules!
→ Do not apply mechanical stress to the modules.
→ Do not drop any objects on the modules.

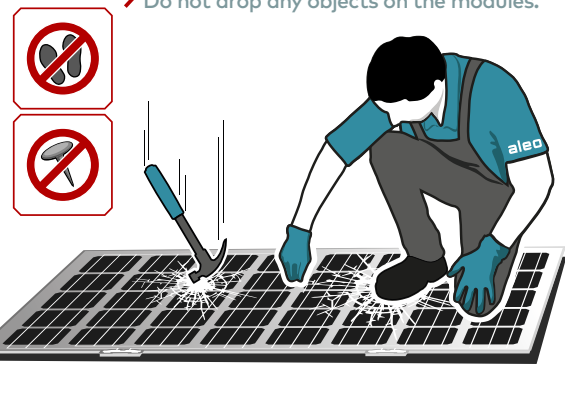

! → Beware of sharp glass edges or flying glass splinters, be especially careful with glass edges.

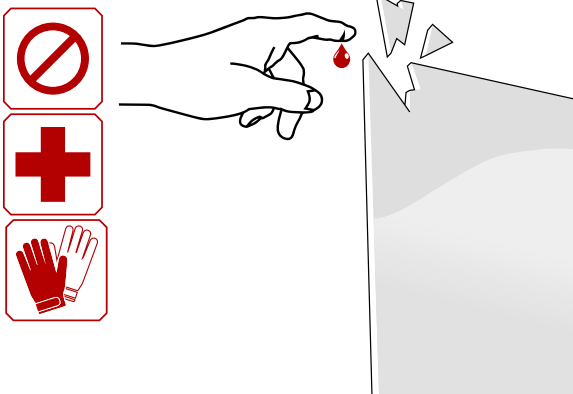

→ 7 Mounting specifications



NOTE

- Always ensure that the mounting structure is earthed ($R \leq 10\Omega$).
- Leave a minimum distance of 5mm between modules when mounting. This prevents mechanical tension due to thermal expansion of the glass.
- Leave a distance of at least 4cm between the back side of the modules and the underlying surface, to ensure the rear ventilation of the module.

7.1 Safety glass regulations

The product Elegante is a photovoltaic composite safety glass (PV-VSG), marked with the code Z-70.3-258 for the general architectural license (in Germany "allgemeine bauaufsichtliche Zulassung - abZ"). The module is a laminated safety glass (VSG) and should therefore be used as a construction product.

In case of uncertainty regarding the mounting and for each topic not contained in this manual, please contact us.

7.2 Linearly supported modules

Most of the architectural applications foreseen for this product, e.g. carports or verandas, take reference to mounting types in which the modules are supported on at least two opposite sides through a continuous line. Depending on their inclination against the perpendicular, they are divided into overhead glazing (inclination $> 10^\circ$) or vertical glazing (inclination $\leq 10^\circ$).

→ Figure 7A

Elegante Modules are licensed for both kinds of installation.

Mounting depth:

In case of an all-round linear support (e.g. in a frame) the mounting depth must be at least 10mm. In the case of two or three-sided linear support, the mounting depth must be at least 15mm.

Deflection:

The assembly must be carried out in such a way that the deflection of the module is not more than 1/100.

→ Figure 7B

Since the wind can equally act as a pressure or soak

load, the linear support must ensure that the glass safely remains in the support for both types of load. No contact between glass and hard materials (e.g. metal, wood) may occur under load and temperature effects.

For distance between supports higher than 1.20 m there is an increased risk that the glass will leave the bearing in the event of a break.

Therefore, modules with a linear support along the short side of the Elegante module, where the span is higher than 1.20m, must be placed on all sides in a linear support.

Drilling and cut-outs in the modules are not permitted.

The free edge of the module, parallel and perpendicular to the bearing, can be at most 30% of the support length, but in any case not more than 300mm.

Overhead glazing:

In case of overhead glazing we recommend that the surface of the modules is inclined at an angle of at least 5° , so that precipitation can drain off supporting the modules self-cleaning.



NOTE

- Elegante Modules linearly supported on the long sides, can bear pressure loads till 7500 Pa and soak loads till 5400 Pa, according to IEC 61215 (Crystalline silicon terrestrial photovoltaic (PV) modules – Design qualification and type approval), without compromising the functional capability of the PV module.

7.3 Punctually supported modules

The technical rules for the dimensioning and execution of point-mounted fastening types apply:

The point holders must be made of stainless steel with at least a corrosion resistance class II.

The assembly must be designed in such a way that the modules can be installed with consideration of structural tolerances and that the glass cannot come in contact with other hard components (e.g. metal) under operating conditions (load, temperature, inflection of load bearing construction).

The free edge of the glass must not be more than 300 mm and at least 80mm.

→ Figure 7C



NOTE

- The required minimum mounting depth of a clamp is 15mm.
- Elegante Modules punctually supported with clamps on the long sides, mounted according to the rules, can bear pressure and soak loads till 5400Pa, according to IEC 61215 (Crystalline silicon terrestrial photovoltaic (PV) modules – Design qualification and type approval), without compromise the functional capability of the PV module.

→ 8 Electrical installation

8.1 Personal protection



WARNING!

High DC voltages during storage, installation, operation and maintenance. Risk of fatal electric shock!

- aleo modules may only be installed by qualified technicians with a high level of expertise (see sample of connection → Figure 8A).
- Never touch the electrical connections of a solar module under any circumstances, not even if you have disconnected the photovoltaic generator.



WARNING

Electric arcs are generated when electrical components are connected or disconnected incorrectly.

- Before you carry out any work on electrical components, disconnect the photovoltaic generator.
→ Figure 8B



WARNING

Contact with live parts due to defective insulation or damaged / fallen off junction box covers.

- Figure 8C
- Do not touch damaged parts with your bare hands.
- Use protective clothing and suitable, insulated tools.

→ 7A

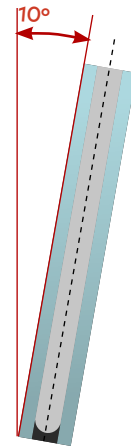

→ 7B

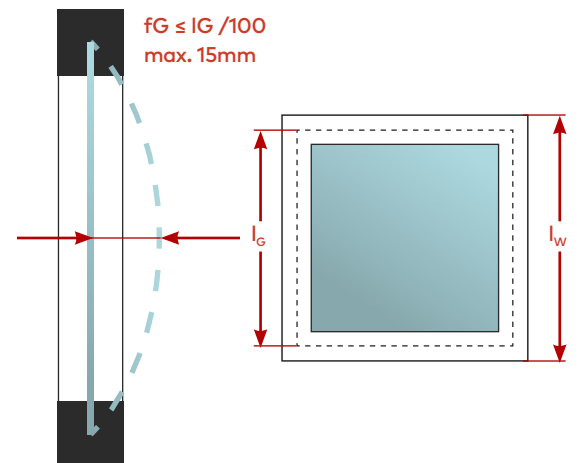

→ 7C

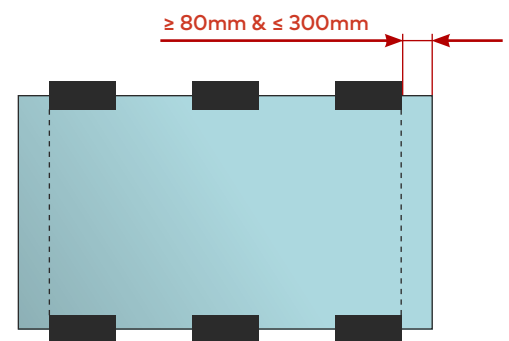

8.2 Electrical Connections

For modules connected in series, only modules of the same amperage rating may be used together. For modules connected in parallel, modules with the same voltage ranges must be used together. The modules must not be operated at a higher voltage than the permissible system voltage.

8.3 Junction box

- Avoid standing water in the junction box area.

When mounting horizontally, make sure that the junction boxes are facing upwards.

- The junction boxes and the surrounding area (at least 15 mm from the glass edge inwards and at least 25 mm to the left and right of the junction box) must be protected against direct sunlight, precipitation and dirt.

The use of an aluminum clamping rail is recommended for this purpose.

8.4 Cable couplers for junction boxes



NOTE

Only use cable couplers that are the same type and compatible to the specific junction box.

Insert the cable couplers in the junction boxes only through the outer slots on the left and on the right of the module, as shown in the picture.

- Figure 8D

8.5 Connectors



WARNING

- Incompatible or unsuitable connectors can overheat. Fire hazard!

Only use connectors that are the same type and compatible to the specific inverter.

This module type can be fitted with the following connectors:

- TE - SOLARLOK Slim Line (Plus:1-1987559-1; Minus: 1-1987559-2)

You can remove the connector on a module and replace it with another connector, if necessary. You retain

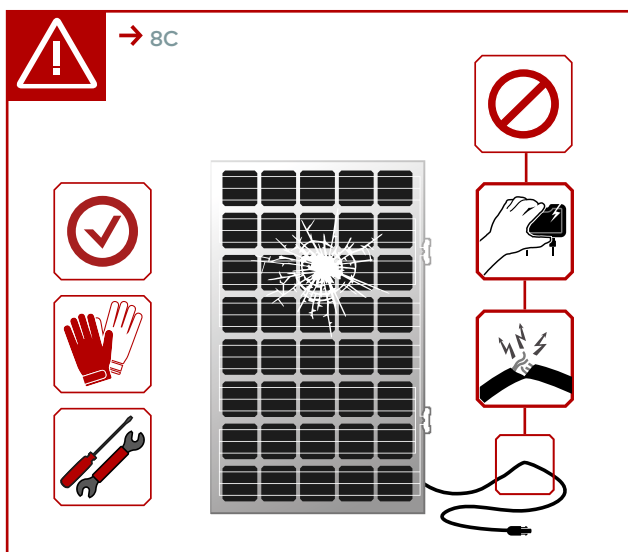
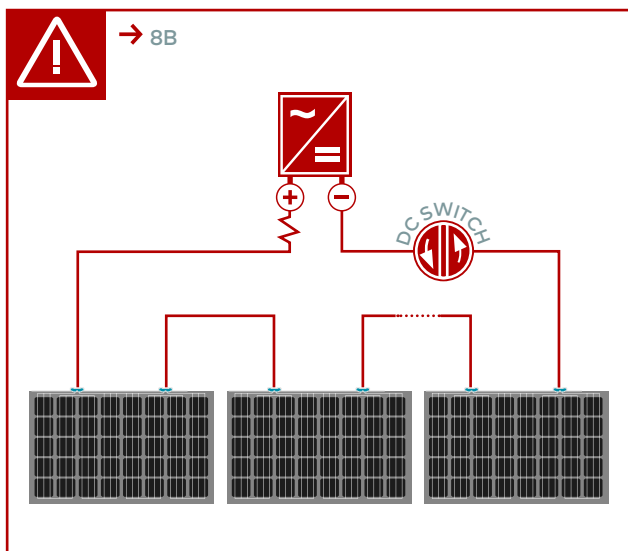
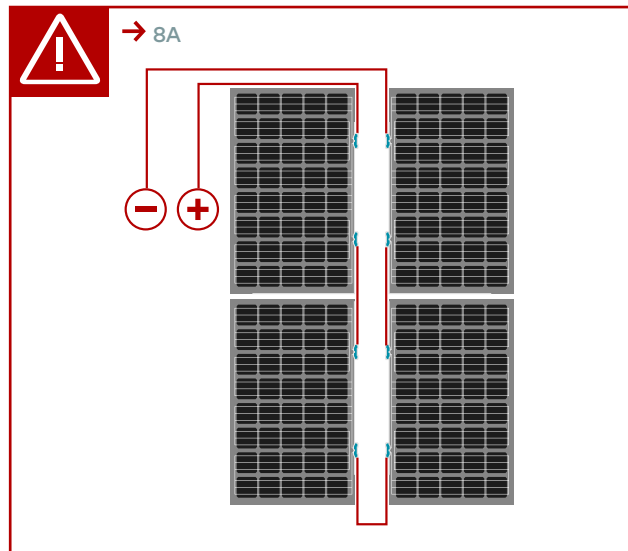

the manufacturing warranty if you remove and mount with approved tools in the proper way and according to the connector manufacturer's instructions.

8.6 Cables

Only solar cables with an 4mm² cross-section and appropriate connectors may be used for connecting the modules.

8.7 Laying the string cables

Pay attention to bend the cables after they exit from the connector, in order to keep them waterproof at the cable outlet.

→ Figure 8E

This keeps the cables waterproof at the cable outlet.

→ **Protect cables from direct sunlight, precipitation and dirt.**

→ Figure 8F

Cables from module strings are laid as near to each other as possible to minimise the effects of being struck by lightning.

→ 9 Maintenance



NOTE

→ Inspect and maintain your system to:

- keep it safe and reliable
- achieve top output
- prevent damages
- protect your investment

9.1 Review

aleo solar recommends carrying out a thorough review at least every 4 years. This includes the following work in addition to the inspection:

→ RECOMMENDATION

aleo solar explicitly recommends annual inspections and a more thorough inspection and measurement every 4 years.

We also recommend the use of a monitoring system to identify any outages or problems quickly. Inspecting the output of your photovoltaic system regularly can help to discover problems promptly, and ensures your photovoltaic system operates at top performance, preventing loss of output.

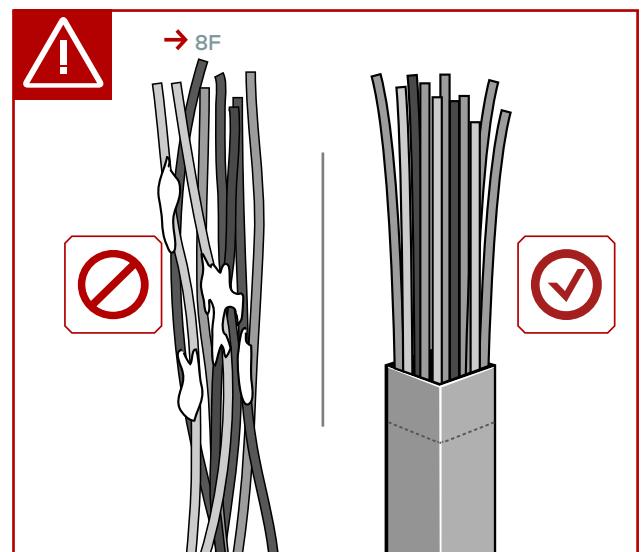
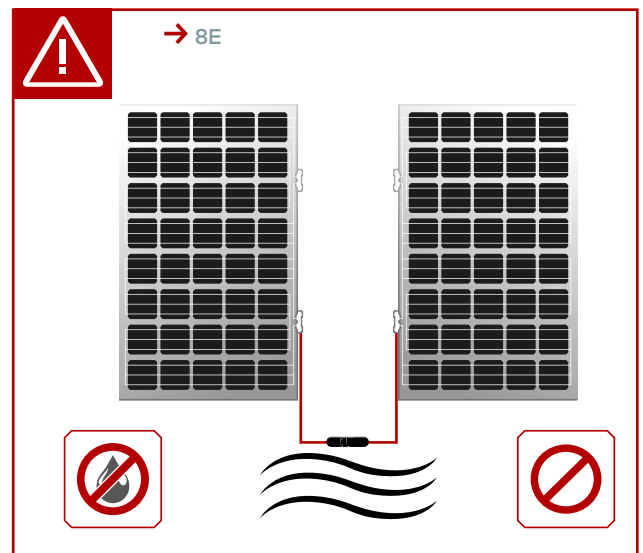
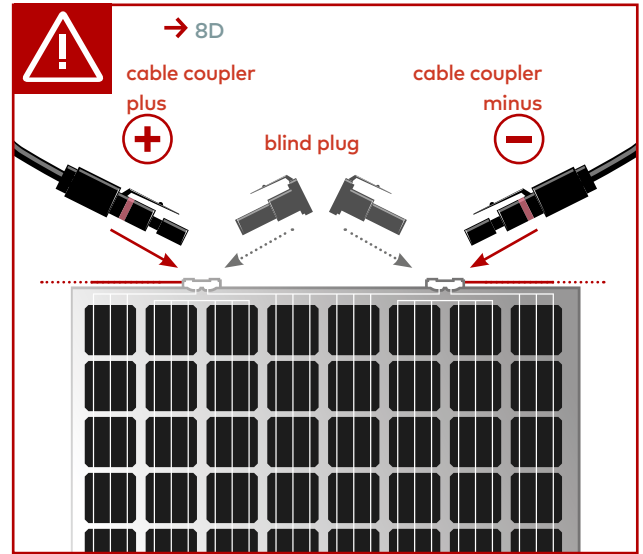

For the proper maintenance and repair of your aleo solar photovoltaic system, contact your aleo solar dealer or get in touch with aleo solar directly (see Ch. 2.2: „Contact“).

9.2 Inspections

aleo solar recommends an inspection every year. The inspection includes the following aspects.

9.2.1 Inspecting the generator

- strings: condition of the insulation and mounting
- condition of the junction box
- condition of the visible connectors
- condition of the mounting system
- dirt on modules: type and degree of dirt
- shade circumstances (e.g. from trees or neighbouring houses)

9.3 Cleaning

Depending on the ambient conditions, modules are likely to get soiled more or less heavily over time. This can cause reduced output.

Dirt could be:

- dust, pollen or seed
- leaves or twigs
- deposits from stable vapour
- moss, algae, fungi or bacteria growing on
- deposits (in short: biofilms)
- salt (in coastal regions)

9.3.1 Safety precautions



WARNING

- Contact of live parts with water.

Risk of electric shock!

Never use a high pressure cleaner.



NOTE

- You will also retain the manufacturer's warranty as a result of this measure.

9.3.2 Glass surfaces



NOTE

- The glass surfaces of aleo modules have microscopic structures or anti-reflex coatings. Ensure that these do not get damaged. Do not use any cleaning agents which will polish or scratch the surface.
- Avoid the use of very hard water.
- Also avoid the use of distilled or demineralized water if possible.
- Avoid the use of acids, bases or other aggressive cleaning agents.



NOTE

Dirt- or water-repellent coatings subsequently applied to the modules can negatively affect the efficiency of the aleo modules and therefore the power output of the whole photovoltaic system. We therefore advise against the use of these agents.

→ RECOMMENDATION

For cleaning the glass module surfaces,

aleo solar recommends:

- rainwater without additives with its temperature matching the temperature of the module
- a soft sponge or a soft brush
- If necessary, use a telescopic rod with a sponge or soft brush attached on the end. The rod can have a water pipe integrated.

For stubborn patches of dirt, use the following to help:

Isopropanol: aleo solar recommends a mixture of isopropanol and rainwater to the ratio of 1:1

Glass cleaner: As an alternative, aleo solar recommends clear, colourless glass cleaner with no ethanol or denaturants (e.g. Bitrex®).

→ Anti-reflex glass

aleo modules have an anti-reflex layer on the glass surface to achieve a higher output. This means that some marks (e.g. fingerprints) are more visible than on normal glass. These marks are mostly seen as shimmering patches.

These kinds of marks do not have any

measurable effect on the module output and fade away after about 2 weeks of being exposed to weather conditions, as sunlight and rain break them down.

9.3.3 More frequent cleaning

→ RECOMMENDATION

In environments subject to heavy soiling, we recommend making the intervals for inspections and cleaning shorter than just once a year.

aleo solar recommends contracting a specialised company to clean your photovoltaic generator properly without treading on the modules, if frequent cleaning is necessary.

9.4 Repairs

9.4.1 Modules

A defective module can cause loss of output, as well as consequential damage. If an aleo module needs repairing, first get in touch with aleo solar (see Ch. 2: „Contact“).

Never, under any circumstances, repair an aleo module yourself: only contract technicians who have been authorized by aleo solar to avoid loss of warranty.

Before you carry out any maintenance work on aleo modules, deactivate the module string or the whole generator if necessary. Observe the warnings and notes in Ch. 6.2.2.

9.4.2 System parts

For repairing other system parts (e.g. substructure, connection boxes), contract authorized technicians to do the work or contact aleo solar directly

(see Ch. 2: „Contact“).

→ 10 Decommissioning

10.1 Disposal

→ Dispose of the aleo modules at the end of their service life contacting a disposal company.

→ Never dispose of aleo modules with household waste.

10.2 PV CYCLE

aleo solar is member of PV CYCLE. Used or damaged PV modules from aleo solar are disposed of by PV CYCLE without any costs. Under certain circumstances transport costs may apply in the context of disposal.

PV CYCLE offers a comprehensive collection network for PV module waste, from fixed collection points to on-site pick-up.

Please contact operations@pvcycle.org for your individual disposal solution.

Notes



www.aleo-solar.com