

# Installation Manual

## BISOL PV MODULES

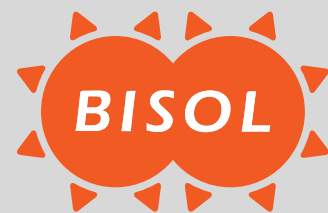

Solar company!

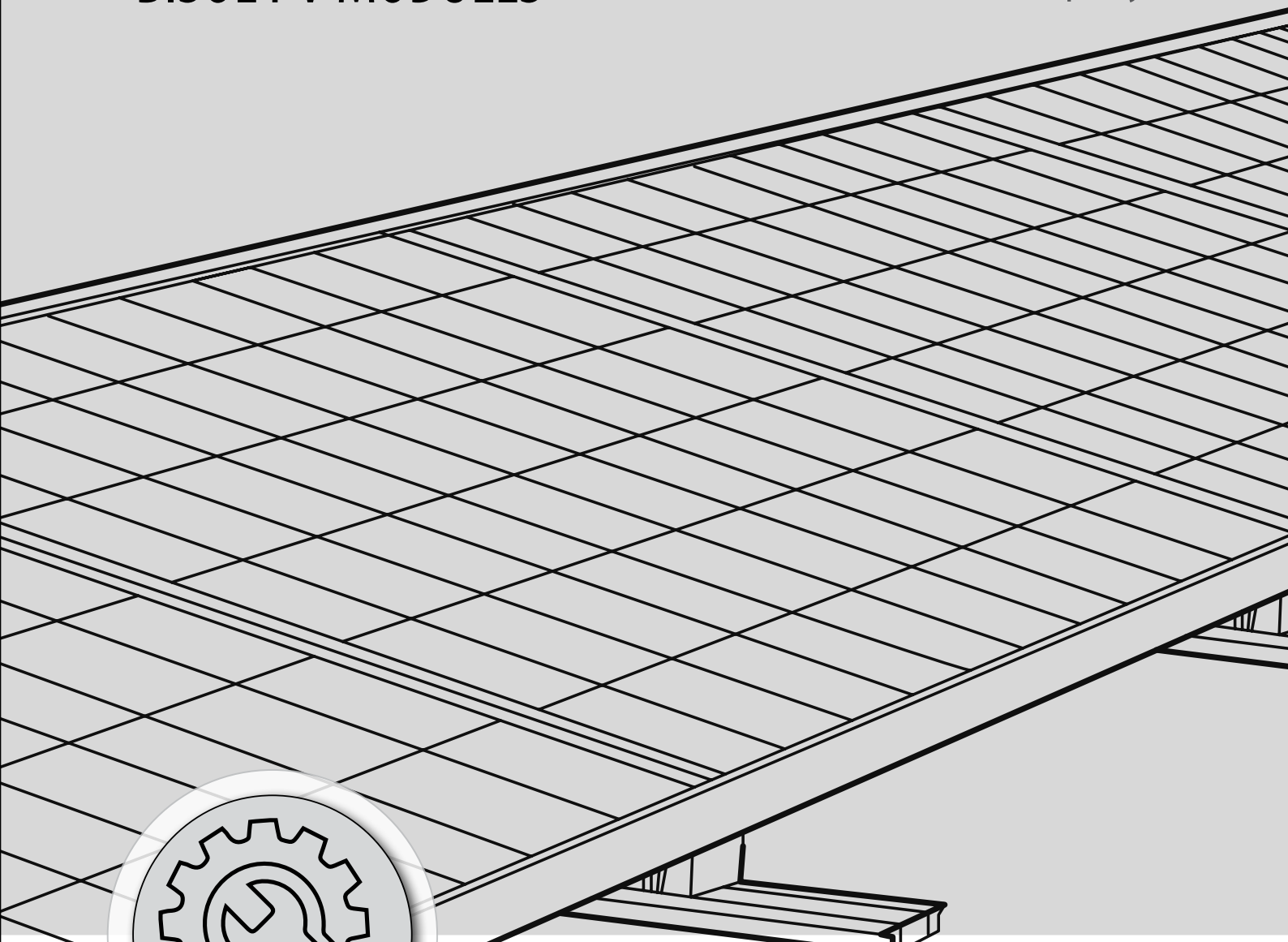

The **sunny** side of life!



# THANK YOU!

We want to congratulate you for purchasing BISOL solar modules and express our most sincere gratitude for using products that are high energy efficient and designed for long-term high-performance use. It is our pleasure and delight to know that we have been able to fulfil your expectations with our high-quality materials processed on state-of-the-art automated production line.

We are proud of our products, and we are proud of you as our BISOL ambassador.

BISOL Team



Before starting the installation of BISOL solar modules, carefully read this entire installation manual. *This manual* contains important information about safety, installation, wiring, operating, maintenance and similar.

If any further information is necessary, please consult your module dealer or the manufacturer directly. Failure to follow these instructions may result in material damage and can in worst case jeopardize life safety and health.

Store this manual in an easy reachable place.



# TABLE OF CONTENTS

- WARNINGS.....4**
- TRANSPORTATION, PACKING REMOVAL AND TEMPORARY STORAGE.....5**
- MODULE INSTALLATION.....5**
- SUITABLE LOCATION.....7**
- SUITABLE ENVIRONMENTAL CONDITIONS.....7**
- MOUNTING.....8**
  - Mounting with clamps.....8
  - Insertion system .....8
- WIRING.....9**
- GROUNDING.....11**
- MAINTENANCE AND CLEANING.....12**
- DISPOSAL.....13**
- BISOL LAMINATE.....14**
- DISCLAIMER OF LIABILITY.....15**
- ATTACHMENT GUIDELINES.....16**
  - 60 cells PV MODULES .....16
  - 72 cells PV MODULES .....17
  - 120 cells PV MODULES .....18
  - 144 cells PV MODULES .....19

## WARNINGS

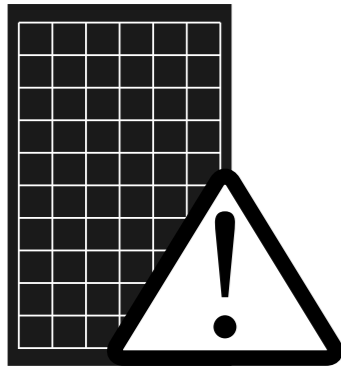

- Photovoltaic (PV) modules produce direct current when exposed to light. Even when disconnected, voltage can be present on module terminals.
- Contact with active electrical parts can cause fire, sparks or even deadly electrical shock.
- Single module can produce only low voltage level, but when connected in series, the voltage increases.
- Perform all the work with extreme caution and use safe equipment only (such as appropriately isolated tools).
- Do not mount and install the modules under inappropriate weather conditions like strong thrusts of wind, storms and similar.
- Installation tools and electrical connectors have to be dry. Do not connect PV modules with moist connectors.
- Take care that electrical contacts are faultless (connectors have to be completely clean and fully inserted).
- Do not open the junction box on the back side of the module.
- Never disconnect a module when it is under load. Remove the load first.
- Deadly electrical arc can appear when disconnecting connectors under load.
- Do not use modules that are damaged (e. g. a module with broken glass).
- Do not pull junction box cables and take precaution when handling with the PV module.
- Do not use the junction box for transportation help or for holding the module.
- Use only equipment, connectors, wiring and supporting constructions designed for use in photovoltaic systems.
- Be sure that module properties are suitable for conditions at the place of installation. They are always suitable for ground and rooftop installations, but even though their use is not limited, they are usually not intended for camper or boat installations.
- Do not treat the back side of the module with paint, glue or sharp objects.
- Do not try to disassemble the module, for example removing frames, cables or junction box.
- Do not drop the module.
- Do not drop anything on the module.
- Do not step on the module.
- Do not bend the module.
- Do not wear metallic jewellery while you are performing installation of PV modules.
- Follow all safety measures for other components that are used in the system.
- When installing PV modules, please follow local legislation.



When connecting large number of modules, there is a danger of deadly electrical shock!

## TRANSPORTATION, PACKING REMOVAL AND TEMPORARY STORAGE



- When transporting, storing and handling the modules, take care not to damage the modules, yourself or others.
- Modules must be stored in dry and ventilated spaces (electrical contacts must be clean and dry, no standing water, snow or ice is allowed).
- We recommend that modules stay packed in their original packing until you are ready to install them. Please follow stacking limit.
- When handling the modules, take in account all the warnings.
- Carry the modules using both hands.
- Do not put weight on the modules and only stack modules in their original packaging.
- Do not remove any identification labels from the modules. It will result in void guarantee.
- Writing down and storing serial numbers of the modules for the future use is recommended.

## MODULE INSTALLATION

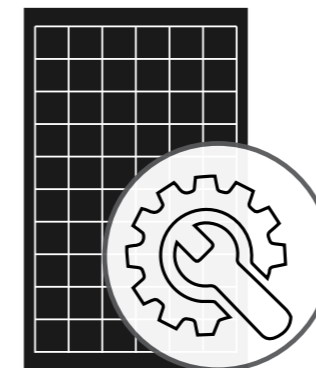

While installing the modules, you must unconditionally follow:

- general rules for safety at work,
- rules for electrical installation and devices,
- construction rules and
- all other regional and national rules and regulations.

For roof mounting, it is necessary to follow all the technical and working regulations in the roofing industry. Acquire all the needed permits before starting the installation.

### When installing the modules, you must consider the following:

- Before installing, we recommend covering the modules with an opaque cover to prevent the electricity being generated.
- Only appropriately qualified and trained personnel can perform the installation of PV devices and modules.
- When working on high places, appropriate safety measures must be taken.
- Only the area electrician with distributor's permission can connect the photovoltaic system to the public grid.
- Do not drill any holes into the frame or glass of the module. If you do, the guarantee will be void.
- Do not expose the modules to concentrated light (use of lenses or similar).
- Do not use different types of modules in the same system. When connecting the modules in series, use only modules that have the same current properties. When connecting the modules in parallel, only use modules that have the same voltage properties.
- Connect together only the number of modules that is suitable for the connecting device (inverter, load balancer).
- Make sure that the module is suitable for use in the photovoltaic system.
- Maximum open circuit voltage of the system must never be higher than the maximum system voltage of the module with respecting safety factor.
- When connecting the cables and terminals, make sure the polarity is correct.
- You should avoid any possibility of electrical shock when installing, wiring, operating and mounting the modules.
- PV modules belong to the Safety Class II, for which grounding is not requested, but it is highly recommended. Grounding the frames of the modules and construction where the modules are fixed as well as protecting them from lightning strikes is recommended. Equipotential bonding is requested.
- For wiring use only cables with cross-section and connectors suitable for the short-circuit current of the modules.
- Cables should be as short as possible to reduce voltage drop and maintain high system performance.
- When connecting several modules together, fix the wiring to the carrying structure. To prevent swinging of the wiring, we recommend the use of suitable fixing clips.
- In the areas where children or animals are present, the wiring should be extra protected.
- Do not install the wiring over sharp edges.
- Make sure the carrying structure can handle extra wind and snow loads.
- Components used in the system must not have any harmful electrical or mechanical effect on the modules.
- Modules must not be mounted as a roof glazing.
- Modules must be installed in a way that the stagnant water will never be present on them.
- Modules must not be installed near waterfalls, sources of harmful chemicals, sea, strong EM field (for example close to a high voltage power line).
- Attention must be paid to all local, regional, national and international directives and appropriate standards.
- When installing PV modules, the following is requested:
  - fire resistant roof,
  - ventilation gap (to allow adequate airing),
  - spacing gap (to compensate or thermal expansion).

## SUITABLE LOCATION

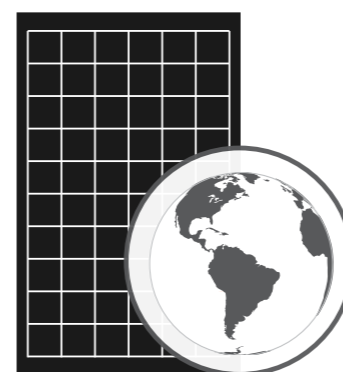

In order to get the highest energy yield, the best suitable location for placing the modules should be found. In the northern hemisphere, tilt the modules in the southern direction, and in the southern hemisphere, tilt them to the north. For the optimal tilt angle of the module consult your local supplier of the photovoltaic equipment.

When mounting the modules, extra attention should be paid that the modules are not shadowed or even partially shadowed (by poles, chimneys, trees and similar), because shadowing negatively affects the whole system. Even the smallest partial shadowing, like dust, decreases energy yield.

The use of the modules in special climates, such as altitudes greater than 2000 m, heavy snow, hurricanes, severe hail storm, etc. should be consulted with BISOL's technical support department.



### Did you know?

Shadow free module is a module that is never shadowed during the whole year and is able to receive sunlight between 9:00 and 15:00 even during the shortest day of the year.

## SUITABLE ENVIRONMENTAL CONDITIONS



- Modules are designed to be used in a typical climatic condition and should not be installed in areas where danger of explosion exists.
- Modules may not be installed near areas with flammable gasses and steams (e. g. petrol station, gas reservoirs).
- Modules may not be installed near open flames and flammable materials.
- Modules fulfil the EN 13501-5 standard and received the classification B<sub>ROOF</sub> (t1).
- Modules may not be installed in toxic atmosphere (near sea, volcano, industry emitting toxic gases).

- Modules are not intended for car, boat or other moving installations.
- The modules must not have stagnant water present on them.
- Modules are intended for use in general open-air climates as defined in IEC 60721-2-1 under *Classification of environmental conditions Part 2-1: Environmental conditions appearing in nature. Temperature and humidity*. It is recommended to install the modules in an environment with a temperature range from -40 °C to +40 °C. Module operating temperature must be lower than 85 °C.

## MOUNTING

You can fix the modules on different structures. Supporting structure must be made of durable material that is non-corrosive and UV-light resistant. The modules should be attached to the mounting structure in a way to ensure sufficient ventilation of the modules. Modules should be firmly fixed in place in a manner suitable to withstand all expected loads in accordance with the local regulations.

### ! Check also

The maximum allowed loads based on different attaching points can be found in BISOL Module Attachment Guidelines on page 15.

### Mounting with clamps

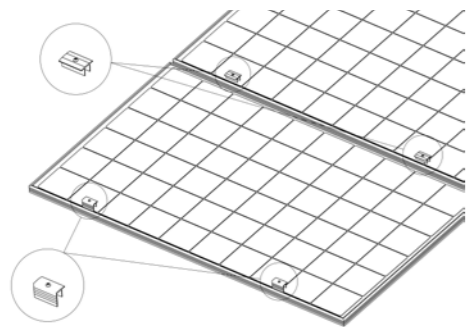

Clamping system

The modules should be mounted basically at the 4 or 6 symmetrical points according to the module attachment guidelines. Metals used in locations that are exposed to moisture shall not be employed alone or in combinations that could result in deterioration or corrosion. The maximum torque of the clamps should be applied according to the clamping system design request. Please be alert that overtightening might cause module damage. All screw connections must be either screwed or controlled with a torque wrench – in accordance with the manufacturer's instructions.

The clamping system must provide a secure attachment for the prescribed loads. Trained professional personnel are responsible for the design,

installation and calculation of the mechanical loads and for safety of the clamping system.

Before installing the module, it is necessary to: 1) Check whether the module is damaged, as well as remove dust and dirt caused by transportation. 2) Check that the labels and serial numbers of the module match.

The prescribed mounting material must be used during installation; the use of other material is not allowed unless it has been certified together with the module according to UL2703.

### Insertion system

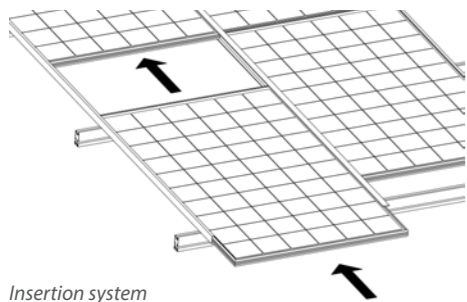

Insertion system

The module may be mounted on the support by using an appropriate insertion system with or without additional clamps. The insertion system may fasten the long or the short side of the module frame.

## WIRING

PV modules produce direct current when exposed to light, while voltage is always present on the module.

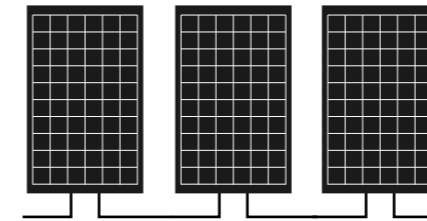

Serial connection

Single module can produce only low-level voltage. When several modules are connected in series, the voltage increases. Summation of voltage takes effect.

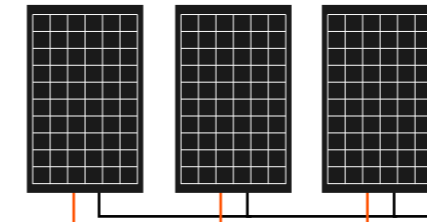

Parallel connection

When modules are connected together in parallel, summation of current takes effect.

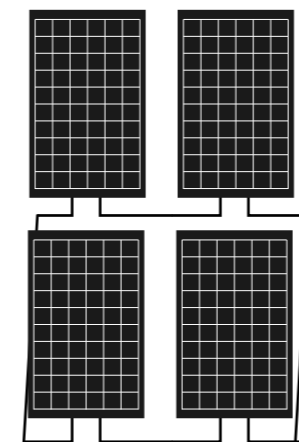

Combined (parallel and serial) connection

When parallel and serial connection combine, summation of current and voltage takes effects.





### When wiring the modules, consider the following:

- Modules are designed for application according to the PV module characteristic label.
- When over-current protection is applicable, the protection must be specific to the declaration values.
- In case of parallel connection, respect the over-current protection instructions from this manual.
- Use cable extensions and connectors suitable for outdoor use only.
- Make sure the electrical cables and connectors are electrically and mechanically fault free.
- Do not loop electrical connections (decrease the risk of indirect lightning strike).
- Use only wiring with suitable conductor cross-section (when calculating the smallest cross-section needed, multiply  $I_{sc}$  and  $U_{oc}$  values with safety factor of 1.25).
- Make sure the connectors are fully connected.
- Protect freely lying connectors with suitable measures (e. g.. protective enclosure).
- Fix the cables with UV resistant materials only.
- Before connecting the system, verify the correctness of connections. If the measured values of open circuit voltage and short circuit current are deviating from expected values, you probably have a bad (wrong) connection.



**!** The electrical specifications are on the label of the module, which can be found on the back side of the module.



## GROUNDING

The frame of the PV module, as well as any exposed metal parts, which are a part of the PV system, must be grounded and connected to the equipment grounding conductor in order to prevent electrical shock.

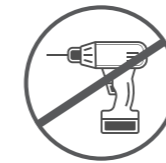

BISOL photovoltaic PV modules have a clearly marked grounding hole on each side of the frame for connection the grounding conductor.

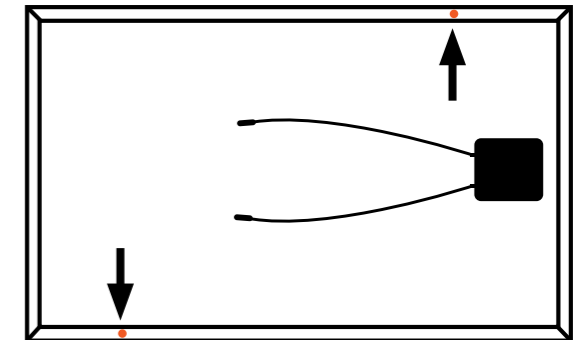

The grounding wire must be properly fastened to the module frame to assure good electrical contacts. Make sure the grounding screw penetrates the anodized surface of the module frame around the holes, and sample control it. For this purpose, a suitable knurled washer must be used – see drawing. The frame is fully insulated by the anodization process, so this step is essential for proper ground contact.

The minimum cross-section of the ground copper wire is 6 mm<sup>2</sup>. All grounding hardware (nuts, bolts, washers, screws, etc.) must be made of stainless steel to prevent corrosion. Grounding of the PV module scan also be carried out with special earthing clips which connecting metal structure and PV module.

**!** **Important:** The star washer of the grounding screw enables module grounding and preventing corrosion due to various metals – galvanic cell. The recommended tightening torque is 2.3 to 2.8 Nm.

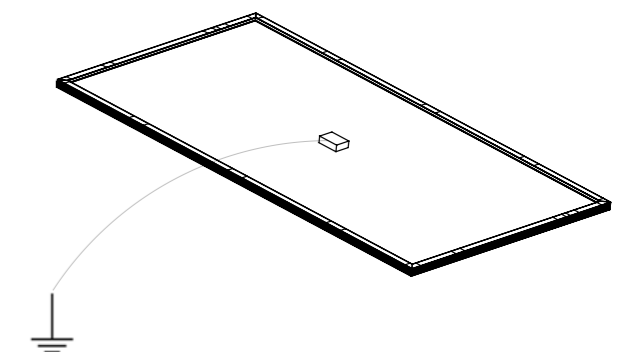
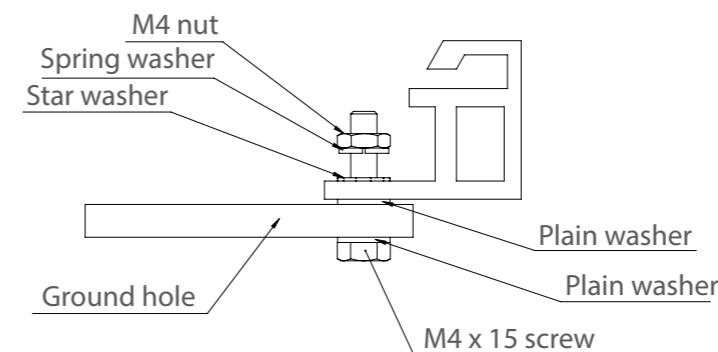

## MAINTENANCE AND CLEANING

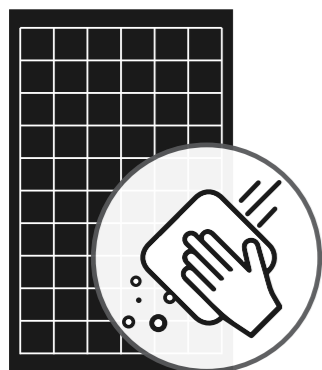

It is recommended that installation, changing and maintenance of the modules is implemented by an authorised service technician. Regular maintenance and cleaning of the modules is highly recommended for them to function well and properly. At regular visual inspection carefully check the condition of glass and frames, possible corrosion, the presence of moisture under the glass, overheating or colour changes at ribbon joints, condition of connectors and electrical cables.

### Changes in the environment

Monitor all changes in the environment, such as new shadow sources (for example planting trees, construction of tall buildings or structures). Carry out regular inspections of the roof and roof elements, as flying parts (roof tiles, vents, gutters, skylights, chimneys, borders etc.) can damage the modules during a storm. Do not step on the modules or remove, repair or change the components by yourself. Do not place any objects on the modules. It is recommended to execute regular preventive inspections of the solar power plant by qualified contractors and to adequately insure the power plant.

### Dirt on the modules

Dirt on the modules can significantly affect the production of electricity, so careful handling and inspection of the modules are recommended. In principle, power plants with more than 10° inclination of modules have a self-cleaning effect with the help of rainwater and cleaning is not necessary or we can clean occasionally. If the inclination angle of the module is less than 10°, the modules must be cleaned more often. It is recommended that the cleaning is done by qualified contractors.

### Smart tip

You can do the dirt level test yourself. It is best to wipe the surface of the module with a cotton cloth after rain. If the cloth is dirty, it is recommended to clean the surface of the module. Most dirt usually accumulates at the bottom edge of the module. It is best to use demineralized water and soft sponges or cloths for cleaning. For more stubborn dirt, you can also use mild cleaners, pure ethanol or glass cleaning detergents. Do not use aggressive (abrasive) cleaning agents that contain acid, ammonia, alkaloids or bleach. Do not clean dry or rub, as this may damage the surface of the module.

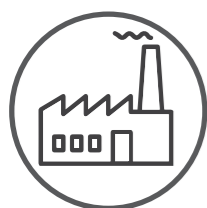

### Did you know?

The level of dirt is mainly influenced by external factors such as industrial area, roads, railways, vegetation (flowering), chimneys and vents (smoke and other emissions), agricultural activity, separation, recycling, waste incineration and collection, amount and intensity of precipitation.

## DISPOSAL



### Information to users under Directive of the European Parliament and Council on waste electrical and electronic equipment (WEEE) (recast)

BISOL promotes and supports responsible and sustainable behaviour and encourages the disposal of waste electrical and electronic equipment (WEEE) at the end of its life in compliance with local regulations.

The crossed bin symbol on the equipment or its packaging indicates that the product must be collected separately from other waste at the end of its useful life and not with mixed urban waste.

Please contact your municipality or local authority for all information regarding the waste sorting systems available in the area. The retailer is obliged to collect the old equipment free-of-charge when the customer buys a new equivalent equipment. This is to encourage correct recycling/disposal.

Appropriate waste sorting for the subsequent recycling, treatment and disposal in an environmentally sound way of the disused equipment avoids negative effects on the environment or human health and favours the re-use or recycling of the equipment's materials.



## BISOL LAMINATE

**BISOL Laminate is a special product which as such is not classified as a PV module, so the PV Module Installation Manual does not apply to it.**

BISOL Laminate is a solar product without a supporting frame and as such is not intended for installation and use without a suitable frame or mounting structure. In order to achieve the appropriate load-bearing capacity of the BISOL Laminate product according to the desired method of installation, it is mandatory to professionally design a suitable load-bearing structure or frame. Contact your responsible designer for further instructions and support. Testing and certification of the selected frame or substructure solution and related guarantees are available with additional charges.

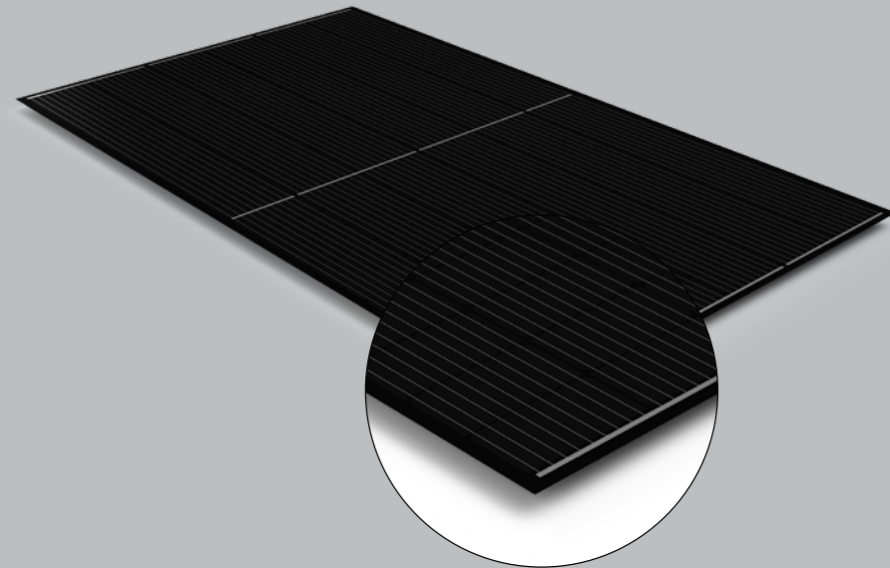

### EXCLUSION OF LIABILITY AT USING BISOL LAMINATE

BISOL Production Ltd. as the manufacturer of BISOL Laminate products in connection with their installation takes no responsibility for the design solutions of individual designers. Due to specifics of their installation, which always depend on the judgment of the individual contractor, BISOL Production Ltd. also takes no responsibility for in connection with the installation of these products, as well as for the choice of mounting structure in this regard.



## DISCLAIMER OF LIABILITY

BISOL Production Ltd. as manufacturer of BISOL PV modules in connection with their installation takes no responsibility for the design solutions of individual designers, also assumes no responsibility in connection with the installation of BISOL PV modules by a third party and contrary to these instructions, as well as for the choice of mounting structure in this regard.

In order for guarantee to be valid, all guarantee pending PV modules have to be free of defects caused by the user, while the use of the PV modules itself has to be performed according to measures of this document and corresponding sub-documents.

By installing BISOL PV modules, BISOL Production Ltd. accepts no liabilities, if instructions in this manual are not followed. Since understanding of these instructions, conditions, installing methods, connections, use and maintenance of PV modules is not controlled or inspected by BISOL Production Ltd., the latter accepts no responsibilities for damage that could arise from failure to implement predicted preventive measures, installation deficits, incorrect connection, usage or maintenance.

Liability for infringements of patent law or of other third-party rights arising from the use of the PV modules is excluded.

By using this installation manual, it is necessary to reasonably use all technical parameters of the products stated on the products itself, as well as all other technical parameters of complete technical documentation.

In addition, BISOL's General Sales Terms & Conditions for Supply of Goods and Services (GSTC) as well as Standard Limited Guarantee terms and conditions for photovoltaic modules apply, both published on BISOL's official website [www.bisol.com](http://www.bisol.com).



# ATTACHMENT GUIDELINES

## 60-cell PV MODULES (cell dimension M0/M2 and G1)

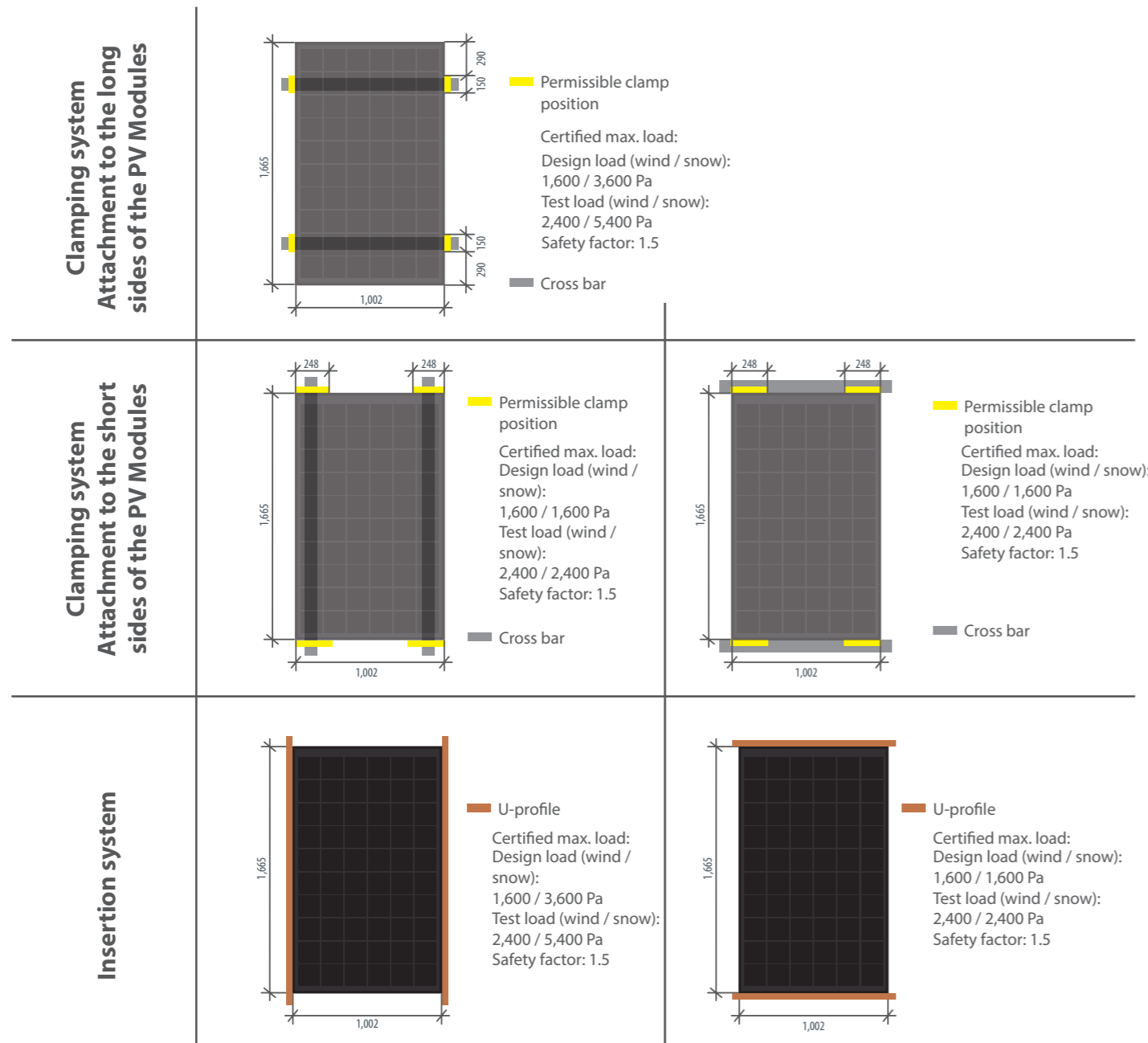

All the tests are made according to the IEC 61215:2016.

## 72-cell PV MODULES (cell dimension M0/M2 and G1)

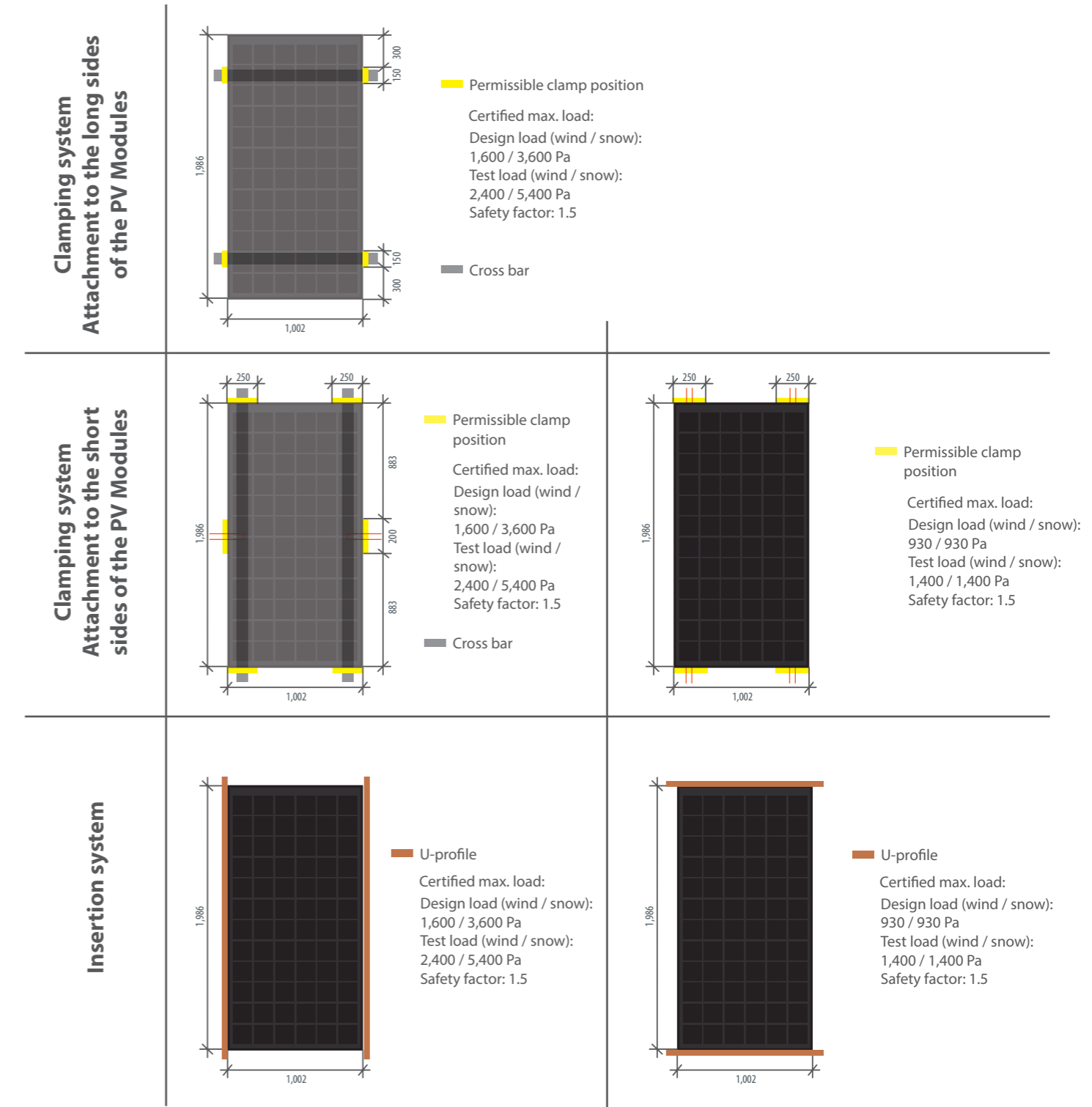

All the tests are made according to the IEC 61215:2016.

### 120-cell PV MODULES (cell dimension M6)

#### Clamping system Attachment to the long sides of the PV Modules

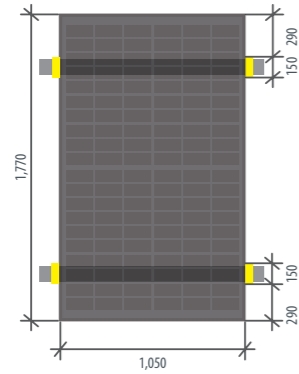

■ Permissible clamp position  
 Certified max. load:  
 Design load (wind / snow):  
 1,600 / 3,600 Pa  
 Test load (wind / snow):  
 2,400 / 5,400 Pa  
 Safety factor: 1.5  
■ Cross bar

#### Clamping system Attachment to the short sides of the PV Modules

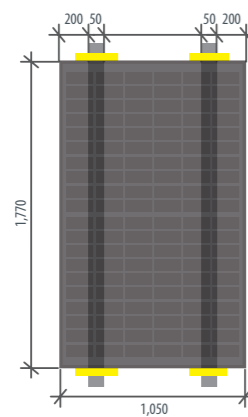

■ Permissible clamp position  
 Certified max. load:  
 Design load (wind / snow):  
 1,600 / 1,600 Pa  
 Test load (wind / snow):  
 2,400 / 2,400 Pa  
 Safety factor: 1.5  
■ Cross bar

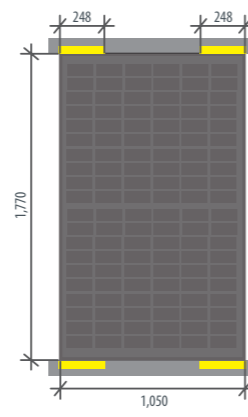

■ Permissible clamp position  
 Certified max. load:  
 Design load (wind / snow):  
 1,600 / 1,600 Pa  
 Test load (wind / snow):  
 2,400 / 2,400 Pa  
 Safety factor: 1.5  
■ Cross bar

#### Insertion system

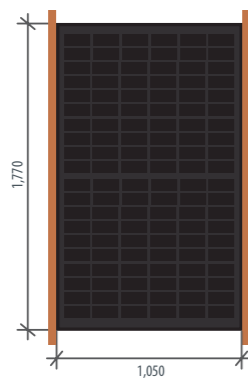

■ U-profile  
 Certified max. load:  
 Design load (wind / snow):  
 1,600 / 3,600 Pa  
 Test load (wind / snow):  
 2,400 / 5,400 Pa  
 Safety factor: 1.5

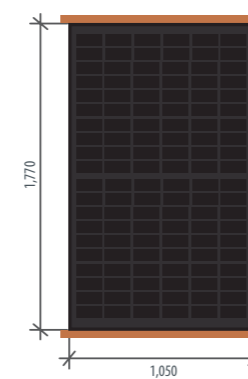

■ U-profile  
 Certified max. load:  
 Design load (wind / snow):  
 1,600 / 1,600 Pa  
 Test load (wind / snow):  
 2,400 / 2,400 Pa  
 Safety factor: 1.5

All the tests are made according to the IEC 61215:2016.

### 144-cell PV MODULES (cell dimension M6)

#### Clamping system Attachment to the long sides of the PV Modules

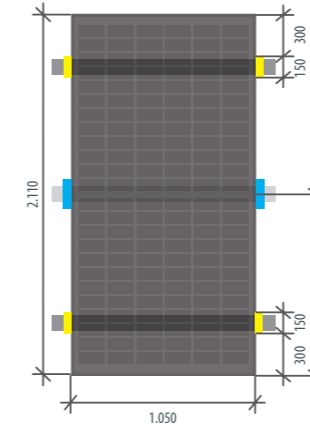

■ Permissible clamp position  
■ Permissible clamp position  
■ Cross bar  
 a = 950 ± 50  
 Safety factor: 1.5

Certified max. load:  
 Design load (wind / snow):  
 1,600 / 1,600 Pa  
 (4 clamps) ■  
 Test load (wind / snow):  
 2,400 / 2,400 Pa  
 (4 clamps) ■ → 35 mm frame  
 Design load (wind / snow):  
 1,600 / 3,600 Pa  
 (6 clamps) ■ + ■  
 Test load (wind / snow):  
 2,400 / 5,400 Pa  
 (6 clamps) ■ + ■ → 35 mm frame  
 Design load (wind / snow):  
 1,600 / 3,600 Pa  
 (4 clamps) ■  
 Test load (wind / snow):  
 2,400 / 5,400 Pa  
 (4 clamps) ■ → 40 mm frame

#### Clamping system Attachment to the short sides of the PV Modules

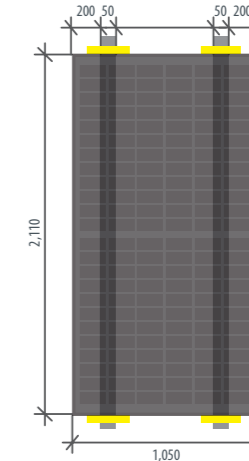

■ Permissible clamp position  
 Certified max. load:  
 Design load (wind / snow):  
 930 / 930 Pa  
 Test load (wind / snow):  
 1,400 / 1,400 Pa  
 Safety factor: 1.5  
■ Cross bar

#### Insertion system

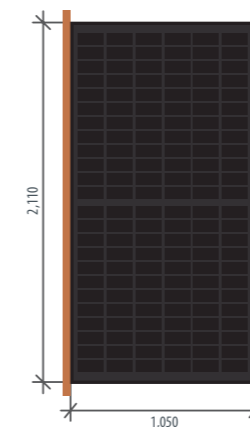

■ U-profile  
 Certified max. load:  
 Design load (wind / snow):  
 1,600 / 3,600 Pa  
 Test load (wind / snow):  
 2,400 / 5,400 Pa  
 Safety factor: 1.5

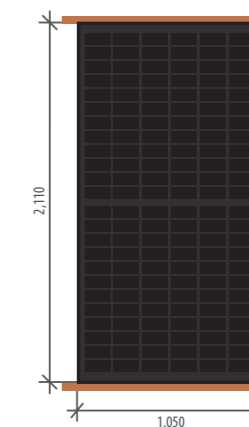

■ U-profile  
 Certified max. load:  
 Design load (wind / snow):  
 930 / 930 Pa  
 Test load (wind / snow):  
 1,400 / 1,400 Pa  
 Safety factor: 1.5

All the tests are made according to the IEC 61215:2016.

### 108-cell PV MODULES (cell dimension M10)

#### Clamping system Attachment to the long sides of the PV Modules

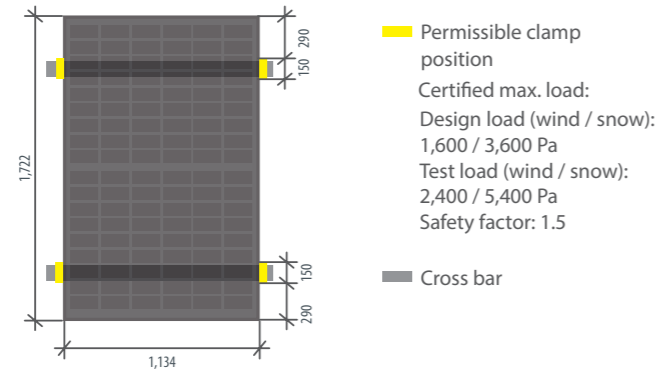

#### Clamping system Attachment to the short sides of the PV Modules

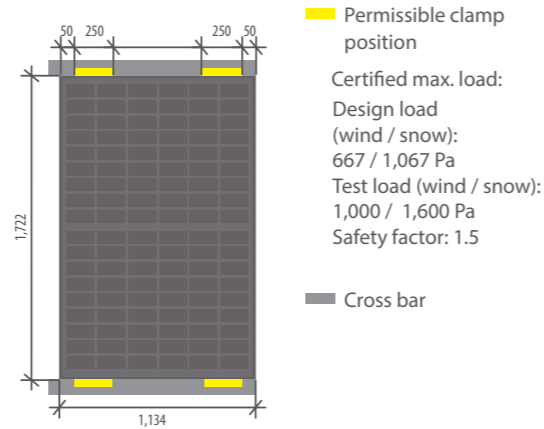
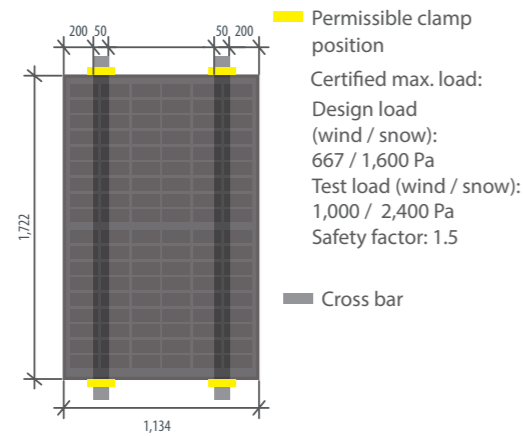

All the tests are made according to the IEC 61215:2016.

### 132-cell PV MODULES (cell dimension M10)

#### Clamping system Attachment to the long sides of the PV Modules

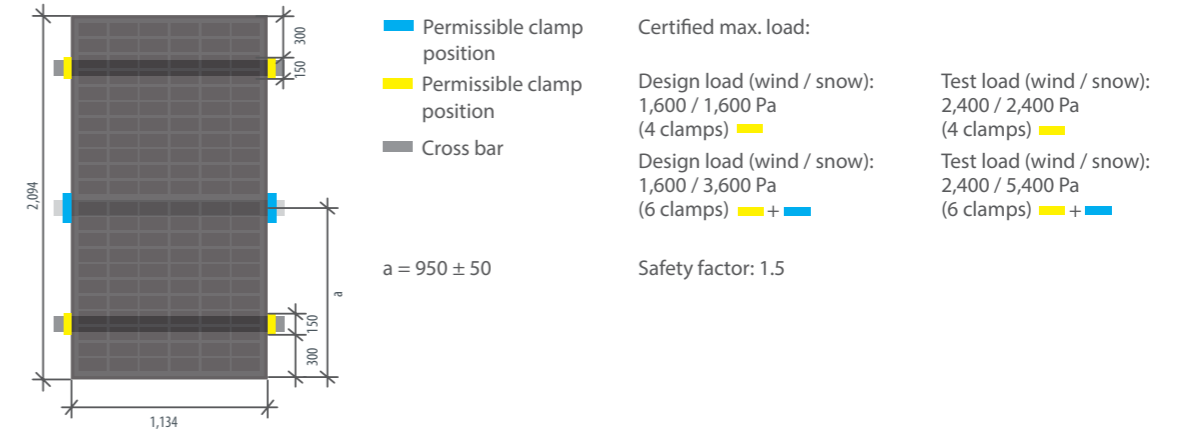

#### Clamping system Attachment to the short sides of the PV Modules



#### Insertion system

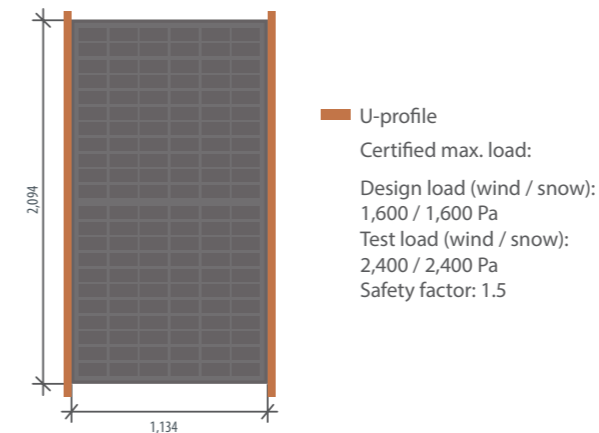

All the tests are made according to the IEC 61215:2016.



BISOL Production, Ltd.

🏠 Latkova vas | 59a SI-3312 Prebold | Slovenia

☎ +386 (0)3 703 22 50

✉ info@bisol.com

🌐 www.bisol.com

